

Start at the Source

*Design Guidance Manual
for Stormwater Quality
Protection*

1999 Edition

**Bay Area Stormwater
Management Agencies
Association**

B A S M A A



TOM RICHMAN & ASSOCIATES
Urban Design and Landscape Architecture

Start at the Source

*Design Guidance Manual
for Stormwater Quality
Protection*

1999 Edition

**Bay Area Stormwater
Management Agencies
Association**



Acknowledgements

This document was prepared for the San Francisco Bay Area Stormwater Management Agencies Association (BASMAA) New Development Committee.

BASMAA Participating Programs

Alameda Countywide Clean Water Program
Contra Costa Clean Water Program
Fairfield-Suisun Urban Runoff Management Program
Marin County Stormwater Pollution Prevention Program
San Mateo Countywide Stormwater Pollution Prevention Program
Santa Clara Valley Urban Runoff Pollution Prevention Program
Vallejo Sanitation and Flood Control District

Geoff Brosseau, Executive Director, BASMAA
Tom Dalziel, Chairman, New Development Committee

This document was first published as *Residential Site Planning & Design Guidance Manual for Stormwater Quality Protection* in January, 1997.

This current edition has been updated and expanded to include commercial, industrial, and institutional development, as well as a technical section to provide more detailed information on the characteristics, applications, design criteria, maintenance, and economics of the details that are discussed in this document.

This manual was developed under the guidance of a Review Committee comprised of representatives from regulatory agencies, planning and public works departments, builders, engineers, landscape architects and members of the academic community. We are grateful for all the comments and suggestions provided by the Review Committee in development of this document.

Thanks also to Professor Robert L. Thayer, Jr. of the University of California at Davis for providing guidance and counsel throughout.

Disclaimer

The contents of this publication are for general information only and are not intended to be a standard of the Bay Area Stormwater Management Agencies Association (BASMAA).

No reference made in this publication to any specific method, product, process, or service constitutes or implies an endorsement, recommendation, or warranty thereof by the authors, BASMAA, or its member agencies or consultants.

The authors and BASMAA make no representation or warranty of any kind, whether expressed or implied, concerning the accuracy, product, or processes discussed in this publication and assumes no liability.

Anyone using this information assumes all liability arising from such use, including but not limited to infringement of any patent or patents.

Consultant Team

This document was prepared by:

Tom Richman & Associates Tom Richman, ASLA, AICP
Patric Dawe, AIA
Jennifer Worth, ASLA

with **Camp Dresser & McKee** John Aldrich, PE
Tom Quasebarth
Jeff Endicott, PE

and **Prof. Bruce Ferguson**, FASLA of the University of Georgia.

Document design by **Artefact Design**.

Drawings by Patric Dawe. Photos by Tom Richman unless otherwise credited.

Review Committee

Todd Adair
Danny Akagi
Rodney Andrade
Oscar Balaguer
Shabnam Barati
Charlie Beck
Jill C. Bicknell
Bart Brandenburg
Geoff Brosseau
Carl Cahill
Mike Campbell
Dan Cloak
Gary Cullen
Liz Cullinan
Jagtar Dhaliwal
Tom Dalziel
Genevieve Fire
David Fowler
Jack Hall
Steven Hunte
Janice Jagelski
Roger James
Fred Jarvis
Lawrence Kasparowitz
Ron Killough
Keith Lichten
Jenny Linenberger
Roger Loftfield
Danielle Machotka
Peter Mangarella
Christine McCann
Gary Moore
Melissa Morton
Tom Mumley
Trish Mulvey
Heather Nelson
Michael Parenti
Ed Pancoast
Julie M. Pappa
Alex Pascual
Diane Pierce
Irum Shiekh
Bill Springer
Ken Strelow
Ramon (Ray) Towne
Tim Tucker
Marcel Uzegbu
Richard Watson
Steven Zeiger

Brian Kangas Foulk
City of Berkeley
MacKay & Soms
State Water Resources Control Board
Woodward-Clyde
City of Fairfield
EOA, Inc.
Central Contra Costa Sanitary District
BASMAA
City of Pittsburg
City of San Jose Planning Department
Santa Clara Valley URPPP
City of Hercules
City of San Carlos, Atherton
City of Berkeley Planning Department
Contra Costa Clean Water Program
Consulting Engineer
Harmony Homes
City of Antioch
Alameda Co. Public Works Agency
San Mateo County Planning
Woodward-Clyde
EOA, Inc.
County of San Mateo
Contra Costa Co. Building Inspection
CA Regional Water Quality Control Board
City of San Mateo
Centex Homes
Royston Hanamoto Alley & Abbey
Woodward-Clyde
Town of Danville
Alameda Co. Public Works Agency
Contra Costa Co. Public Works
Regional Water Quality Control Board
Friends of the Estuary
BASMAA
Woodward-Clyde
Urban Creeks Council
City of Pleasant Hill
City of Concord
Alameda County Planning Dept.
City of San Jose Planning Department
Santa Clara Valley Water District
City of Pittsburg
KCA Engineers, Inc.
City of Walnut Creek
City of Concord
Richard Watson & Associates
City of San Rafael



TOM RICHMAN & ASSOCIATES
Urban Design and Landscape Architecture
[now Catalyst: 415/267-5100]

Contents

Acknowledgments	ii	
How to use this book	viii	
1 Introduction		
The Hydrologic Cycle		
Regulatory Context		
Impervious land coverage as an environmental indicator		
Two approaches to stormwater management		
2 Concepts		
2.1 Every site is in a watershed		
2.2 Start at the source		
2.3 Think small		
2.4 Keep it simple		
2.5 Integrate the solutions		
3 Planning & Zoning		
3.1 Watersheds and planning – historical context		
3.2 Watershed-based planning & zoning		
3.3 Cluster/infill development		
3.4 Street design standards		
3.5 Parking requirements		
3.6 Community education and outreach		
3.7 SWMPs, SWPPPs, and BMPs		
4 Site Design		
4.1 Define development envelope & protected areas		
4.2 Minimize “directly connected impervious areas”		
4.3 Maximize permeability		
4.4 Maximize choices for mobility		
4.5 Use drainage as a design element		
5 Drainage Systems		
5.1 Drainage system design process		
5.2 Site conditions		
5.3 Soils		
5.4 Pollutants		
5.5 Drainage system elements		
5.5a Infiltration		
5.5b Retention and detention		
5.5c Biofilters		
5.6 System design techniques		
5.7 Water quality volume		
5.8 Manufactured treatment systems		
6 Site Design and Landscape Details		
Design Details Matrix		
6.1 Permeable Pavements		
6.1a Pervious concrete		
6.1b Porous asphalt		
6.1c Turf block		
6.1d Brick		
6.1e Natural stone		
6.1f Concrete unit pavers		
6.1g Crushed aggregate (gravel)		
6.1h Cobbles		
6.1i Wood mulch		
6.2 Streets		
6.2a Access street: urban neo-traditional standard		
6.2b Access street: rural standard		
6.2c Urban curb/swale system		
6.2d Rural swale system		
6.2e Dual drainage systems		
6.2f Concave median		
6.2g Cul-de-sac		
6.3 Parking lots		
6.3a Hybrid parking lot		
6.3b Parking grove		
6.3c Overflow parking		
6.3d Porous pavement recharge bed		

6.4 Driveways

- 6.4a Not directly-connected impervious driveway
- 6.4b Crushed aggregate driveway
- 6.4c Unit pavers on sand
- 6.4d Paving only under wheels
- 6.4e Flared driveways
- 6.4f Temporary parking

6.5 Buildings

Site coverage, floor area ratio

- 6.5a Dry-well
- 6.5b Cistern
- 6.5c Foundation planting
- 6.5d Pop-up drainage emitters
- 6.5e Building materials

6.6 Landscape

- 6.6a Grass/vegetated swales
- 6.6b Extended detention (dry) ponds
- 6.6c Wet ponds
- 6.6d Plant species selection for infiltration areas
- 6.6e Landscape maintenance for stormwater systems

6.7 Outdoor work areas

- 6.7a Garbage and recycling
- 6.7b Maintenance and storage
- 6.7c Loading

7 Case Studies

Economic benefits of stormwater management

7.1 Residential development

- 7.1a Small single lot
- 7.1b Large single lot
- 7.1c High density multi-family site
- 7.1d Small hillside site
- 7.1e Large hillside site
- 7.1f Large flat site

7.2 Commercial/industrial development

- 7.2a Shopping center
- 7.2b Industrial park
- 7.2c Strip mall
- 7.2d Schools and parks
- 7.2e Office building
- 7.2f Restaurant
- 7.2g Gas station
- 7.2h Hotel/motel

8 Technical Section

8.1 Permeable Pavements

8.2 Streets

8.3 Parking lots

8.4 Driveways

8.5 Buildings

8.6 Landscape

9 Next Steps

9.1 Frequently asked questions

9.2 Getting started

9.3 Keys to success

9.4 Resources

A Appendices

A.1 Glossary

A.2 Bibliography

A.3 Footnotes

Introduction by the Consulting Engineers and Land Surveyors of California (CELSOC)

BASMAA's second edition of "Start at the Source" focuses on the importance of considering storm water quality in the early stages of planning and designing new land development projects.

The implementation of permanent "best management practices" is the most recent newcomer to a list of activities which have stormwater quality as their goal. These efforts include heightening public awareness, care in construction practices, and the dedication of public agencies to increased maintenance efforts related to stormwater quality.

The planning of new projects is not only an activity conducted by planning and engineering professionals, it is equally an effort on the part of cities and counties to make sometimes-difficult choices among public benefits, which are often mutually exclusive. This process involves local agencies deciding what is most important to their community within a range of project acceptability and feasibility. Many of these conflicting issues are pertinent to the subject at hand, and are touched on in this guidance manual.

- Providing compact development may conflict with the idea of minimizing impervious area
- Engineering solutions to high groundwater and expansive soils conflict with the desire to trap and percolate storm drainage;

- Clustering residential density often conflicts with demonstrated preferences of homebuyers
- Reduced pavement widths often conflict with public safety issues
- The ideal of alternative means of transportation conflicts with Americans' love of their automotive freedom;
- The ever growing demand on limited public funds makes the maintenance of new pollution control systems difficult.

Most of all, the need for viable new development projects can conflict with local, regional, and other agencies' unfortunate vision of new growth as a source of revenue to help solve social and environmental problems which were either created by past practices or are more reasonably the responsibility of society in general. These "legacies" include diminishing wetlands, endangered species, school funding shortfalls, deteriorating transportation systems, lack of low cost housing, and even demands for child care. Adding stormwater quality to this list must be resisted.

We encourage Federal, State, and especially local agencies considering these guidelines to proceed in partnership with all sectors of private business and with the professional planning and engineering community to provide reasonable, equitable, responsible and cost effective means of improving water quality.

Rodney T. Andrade
subcommittee chairman

**Consulting Engineers and Land Surveyors
of California**

Consulting Engineers and Land Surveyors of California (CELSOC) is a statewide association of 850 professional engineering and land surveying firms in private practice which are dedicated to enhancing the consulting engineering and land surveying professions and protecting the general public.

Introduction by the American Society of Landscape Architects

Landscape architects are involved with design issues at every scale, from the setting of a catch basin to the layout of new towns. They deal principally with making places between buildings and the systems that link buildings and people together on the land. At the core of this place-making is grading and drainage—the shaping of the land to manage stormwater and accommodate human use.

Historically, grading and drainage design has largely neglected the environmental implications of stormwater runoff. In the past few years, we have begun to recognize the effect of stormwater runoff on environmental quality, especially on watershed and stream health. Today’s designers must consider not only flood control and protection of property, but also how to minimize the creation of new runoff, and how to minimize the pollutants carried in that runoff.

The link between development and the quality of our environment is becoming increasingly evident. Though considerable

professional attention has been given to direct stream and wetland protection, strategies for minimizing impacts of new development on watersheds have been less well articulated. This manual is an important step in showing how watershed protection can be achieved in urban and suburban development.

Through its integrative approach and illustrative method, “Start at the Source” shows how new development can be designed and built to meet functional and market demands while protecting water resources. It balances broad concepts with practical details. It provides a rationale for the design of places and the selection of building materials. It bridges the traditional gap between landscape architecture and civil engineering.

Finally, and perhaps most importantly, it shows how drainage systems can be integrated into overall site planning and landscape architecture to form the basis of practical, cost-effective, environmentally responsible, and aesthetically pleasing design.

Jim Dalton, Executive Vice President

American Society of Landscape Architects

The American Society of Landscape Architects is a professional association of over 11,000 members whose mission is “the advancement of the art and science of landscape architecture by leading and informing the public, by serving members, and by leading the profession in achieving quality in the natural and built environment.”

<http://www.asla.org/asla/>

How to use this book

This document is intended for use in the **planning and design** phases of residential, commercial, institutional and industrial development and redevelopment. It recognizes that one of the best opportunities to reduce the generation of urban runoff or “nonpoint source pollution” (see glossary) from development is through planning and design. Once developments are built, it is very difficult and expensive to correct land use patterns and storm drain systems that contribute to urban runoff.

Because the principles and techniques described here inform basic siting and design considerations, they will be easiest to incorporate and most effective if explored early in the planning and design phases of a project. Because of the wide variety of development sites in the Bay Area — such as infill, hillside, and redevelopment — and the wide array of regulations facing the development community, many of which are potentially in conflict with each other, this document suggests design and planning strategies for adaptation to each particular condition rather than defining specific solutions for every case.

During the **construction phase** additional strategies must be employed to minimize erosion and the introduction of other pollutants into stormwater runoff. These temporary strategies, such as silt fencing, straw-bales, and erosion control matting, are documented elsewhere. For information on stormwater management during the construction phase, see the *California Storm Water Best Management Practice Handbooks (Construction Activity)* and the *Manual of Standards for Erosion & Sediment Control Measures* by the Association of Bay Area Governments (ABAG).

After construction, other practices must be employed for proper management of properties and facilities to prevent introduction of pollutants into the storm drain system. These “best management practices,” such as proper storage and disposal of chemicals, recycling of used oils, and community education, are also treated elsewhere. For a principal source of information on best management practices after construction see the *California Storm Water Best Management Practice Handbooks*.

Along with planning, design, and management practices, effective **maintenance** and operation of control measures is as critical as proper selection and design. Many of the control measures and practices presented in this manual capture and retain stormwater pollutants. It is important to establish a maintenance and monitoring program to ensure that the systems function as designed, and that over the long term pollutants do not accumulate to unacceptable or toxic levels. Maintenance requirements for specific site design and landscape details are discussed in Chapter 8.

This guidance manual is not intended as a prescriptive document mandating that all projects adopt all the ideas presented here. Rather it is a menu of choices to illustrate a design philosophy and approach. Once the basic approach is understood, it is envisioned that each project team will adopt or adapt those solutions that best suit the unique circumstances of each site.

The approach presented here implies some different ways of handling stormwater. Answers to **frequently asked questions** can be found on page 150.

This manual is not intended as a prescriptive document mandating that all projects adopt all the ideas presented here. Rather it is a menu of choices to illustrate a design philosophy and approach.

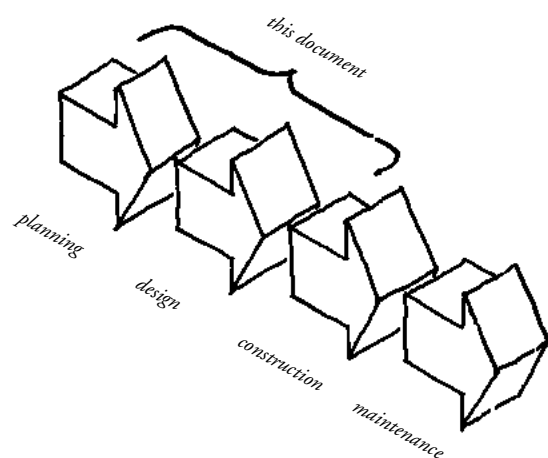

1 Introduction

This Manual has been prepared for the Bay Area Stormwater Management Agencies Association (BASMAA), an association of regional stormwater quality agencies around the San Francisco Bay and Delta.

Finding that the way we design and build communities has a direct effect on water quality, BASMAA has prepared this Manual with a focus on residential, commercial and industrial development, including new development, infill development and redevelopment. It aims to help designers, developers, and municipal agencies create communities that achieve water quality goals.

The Manual attempts to communicate basic stormwater management concepts and to illustrate simple, practical techniques to preserve the natural hydrologic cycle. These techniques are combined in a series of case studies to show how they may be integrated into projects. These case studies reflect the wide range of

geographical, hydrological and market conditions found in the San Francisco Bay area, and must be adapted to specific site conditions.

For planners, designers and engineers accustomed to approaching stormwater management as a challenge in controlling large concentrated flows, the approach presented here may require a shift in thinking. Rather than considering only the large, infrequent storms normally associated with drainage and flood control, this document focuses on the small, frequent storms that have the most impact on urban water bodies, and shows how controls for smaller storms can be integrated into a comprehensive drainage system. Also, rather than considering the generally more expensive and complicated end-of-pipe solutions, this document seeks to illustrate the simpler, more economical stormwater management opportunities presented by starting at the source.

The way we design and build communities has a direct effect on water quality.

The Hydrologic Cycle

The continuous circulation of the earth's water from sky to land to sea to sky is called the Hydrologic Cycle.¹

In its natural condition, soil is covered with a complex matrix of mulch, roots and pores which absorb rainwater. As rainwater infiltrates slowly into the soil, impurities are cleansed by natural biologic processes. Because most rain storms are not large enough to fully saturate the soil, only a small percentage of annual rainwater flows over the surface as runoff. What does become runoff usually travels in a slow meandering pace which allows suspended particles and sediments to settle. In the natural condition, the hydrologic cycle creates a stable supply of groundwater, and surface waters are naturally cleansed of impurities (although some sediment is carried with the flow) before arrival into the sea.

The impervious surfaces associated with urbanization prevent water from infiltrating into the soil. Even the smallest rainstorms

generate runoff, which collects pollutants and sediments, and is concentrated in narrow channels or pipes. This rapid, concentrated water flow can affect the hydrologic cycle in four ways: increased volume of flow which could mean increased flood potential, minimized impacts on channel destabilization, increased concentration of pollutants, and reduced groundwater levels.²

Builders can avoid these negative impacts by designing developments with stormwater systems that preserve and restore the natural hydrologic cycle.

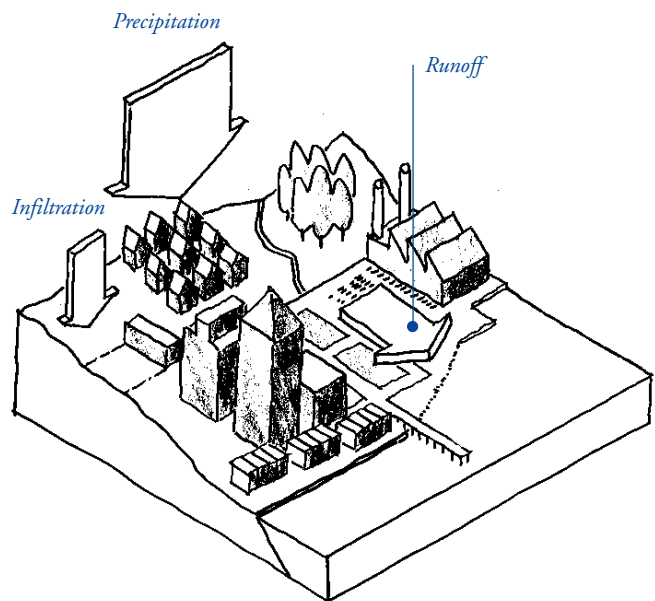
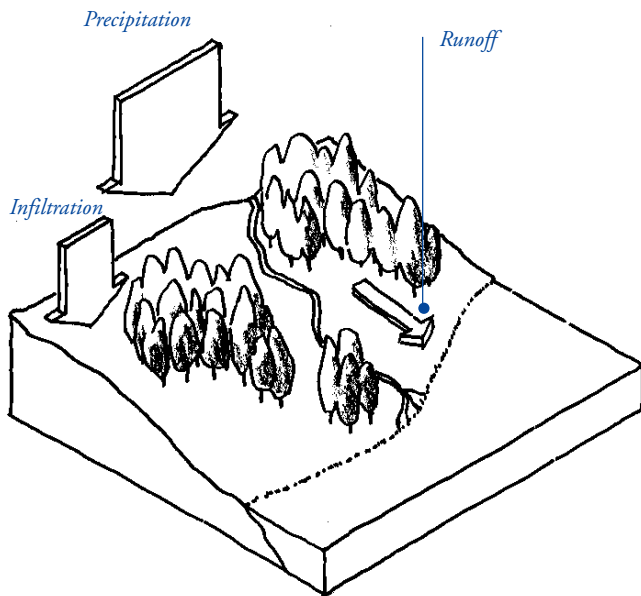

The hydrologic cycle

In **pre-development** landforms, a large percentage of precipitation infiltrates into the soil. A small percentage remains on the surface as runoff.

In **Post-development**, opportunities for infiltration are typically reduced, and a larger proportion of total precipitation becomes surface runoff.

Regulatory Context

As rain falls, it picks up pollutants from the air. Then as it becomes runoff it collects more impurities while passing over rooftops, streets, parking lots, landscaping, and gutters. This runoff typically enters a storm drain system that rapidly conveys it, untreated, to a lake, creek, river, bay or ocean. With the progress made in the past twenty-five years in controlling pollution from factories and other industrial point sources, this concentration of pollutants from various dispersed sources – nonpoint source pollution – is today responsible for over half of the water quality problems in waters of the United States.³

The Clean Water Act of 1972, as amended in 1987, prohibits the discharge of pollutants into waters of the United States unless the discharge is in compliance with a National Pollutant Discharge Elimination System (NPDES) permit. Most large population centers are already subject to NPDES permits, and smaller population centers may be required to comply in the next few years. Certain industries and construction projects specified by the U.S. Environmental Protection Agency must also obtain an NPDES permit in order to discharge stormwater runoff. Thus most Bay Area cities, and most large development projects, must comply with NPDES permit requirements.

The federal NPDES permit program requires that subject municipalities “develop, implement and enforce controls to reduce the discharge of pollutants from municipal separate storm sewers which receive discharges from areas of new development and significant redevelopment... [including] after construction is completed.”⁴

Within this regulatory context, developers and municipal permitting agencies are required to implement controls that reduce water pollution carried in runoff. These techniques may include storage (detention), filtration, and infiltration practices.

The Nationwide Urban Runoff Program and recent studies “indicate that planning and designing for the minimization of pollutants in stormwater discharge is the most cost effective approach to stormwater quality management.” Reducing pollution in stormwater by preventing or reducing the discharge of pollutants at the source is a technically sound and cost effective strategy to bring development into compliance with Federal law.

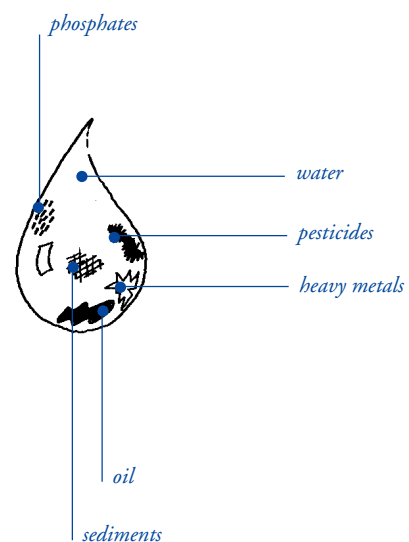
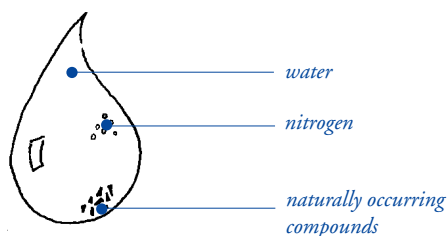

What's in a drop of runoff?

Pre-development runoff generally contains water and a low concentration of naturally occurring compounds.

Post-development runoff contains water and a variety of pollutants collected and concentrated from impervious surfaces.

Infiltration and the risk of groundwater contamination

The purpose of this manual is to encourage landscape designs and features that mitigate increases in site runoff by promoting infiltration through the soil. Allowing rain and runoff to infiltrate into the soil reduces the quantity of pollutants reaching local streams and San Francisco Bay. When implemented throughout a stream's watershed, infiltration protects the stream from increased peak flows, which can cause down-cutting, bank erosion, sedimentation, and losses to property and habitat. The Regional Water Quality Control Board encourages the use of infiltration as a strategy to manage urban runoff and to help protect the beneficial uses of streams and San Francisco Bay. Regional Board staff expects that, as part of their NPDES-permitted stormwater management programs, municipalities will encourage developers to implement the designs and methods described in this manual.

However, any drainage feature, including many of those described in this book, that infiltrates runoff poses some risk of potential groundwater contamination. The Regional Water Quality Control Board prohibits the unauthorized construction or use of any "artificial excavation for the purpose of extracting water or injecting water into the underground."⁵ The "Explanation of Policy" attached to Regional Board Resolution 81 states: "wells used to dispose of sewage and surface drainage bypass the normal processes of nature that occur at or near the surface of the soil. The use of such wells may allow for injection of waste into subsurface strata rapidly and unchanged in chemical quality." Illegal disposal of chemical wastes into dry wells and chemical spills have contaminated groundwater in some locations in the Santa Clara County. In some cases, the contamination is severe.

The risks associated with groundwater infiltration can be managed by:

- Designing landscape drainage features so that they promote infiltration of runoff, but do not inject runoff so that it bypasses the natural processes of filtering and transformation that occur in the soil.
- Taking reasonable steps to prevent the illegal discharge of wastes to drainage systems.

The designs in this book promote infiltration only to the top 10 feet of soil. In general, designs that disperse runoff over landscaped areas, or through permeable surfaces, are the most effective, easiest to maintain and have lowest initial costs. These designs also minimize the risks of illegal disposal because the surface is visible and the infiltration rate (per unit area) is relatively low.

For some sites, it may be feasible to use detention basins or dry wells to infiltrate additional runoff in a more compact area. When these techniques are used, the designer should consider the potential for illegal disposal or chemical spills. Detention basins and dry wells should not drain, or be located near, work areas where wash-waters or liquid wastes are generated or where hazardous chemicals are used or stored. If dry wells are used, there should be a sufficient thickness of unsaturated zone below the dry well to allow natural processes to function effectively. Detention basins and dry wells should be clearly marked with a "no dumping" message and should be inspected regularly by the municipal stormwater management program. In some jurisdictions, the local groundwater management agency may require that detention basins, dry wells and similar structures be permitted at the time of construction. Always check with the local groundwater management agency and municipality for construction standards and permitting requirements.

Impervious land coverage as an environmental indicator

A new environmental indicator is emerging to measure the health of urban watersheds — impervious land coverage.⁶

Impervious land coverage is a fundamental characteristic of urban and suburban areas. The rooftops, roadways, parking areas, and other impervious surfaces of development cover soils that, before development, allowed rainwater to infiltrate. By depriving the soil of its ability to infiltrate rainwater, a host of environmental consequences follow.

One of the environmental consequences of impervious land coverage is stream degradation. Impervious surfaces associated with urbanization cause stream degradation in four ways:

1. Rainwater is prevented from infiltrating into the soil, where it can recharge groundwater, reducing base stream flows.
2. Because it cannot infiltrate into the soil, more rainwater runs off, and runs off more quickly, causing increased flow volumes, accelerating erosion in natural channels, and associated reduction of habitat and other stream values. Flooding and channel destabilization may require construction to channelize the stream, with further loss of natural stream uses.
3. As runoff moves over large impervious areas, it collects and concentrates nonpoint source pollutants — pollution from cars, roadways, parking lots, rooftops, etc. — increasing pollution in streams and other water bodies.
4. Impervious surfaces retain and reflect heat, causing increases in ambient air and water temperatures. Increased water temperature negatively impacts aquatic life and reduces the oxygen content of nearby waterbodies.

Impervious surfaces can be defined as any material that prevents or reduces the infiltration of water into the soil. While roads and rooftops are the most prevalent and easily identified types of impervious surface, other types include sidewalks, patios, bedrock outcrops, and compacted soil. As development alters the natural landscape, the percentage of the land covered by impervious surfaces increases.

Roofs and roads have been around many years, but the ubiquitous and impervious pavement we take for granted today is a relatively recent phenomenon. A nationwide road census showed

that in 1904, 93 percent of the roads in America were unpaved. With the ascendancy of the automobile in the mid-twentieth century, the interstate highway system, and the growth of suburbia, the percentage of impervious surfaces increased dramatically. A prime contributor to the increase of impervious land coverage is the residential street network — since World War II, typical residential street widths have increased by 50%.

An increasing body of scientific research, conducted in many geographic areas and using many techniques, supports the theory that impervious land coverage is a reliable indicator of stream degradation. Furthermore, impervious land coverage is a practical measure of the impact of development on watersheds because:

- it is quantifiable, meaning that it can be easily recognized and calculated.
- it is integrative, meaning that it can estimate or predict cumulative water resource impacts independent of specific factors, helping to simplify the intimidating complexity surrounding nonpoint source pollution.
- it is conceptual, meaning that it can be easily understood by water resource scientists, municipal planners, landscape architects, developers, policy makers and citizens.

Water resource protection at the local and regional level is becoming more complex. A wide variety of regulatory agencies, diverse sources of nonpoint source pollution, and a multitude of stakeholders makes it difficult to achieve a consistent, easily understandable strategy for watershed protection. Impervious land coverage is emerging as a scientifically sound, easily communicated, and practical way to measure the impacts of new development on water quality.

This document illustrates a variety of site planning principles and design techniques for development. They all aim to reduce impervious land coverage, slow runoff, and to maximize opportunities for infiltration of rainwater into the soil.

Impervious land coverage thresholds

A certain amount of impervious land coverage is unavoidable in any development. Rooftops, by definition, must prevent infiltration of rainwater. Circulation systems— roads, parking, drive-ways— are the other, and usually most extensive, component of impervious land coverage. For planners, designers and regulators, the essential question is at what threshold of impervious land coverage does significant stream degradation begin?

Many recent studies have evaluated stream and wetland health using many criteria such as pollutant loads, habitat quality, and aquatic species abundance and diversity. These studies consistently show that significant water quality impacts begin at impervious land coverage levels of as little as 10%. At impervious land coverage over 30%, impacts on streams and wetlands become more severe, and degradation is almost unavoidable without special measures.

These impacts on stream health include:

- Creation of significant “new runoff,” because soil that would normally absorb rainfall is covered with impervious surfaces.
- Streams receive greater flows more frequently. For example, flow equal to a pre-development 2–year storm may occur every 2–3 months after development.
- The stream channel may need to enlarge itself to contain increased flows, causing stream bank erosion and loss of habitat.
- Stream bank erosion produces sediment which settles where and when velocities slow, covering aquatic vegetation and fish spawning beds, furthering the loss of habitat.

These studies suggest that three broad categories can be established using simple numeric thresholds illustrating the general relationship between impervious land coverage and stream health (exact thresholds/percentages may vary depending on region):

<i>Impervious land coverage</i>	<i>Stream health</i>
< 10%	“sensitive”
> 10 and < 30%	“degrading”
> 30%	“non-supporting”

Sensitive streams generally have stable channels, good water quality and good stream biodiversity. Degrading streams generally have unstable channels, fair water quality and biodiversity. Non-supporting streams may have highly unstable channels, fair to poor water quality and poor stream biodiversity.⁷

These impervious land coverage percentages must be measured across an entire site or development area. Sometimes lower overall impervious coverage can be achieved by clustering development at higher densities on one portion of a site, while maintaining open space elsewhere.

Given land values and population densities in the Bay Area, less than 30% overall impervious coverage may be difficult to attain in many basins of a water resource. Even in higher density developments, the impact of impervious land coverage can be mitigated by a variety of site planning and design techniques, which are illustrated in the following pages.

These techniques have three basic goals:

- to minimize overall impervious land coverage and maximize infiltration,
- to minimize as much as practical remaining impervious areas that are not-directly-connected to the storm drain system, and
- to slow runoff within a drainage system.

Two approaches to stormwater management

The conveyance approach to stormwater management seeks to “get rid of the water.” A conveyance stormwater system collects and concentrates runoff through a network of impervious gutters, drainage structures and underground pipes. As the conveyance system flows downstream, additional tributary conveyance systems feed into it, requiring it to be continually enlarged as it approaches its outfall. Because the system collects water from impermeable surfaces and carries it through impervious pipes, suspended pollutants are concentrated in the rapidly flowing runoff. When the system reaches its outfall, large volumes of polluted water can be emptied, untreated, into a natural water body.

Several factors contribute to stormwater degradation in a conventional development. Large paved roadway surfaces create and collect runoff. Building sites may be graded severely, removing natural vegetation that absorbs runoff. The curbs, gutters and catch basins collect runoff and carry it rapidly, providing little opportunity for infiltration. In this way, large quantities of runoff are created and carried in a short time to the outfall of a conveyance stormwater system, carrying sediments and other pollutants as a fast flowing untreated discharge into the bay.

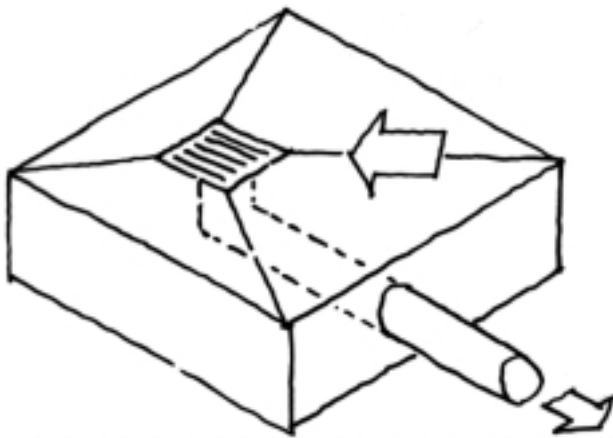

Conveyance Approach

The infiltration approach to stormwater management seeks to “preserve and restore the hydrologic cycle.” An infiltration stormwater system seeks to infiltrate runoff into the soil by allowing it to flow slowly over permeable surfaces. These permeable surfaces can double as recreational and landscape areas during dry weather. Because the infiltration network allows much of the runoff to return to the soil, overall runoff volume is reduced, and more water is available to replenish groundwater and maintain stream base flows. The slow flow of runoff allows pollutants to settle into the soil where they are naturally mitigated. The reduced volume of runoff that remains takes a long time to reach the outfall, and when it empties into a natural water body, its pollutant load is greatly reduced.

A development designed for stormwater quality generates less runoff because overall impervious land coverage is reduced through clustering and other means. Building sites are fit into the contours, and preserve vegetation as far as feasible. The drainage system attempts to slow runoff, and provides opportunities for it to filter into the soil. In dry weather these infiltration areas can be used for recreation or wildlife habitat. Smaller runoff volumes are created overall, and these volumes take a longer time to the outfall. When runoff from an infiltration-based system arrives, it's cleaner, and moving more slowly as it empties into the bay.

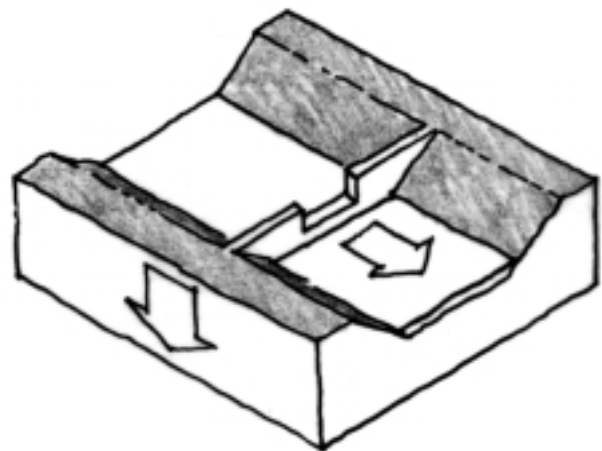

Infiltration Approach

2 Concepts

A few basic concepts form the foundation for drainage systems that preserve and restore the hydrologic cycle. Once these basic concepts are understood, the ingenuity of designers, planners and builders can be applied to invent specific techniques for the special requirements of any site.

The concepts spring from an integrated, comprehensive approach to stormwater management, considering each site's unique position within a larger watershed, and each smaller watershed within a site.

The application of these concepts consistently within a site will create a stormwater management approach that minimizes impervious area, reduces direct connections between impervious areas and the stormdrain system, and mimics natural systems while being economical, aesthetically pleasing, and technically sound.

Concepts

2.1 Every site is in a watershed. Rain falls on every site. What happens to the rain depends on the site's place in the larger watershed, and on the smaller watersheds within the site. From where does water enter the site? To where does it go? Understanding that a site has a position in the larger context is essential to stormwater management.

2.2 Start at the source. What happens immediately after a drop of rain hits the ground? Rather than convey stormwater away for treatment at the end of a pipe, water quality is most easily and economically achieved if stormwater management starts at the point that water contacts the earth.

2.3 Think small. For decades planners, engineers and builders have been trained to think big— to design systems that will handle peak flows from the biggest storms. Yet a significant amount of pollutants and flow-induced impacts to streams are in the early rains and small storms. Designing systems to accommodate the big storm is still essential for protection of life and property, but small-scale techniques, applied consistently over an entire watershed, can have a big impact — both improving stormwater quality and reducing overall runoff volume.

2.4 Keep it simple. A wide variety of simple and effective strategies can be employed to achieve stormwater quality goals. Designed for the small storms, these simple strategies often use natural methods and materials, and sometimes require a different kind of engineering or maintenance than conventional modern drainage systems. By employing an array of a few simple techniques throughout a site, improved stormwater management can be achieved economically with modest maintenance requirements, and can often be cost-effectively integrated into larger, flood control-type facilities.

2.5 Integrate the solutions. Providing stormwater management facilities is not a problem — it's an opportunity. By integrating solutions into the overall site plan, stormwater facilities can provide recreational, aesthetic, habitat, and water quality benefits.

Every site is in a watershed

Once a single drop of rain reaches the earth, its journey is determined by the watershed in which it lands. A watershed is defined by the U.S. Environmental Protection Agency as “the geographic region within which water drains into a particular river, stream, or body of water.”⁸

A small puddle in an uneven field reflects a tiny, localized watershed. At a neighborhood scale, gradual changes in elevation, or man-made artifacts like roadways or railroad embankments may define watersheds. Regionally, a range of mountain ridges may create a watershed that is drained by a network of small streams and creeks, each of which forms a tributary to larger water bodies, forming larger watersheds, all of which ultimately empty into a lake, bay or ocean.

No matter where you are in a watershed, or at what scale of watershed you are working, what you do on any particular site always has effects on the overall hydrologic system. By understanding that every site has a relationship to its adjoining watersheds, by investigating the soil and hydrologic conditions of the site, and by appreciating the micro-watersheds within each site, designers can best achieve the overall objective: restoration and preservation of the natural hydrologic system.

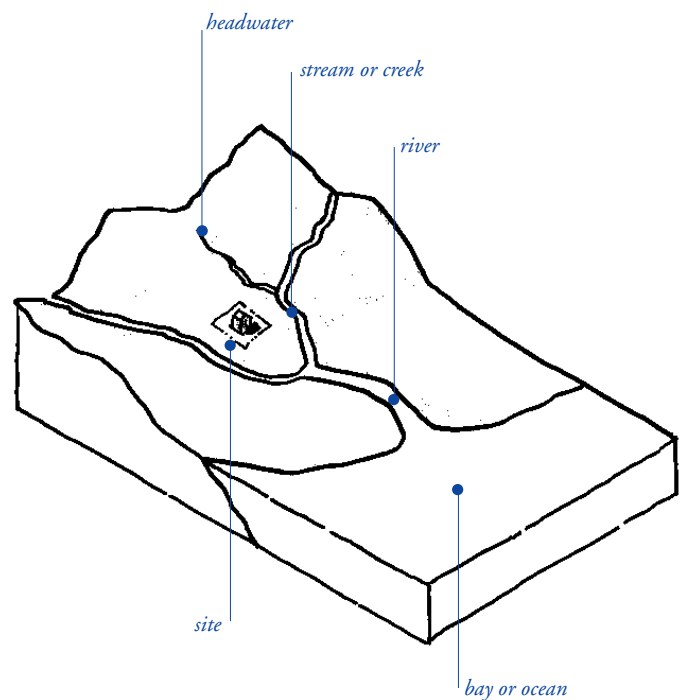

Start at the source

When a single drop of rain lands, it is carried by gravity and soil physics downward into the soil.

If the soil is covered with an impervious material, such as rooftops, concrete, or asphalt, the single drop of rain flows along whatever surface it encounters, moving downhill, joining with other drops of rain to create runoff.

If this runoff is collected in pipes and conveyed long distances before treatment many opportunities for improved water quality are lost. “End of pipe” strategies, such as large retention ponds, can be important components of an overall stormwater management system, but are more complex and costly than strategies that start at the source.

Small collection strategies, located at the point where runoff initially meets the ground, repeated consistently over an entire project, will usually yield the greatest water quality improvements for the least cost.

Source control is cheapest

If runoff is infiltrated or detained at its source (a) the least costs are incurred and maintenance is minimal. If runoff is carried some distance and treated enroute (b), costs and maintenance demands rise. If runoff is carried directly to the outfall (c), cost for treatment controls are highest and most maintenance intensive.

The most economical, simplest stormwater management opportunities for water quality are at the source of the runoff.

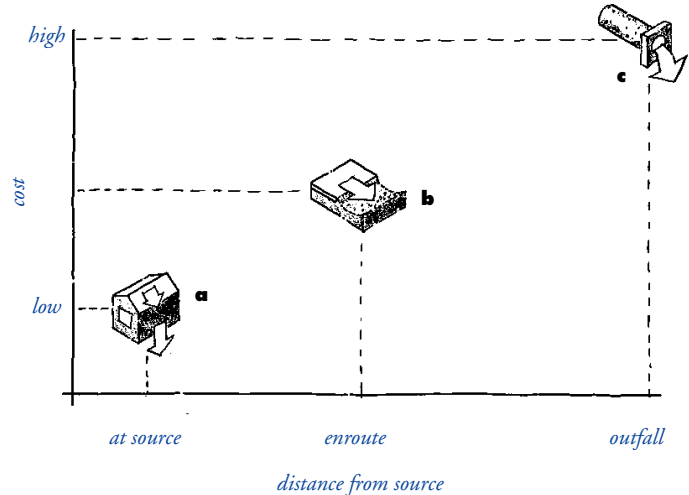

Think small

Small storms add up. Because of their frequency, small storms, meaning storm sizes that recur once every two years or more frequently, produce the vast majority of total runoff over time. In the Bay Area, small storms account for eighty percent of total annual rainfall.

By targeting these small storms, rainfall can be managed for water quality through relatively small water quality systems. In this way, managing frequent small storms can address a large part of the pollution problem.

In the past, stormwater management has focused almost exclusively on flood protection. In the same way that a freeway designed for rush hour traffic can easily handle the traffic on a quiet weekend morning, stormwater systems that can accommodate flood flows are more than adequate to convey more frequent small storms. So, in designing only for flood protection, designers have been able to neglect the small storm and its impacts.

With an awareness of the importance of small storms for water quality protection designers now consider small storms, because of their frequency and cumulative impacts, as well as the infrequent large rainfall event.

Small storms add up

Rainfall is distributed between relatively infrequent large storms and more frequent small storms. For example, in the Bay Area, approximately eighty percent of the total annual rainfall is produced by the accumulated contribution of the many small storms, the size that recurs every two-years or less (two-year recurrence interval). These small storms typically produce between 0.5 to 1.25 inches of rain, depending on microclimate. By comparison, all of the larger storms combined (five, ten, twenty and fifty year intervals) typically produce less than twenty percent of the total annual rainfall.

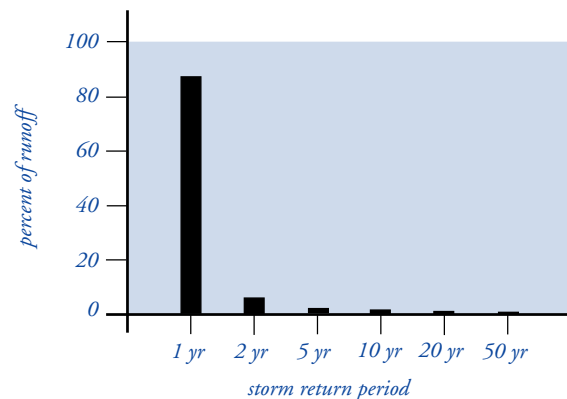

Keep it simple

The techniques illustrated in this document were purposefully kept simple. Being simple, they are easy to understand. They are also relatively easy and inexpensive to design, build and maintain.

To address the many diverse sites found in the Bay Area, this document illustrates a wide variety of techniques, applicable to different soils, sites, and conditions. It is not intended that all the techniques illustrated here will be appropriate for each project, but instead, that planners, landscape architects, and engineers select and adapt those few that are most suited to a particular site.

A simple gravel strip, a concave instead of convex planting area, an infiltration basin at the end of a downspout — all of these are simple, but effective strategies for integrating stormwater management into a site plan.

The best stormwater management system will rely on a few simple techniques, applied consistently over an entire project or site.

Simple but effective

Because most stormwater management has generally been focused on complex, large systems, small, simple solutions may appear at first glance less effective. Yet simple solutions can be just as effective, and must undergo the same rigorous engineering analysis as more complex approaches. The difference is that the simple systems generally use lower technology materials and rely on natural materials integrated with the landscape, rather than mechanical or man-made processes, to manage stormwater.

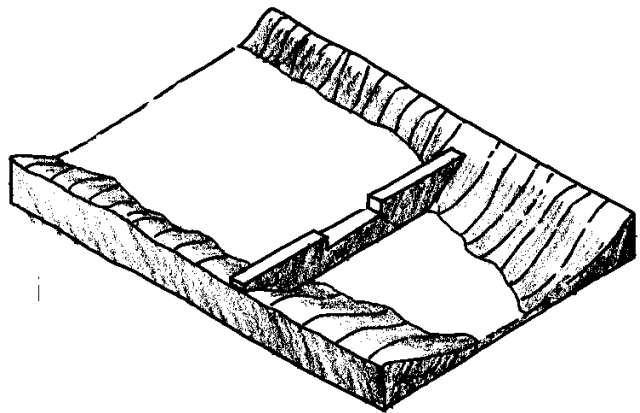

Integrate the solutions

The stormwater management system can become an organizing element for site planning and design. Infiltration devices, drainage swales, and retention areas can be integrated into a site plan to improve aesthetics and provide recreational resources.

For example, a landscaped area, if slightly concave or depressed, can also serve as a temporary detention basin. Drainage swales can be landscaped with attractive riparian species. Pathways can follow these swales, creating attractive greenbelts that reflect natural landforms. A sandy area can serve as a children's playground in the dry season, but become a shallow infiltration basin in the winter rains.

Home buyers and business tenants consistently indicate a preference for water features. A network of small ephemeral pools and swales, treated carefully with attractive planting and maintenance, can satisfy this desire for a relationship to water and give developments a competitive advantage.

An integrated site plan will generally yield a series of smaller stormwater management facilities rather than one large basin at the end of a traditional conveyance system. This integrated approach not only reduces cost while achieving environmental goals, but it also maximizes land values, improves marketability, adds aesthetic interest, and provides increased recreational opportunities.

Design out the hazard, design in the people

Often environmentally sound stormwater management facilities, such as retention basins, are fenced or hidden from view. This approach to stormwater management not only adds significant “opportunity costs” through lost building sites or recreational potential, but also sends a symbolic message that stormwater is hazardous.

There are legitimate concerns for safety and liability, but they can usually be mitigated through simple design strategies such as shallow basin depths and gently sloping sides. By designing out the hazards and designing in the people, most drainage features can be integrated into the site plan to mimic the natural hydrologic cycle, add aesthetics, and increase recreational value.

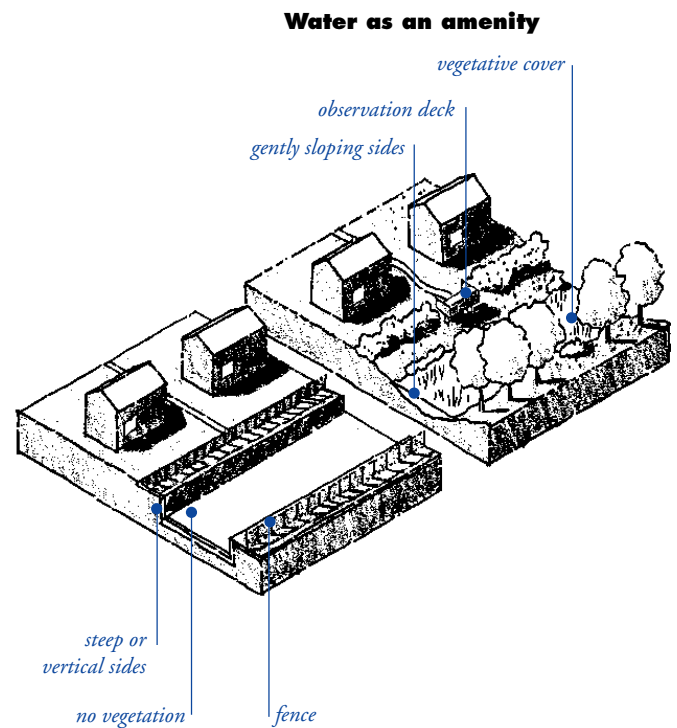

Water as a hazard

3 Planning & Zoning

Planning and zoning practices profoundly influence the impact of development on watersheds.

Planning determines the pattern of development, what type is permitted, and its relationship to streams and other natural features. Zoning determines where particular land uses are located, requirements for parking, sizes of roadways, permitted impervious land coverage, and types of approved drainage systems.

By understanding how these powerful tools work, they can be focused to protect water quality.

Planning & Zoning

3.1 Watersheds and planning - historical context.

Political decisions made a century ago affect our ability to plan for watershed quality. Understanding the historical context of watershed planning helps us to focus current efforts more effectively.

3.2 Watershed-based planning & zoning. Conventional zoning practices don't typically address the impact of development on water quality. Specific zoning approaches can be adopted to make zoning a more effective water quality tool.

3.3 Cluster/infill development. Clustering development at higher densities on a portion of a site can have a beneficial impact on overall watershed health. The denser area may have a very high percentage of impervious land coverage, but total impervious area and land disturbance will be less.

3.4 Street design standards. Streets comprise a very large proportion of land use – up to 25% of total land area. The street pavement itself is often the largest component of total impervious land coverage. A carefully designed street system can protect water quality while also serving its primary transportation function.

3.5 Parking requirements. Parking is often the greatest single land use, and usually it is made of impervious pavement. The amount of parking mandated by zoning codes and standards often far exceeds the usual parking demand. A variety of zoning and planning tools are available to provide adequate, but not excessive, parking supply.

3.6 Community education and outreach. Education and outreach are critical elements of designing for water quality protection. Generating public awareness increases general interest and acceptance and improves long-term maintenance prospects.

3.7 SWMPs, SWPPPs, and BMPs. An alphabet soup of acronyms define government regulations relating to storm-water quality protection. Understanding these regulations is a key to successfully navigating the approval process.

Watersheds and planning – historical context

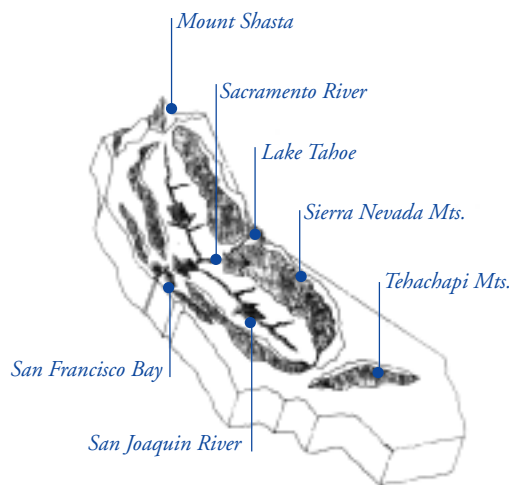

SF Bay drains a vast watershed

In 1878, Major John Wesley Powell, the first Director of the United States Geological Survey, submitted his *Report on the Lands in the Arid Region of the United States* to the U.S. Congress on the future of the American west. In this document, Powell recognized that water would be the limiting resource in the future development of the arid west. He understood that the rectilinear surveys used to divide properties and political entities in the rainy east would not work in the drier west. Instead of boundaries drawn along arbitrary lines, Powell proposed that drainage divides, or watersheds, be the organizing land use principal.

Congress ignored Powell's recommendation, continuing its practice of dividing properties and political entities along arbitrary lines. Where waterways such as rivers or creeks were used for creating political divisions, they often were used to form the border between entities. Yet, ecologically speaking, waterways do not divide land, but unite it by collecting drainage from throughout the watershed. Thus, in the adopted planning system, the political function of a waterway is often precisely opposite to its environmental function.⁹

These kinds of political and jurisdictional barriers to watershed planning also effect the San Francisco Bay, which drains a vast regional watershed extending from the coast ranges in the east to Mount Shasta in the north to Kern County in the south to Lake Tahoe in the east. County and city jurisdictions occasionally follow watershed boundaries (like the Mayacmas ridge separating Sonoma from Napa County), but more often lie in the

center of watersheds (like San Francisquito Creek which divides San Mateo from Santa Clara County).

As planners and scientists recognize the threats to water quality, they create new mechanisms to better facilitate watershed-based planning and zoning. These include specific efforts to protect specific streams, such as the San Francisquito Creek Watershed Coordinated Resource Management Process, a collaboration between two counties and multiple cities along San Francisquito Creek, as well as larger regional efforts, such as the Santa Clara Basin Watershed Management Initiative, the Alhambra Creek Watershed Program, the Alameda Creek Watershed Management Program, many regional water quality programs, BASMAA, and the Association of Bay Area Governments (ABAG).

In Powell's scheme, the San Francisco Bay Area would have been treated as a single political entity, and the counties within it would have been divided on the basis of sub-watersheds, protecting the precious water resource and making environmental planning much easier.



Major John Wesley Powell (on horseback) proposed that watersheds be the organizing land use principal in the arid west.

(photo by Smithsonian Institution)

Watershed-based planning & zoning

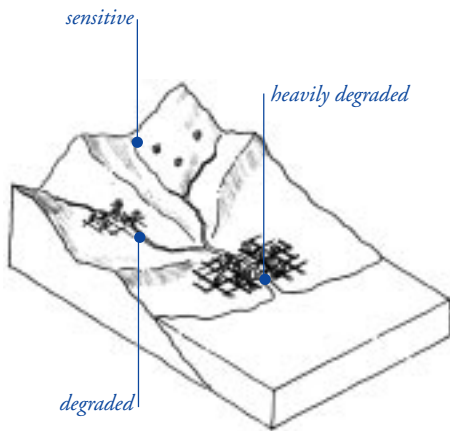

Land use patterns and the types of development permitted are determined by the planning process, which considers social, political, institutional, natural and other factors. In all planning and zoning, protection of natural resources must be balanced with other community priorities such as roads, schools, housing and economic development.

Limits of conventional planning and zoning. Conventional planning and zoning can be limited in their ability to protect the environmental quality of creeks, rivers and other waterbodies. This is a result of two principal factors. First, conventional zoning arises from political, transportation, and social factors that often do not mirror the natural watershed boundaries of a community. Second, conventional zoning can limit development by density (units per acre or allowable square footage). These regulations often address the maximum density of rooftop impervious cover, but have limited impact on the transportation network's contribution to impervious land coverage (roads, parking, pathways, driveways, etc.). Because this transportation component is usually greater than the rooftop component of impervious land coverage, density is an indirect and imprecise measure of forecasting the effect of development on water quality.

State planning law offers guidelines for resource protection but does not require specific protection measures. Local governments consider various priorities to develop General Plans that guide growth over a relatively long time horizon, such as twenty or thirty years. In some instances, local governments may consider the relationship of development to natural features such as creeks

and hillsides, and may guide land use changes to minimize impact to these features. These local considerations may differ from city to city and can be difficult to coordinate regionally. In some local jurisdictions, natural factors may only be addressed to the extent of identifying hazards and land that is not suitable for development, while other jurisdictions may set a higher value on natural resource protection. Regardless of the approach of any particular local planning jurisdiction, the priorities of complex natural systems can be difficult to address at the local level, making a balanced pattern of development and resource protection at the regional level difficult to achieve.

Watershed based planning. An alternative to conventional planning and zoning is natural resource and watershed-based planning. Because such planning is natural resource-based, it begins by considering the natural resources of a given area. By being watershed-based, it orients such considerations to watershed areas, rather than only within town, city, or county lines. Such planning enables multiple jurisdictions to work together to plan for both development and conservation that can be environmentally as well as economically sustainable.

The regional approach is inherently difficult because it involves balancing the interests of many independent local governments. When practiced effectively, however, regional resource-based planning enables local and regional areas to realize economic, social and other benefits associated with growth, while conserving the resources needed to sustain such growth, including water quality.

This kind of comprehensive planning involves four basic steps:

- identify the watersheds shared by the participating jurisdictions,
- identify, assess, and prioritize the natural, social and other resources in the watersheds,
- prioritize areas for growth, protection and conservation, based on prioritized resources, and,
- develop plans and regulations to guide growth and protect resources.

Watershed-wide plans can become very detailed, with in-depth data gathering and assessment, extensive public involvement, identification of problems and needs, development of management strategies, and long-term implementation of policies and actions. Local governments, however, can start with simpler yet important steps toward effective watershed planning, such as adopting a watershed-based planning approach, articulating this basic strategy in their General Plans, and beginning to pursue the basic strategy in collaboration with neighboring local governments who share the watersheds.

Watershed-based zoning. Some watershed protection strategies have been adopted under conventional zoning, but they typically have limited value. These strategies include large lot residential zoning, which can reduce the overall impervious area on individual lots, but expands the impervious coverage of the roadway network as well as contributing to urban sprawl.

Another approach is the widespread use of stormwater treatment devices (often called BMPs) to mitigate the impact of impervious land coverage. These devices, even in the best of circumstances, have limited value as a watershed protection strategy, and their performance is often compromised by poor design, construction, or lack of maintenance.

Some resource-based zoning policies that can be developed and incorporated into conventional zoning include:

- overlay districts,
- performance zoning,
- incentive zoning,
- imperviousness overlay zoning,
- planned unit development zoning.

The intent of each of these tools is to introduce flexibility into the zoning structure to encourage natural resource protection.

Restoration. In many cases, municipalities undertake efforts towards preservation or restoration of existing natural resources, such as streams or other water bodies. In areas with the highest levels of existing urbanization, streams may have been impacted so that they don't support habitat in their present degraded condition. It is usually not practical in these circumstances to restore degraded streams to a pristine pre-development condition, with full habitat and ecological function. In these cases, an "urbstine" condition, or one of enhanced environmental vitality consistent with the urban context, may be sought. Planners can work with the community, water quality engineers and wildlife fisheries biologists to define the criteria for an "urbstine" condition, and work to achieve those goals.

Efforts to restore biological diversity may include:

- preventing the introduction of urban pollutants to protect downstream waters,
- mitigating effects of development using biofilters, detention/infiltration basins, pervious pavements, and other strategies,
- retaining the natural riparian corridor and carefully applying measures to prevent or treat runoff,
- protecting and restoring creekbank vegetation,
- restoring the riffle/pool structure and meander length,
- preventing unauthorized diversions of water.

Ideally, General Plans need to look at development projects in the context of the entire watershed, considering site impacts in terms of an overall watershed plan.

Cluster / infill development

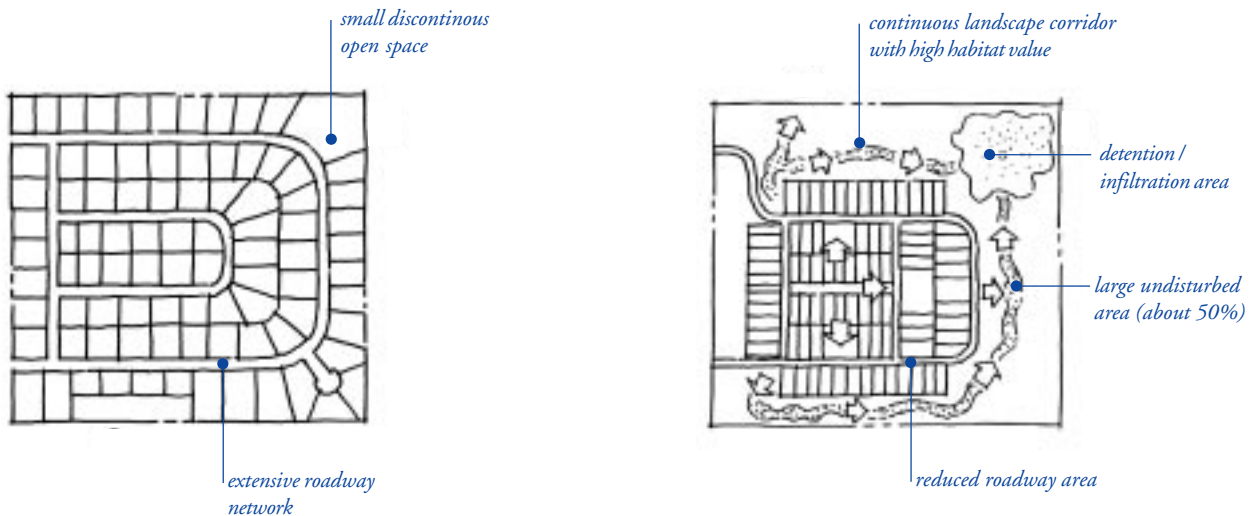

Conventional development standards use setbacks, frontages, roadway geometry, and other methods to arrange individual buildings on individual lots. Development based on the individual lot usually creates a homogeneous community, an extensive roadway network and other infrastructure systems.

Cluster development, a site planning technique in use for several decades, considers not only individual lots, but larger site boundaries. It concentrates development on one portion of a site, and conversely maintains more of the site in open space. One of the principal results of cluster development is reducing the length of the roadway network. Because the other infrastructure elements, such as sewer, power, telephone, and water follow the roads, their costs are also reduced. This means that cluster development can be significantly less expensive to build than conventional single lot development. On-going costs for city services, such as police and fire protection, are also reduced, because the community is more concentrated and therefore more efficiently served. Finally, cluster development provides increased area for passive recreation, because the open space is concentrated in a public or semi-public place, rather than divided in many large, private yards. However, cluster developments can face resistance in the marketplace, because home buyers sometimes prefer the larger lot sizes and wider streets of conventional development patterns.

From a water quality viewpoint, cluster development has multiple benefits compared to conventional zoning. These include:

- reduced impervious surface area by 10 to 50%,

- reduced stormwater runoff,
- reduced encroachment on stream buffers,
- reduced soil erosion since 25 to 60% of site is never cleared and steep hillsides are avoided,
- reduced need for expensive flood control measures,
- larger urban wildlife habitat islands, and,
- reduced reliance on automobiles, because shorter distances make pedestrian, bicycle and mass transit more attractive.

Most cluster development zoning policies have not been explicitly created to support water quality protection. To enhance these benefits, proponents of cluster development for stormwater quality protection have suggested the following cluster development criteria:¹⁰

- significant impervious surface reduction from reduced roadway network compared to conventional zoning,
- minimum site size (approximately 5 acres),
- minimum open space requirement of approximately 50% of total site,
- consolidation of open space, such that at least 75% is in a contiguous unit for habitat value,
- maintenance of approximately half of the open space in undisturbed vegetated areas (i.e. wetlands, forests, meadows), with the other half as a community green space (i.e. turfgrass, playgrounds, constructed stormwater basins),
- formation of private legal entity to maintain open space in perpetuity (e.g. homeowner's association), and,
- dedication of open space to a public open space district.

Street design standards



A typical pre-war residential street

28 foot wide with tree-lined parkway between the curb and sidewalk. This traditional design can be found in older neighborhoods throughout the Bay Area.



A typical post-war residential street

36 foot wide with no parkway between sidewalk and curb. This modern design can be found in newer neighborhoods throughout the Bay Area.

Streets are at the nexus of a wide variety of land use and environmental issues. An understanding of their scope, history, and function helps to explain their central importance in the design of development for stormwater quality.

Considered a number of ways, the street is a large design element. In a typical neighborhood, the public right-of-way – the street – comprises approximately 20 to 25% of total land area, making it the single most important determinant of neighborhood character. Streets also can comprise up to 70% of a community's total impervious land coverage, with the remainder of impervious land coverage from rooftops and other structures. This can make street design the single greatest factor in a development's impact on stormwater quality. Because the street exists in the public right-of-way, it comprises a large proportion of total public open space in a typical development. It is also subject to municipal ordinances, standards, and management, giving local jurisdictions a great deal of control over street design. For these reasons, the street is the one of the most important design elements in site planning, and an element that can be most directly affected by local ordinances and policies.

Residential streets. Residential streets present a significant opportunity to apply design for water quality. Unlike streets in commercial and industrial settings, which must be sized to ac-

commodate large trucks, high speeds, and heavy volumes, residential streets typically are intended for low volume, low speed automobile traffic.

Prior to World War II, traditional residential streets were designed as multiple use spaces, shared by pedestrians, children at play, animals, and low volumes of vehicular traffic traveling at low speed. The prototypical residential subdivision, laid out by Frederick Law Olmsted at Riverside, Illinois, in 1869, has 24 foot wide streets with concrete curb and gutter, lined with broad 12 foot wide parkway strips planted with trees. Outside of the parkway strip is a 5 foot wide sidewalk on both sides.¹¹ This model was copied all over the United States, and many pre-war neighborhoods can be found today with similar traditional street geometries.

After World War II, new street standards were developed to facilitate the automobile, which was growing both in dominance and number. Standards set by professional associations such as the Institute of Transportation Engineers (ITE) and the American Association of State Highway and Transportation Officials (AASHTO) as well as rules promulgated by the Federal Housing Administration increased paved area by up to 50% compared to pre-war designs, setting typical residential street width at 36 feet, plus curb, gutter and 5 feet of sidewalk on both sides.¹²

Street design standards, continued

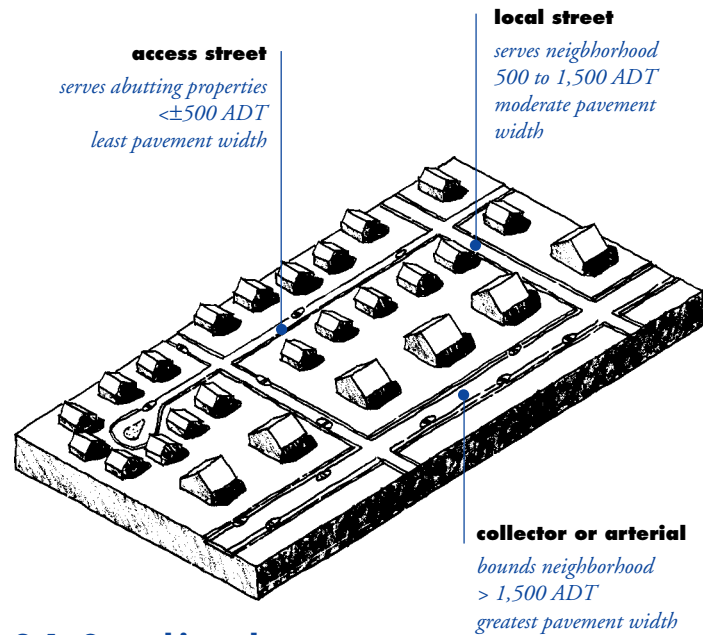

3.4a Street hierarchy

These standards were applied in communities throughout the Bay Area and the United States. For ease of maintenance, many communities abandoned the parkway strip between the curb and sidewalk, bringing the sidewalk flush with the back of the curb and eliminating the street trees. In a typical 50 foot wide right-of-way, this 46 foot wide pavement section (36 feet of street plus 10 feet of sidewalk) creates 92% impervious land coverage in the right-of-way. Compared to the inviting, park-like space of the original Olmsted model, with its 57% impervious land coverage (34 feet of pavement inside a 60 foot right of way), the modern residential street with its 90% impervious coverage can be a hot, treeless place that generates significant runoff.

Today professionals from many fields, including transportation engineers, landscape architects, urban designers, and environmental scientists, are reevaluating residential streets with the intent of creating new standards that are more hospitable and more environmentally responsible. New street standards based on the pre-war models (known as “neo-traditional design”) are now being studied and adopted in municipalities across the country. At the national professional level, ITE has published neo-traditional street standards that permit local streets between 22 and 30 feet wide, allowing parking on both sides, with or without curbs.

3.4a Street hierarchy. Municipal standards generally classify street widths by the planned function of the street: local, collector or arterial. *Local streets*, the smallest class, are intended to provide access to abutting properties, and have a typical average daily traffic (ADT) of less than 1,500 vehicles. By definition, through traffic and truck traffic are generally discouraged on local streets. *Collector streets* are an intermediate class, intended to collect traffic from local streets and deliver it to larger arterial streets. They also can serve as the primary traffic route within a residential or commercial area, and have a typical ADT between 1,500 and 3,000. Finally, the largest class (except highways and freeways), *arterial streets*, have an ADT between 3,000 and 10,000, and are intended to provide long distance travel, with controlled intersections and higher speeds. For residential design, local streets are most relevant.

A survey of Bay Area municipalities reveals that the **typical current standard** for a two-way local street with parking on both sides requires two moving lanes, plus two parking lanes, plus curb, gutter and sidewalks each side, making a total of 40 to 50 feet of pavement within a typical 50 foot right-of-way (see table).

Yet, the number of vehicle trips on a local street can vary considerably, depending on the number of abutting dwelling units.

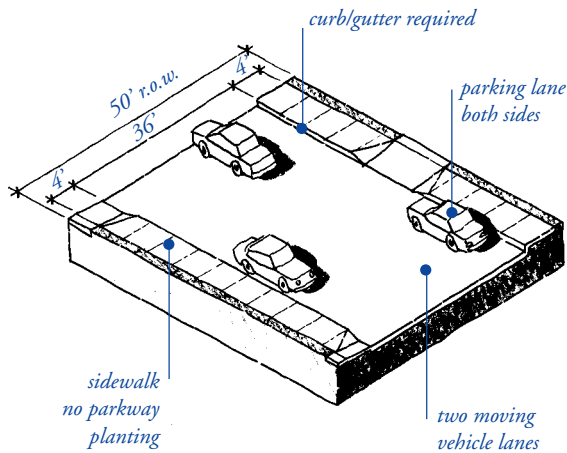

Typical current standard for a local street:

90±% impervious land coverage

Given the generally accepted rule-of-thumb for residential street design of 10 vehicle trips per day per dwelling unit, a street with ten single family homes can be expected to generate an ADT of 100, or an average of one vehicle trip approximately every 15 minutes (every 6 minutes in the peak hour). In comparison, a local street serving one hundred homes (1,000 ADT) will generate an average of one vehicle trip every 90 seconds (every 30 seconds in the peak hour). When built to typical municipal standards, the two mandated moving lanes of a local street use a great deal of land area for very little traffic. If the street is considered in terms of space, rather than lanes, a central space wide enough for one vehicle can be retained for movement, with parking and waiting space along both sides. In the infrequent instance when two vehicles approach in opposite directions, one vehicle can pull into the parking lane to allow the other vehicle to pass in the central moving space. The many driveway openings on either side of the street ensure that at any given segment of the street some space will be available for waiting, even if parking spaces are full on both sides. On lightly traveled streets, the minor inconvenience of waiting for oncoming traffic does not occur very often, making a shared central moving space feasible for streets serving up to 50 dwelling units (500 ADT, one vehicle every 3 minutes average, every 1.5 minutes peak).¹³

Impervious land coverage and street design standards.

Most Bay Area municipal street standards mandate over 80% impervious land coverage in the public right-of-way. Alternative standards can significantly reduce impervious land coverage while meeting access needs of local, residential streets.

Representative local street standards for Bay Area municipalities.

Jurisdiction	Street width	curb/gutter required	sidewalk required	parkway planting	r.o.w. imper.
Alameda Co.	40 ft.	yes	5'/side	no	100%
Concord	36	yes	4'/side	varies	90%
Contra Costa Co.	32	yes	4'/side	no	78%
Palo Alto	40	yes	4'/side	yes	85%
San Jose (std.)	35	yes	5'/side	no	100%
San Mateo Co.	36	yes	4'/side	no	94%

Alternative street standards for local and access streets.

Neotraditional	28±	no	4'±	yes	74%
Rural	20±	no	no	yes	36%
San Jose (alt.)†	30	yes	4'/side	yes	81%

(All standards reflect minor or local street standards for flat areas to accommodate two way traffic, with parking both sides, typical right-of-way between 45 and 60 feet wide.)

† San Jose Narrow Residential street standard, parking one side only.

Street design standards, continued

Unlike most municipal standards, which set street width by number of vehicle lanes and roadway classification (local, collector, arterial), street design by anticipated traffic volumes (ADT) allows for varying pavement width to match usage. Using the analogy of stream flow, this “headwaters streets” system allows the most “upstream” streets, those serving approximately 50 adjacent dwelling units, to have widths as low as 16 feet while allowing two-way traffic. As traffic volumes increase on neighborhood streets, pavement widths also increase, just as streams widen downstream to accommodate increased water volumes.¹⁴ In practice this generates a new class of street for very low traffic volumes, referred to as “access” streets, which are below “local” street in the standard street hierarchy.

For example, an access street serving 50 single family homes (25 each side) with 50 foot width lots would require 1,250 linear feet of street $[(50 \text{ sfh}/2) \times 50 \text{ ft} = 1250]$. A 36 foot wide street would cover 45,000 square feet, usually in impervious asphalt or concrete pavement. A 26 foot wide street would cover 32,500 square feet, a reduction of 12,500 of impervious land coverage. Assuming street construction costs of \$3 per square foot, this reduction in pavement generates a \$37,500 reduction in development costs, or \$750 per lot. This does not account for added cost reductions in reduced need for drainage systems because of smaller impervious land coverage. Even greater reductions in pavement can be achieved if on-street parking is not required on both sides the entire length of the street, or if sidewalks are not required on both sides.

General considerations for residential street design. Alternative standards are feasible for local residential streets that employ “neo-traditional” or “headwaters street” design. These alternative standards can reduce impervious land coverage and provide drainage systems with less impact on stormwater quality compared to current typical municipal street standards, while accommodating local traffic and emergency access.

Street designs are often controversial, and development of new street standards must meet a variety of engineering, public safety and functional criteria. Municipal agencies with a strong interest in street design, such as Public Works, Planning, and emergency service providers, often differ on priorities and approaches. Alternative standards must be developed cooperatively so that each agency’s legitimate interests are accommodated. In municipalities which have not adopted alternative standards, developers can propose these designs as part of a planned unit development zoning, subject to government approval.

Several communities in the United States have recently adopted new street standards for local access streets, including Bucks County, PA., Boulder, CO., Portland, OR, and San Jose, CA.¹⁵ These new municipal street standards vary, but they all include reduced street widths (generally between 16 and 30 feet), shared moving lanes, reduced design speeds, and an ability to omit curbs, gutters and/or sidewalks on one or both sides. New ITE neo-traditional street design standards currently in review may help formalize acceptable alternative residential street designs.¹⁶

Parking requirements

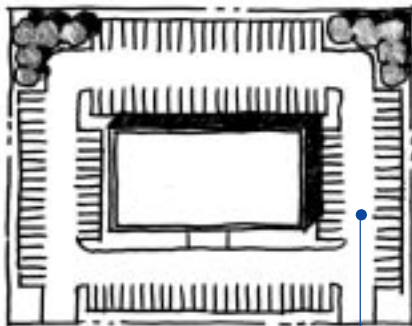

*entire site covered
with parking*

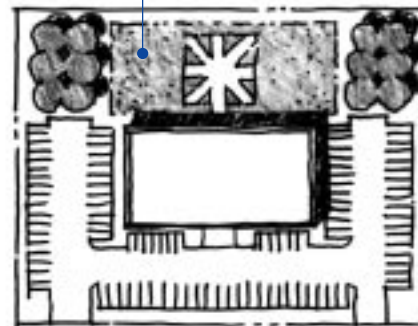

1 acre of landscape gained

Parking is the greatest single land use in most industrial, office, and commercial development. Municipal codes usually mandate a minimum amount of parking and the type of approved pavement. Adjusting these requirements can significantly mitigate the negative environmental impact of parking, while still providing adequate storage space for cars.

Amount of parking. Parking minimums have been established by planners and professional associations, such as Urban Land Institute, the Institute of Transportation Engineers, the National Parking Association, and the American Planning Association. These minimums are based on empirical methods, usually by counting cars parked at existing land uses, identifying the peak use, and then requiring developers to supply enough parking to meet the peak demand (or near peak demand). These standards typically result in a large, underutilized parking capacity.

For example, a 1995 study of office buildings in ten California cities found that peak parking demand averaged only 56% of capacity. In shopping centers, parking lot design standards supply enough parking for the demand at the “20th busiest hour” of the year. This means that for all but 19 of the 3,000 hours that a typical center is open annually there will be a parking surplus, leaving at least half of the center’s spaces vacant at least 40 percent of the time.

Because of these high minimum standards, parking and its associated transportation system usually account for the majority of land use in commercial and industrial sites. A recent survey

completed by the City of Olympia, Washington, for example, found that over half of the city’s commercial sites were devoted to parking and driveways.

Not only do these standards and their related zoning ordinances mandate high parking minimums— developers are free to build more. They usually do, if they can, because retailers and office tenants demand “plenty of parking” – they naturally want to make it easy for shoppers and tenants to reach their sites. Also, conventional asphalt parking lots are less expensive to build and maintain than turf or landscaped areas, further contributing to the tendency to build even more than the minimum standards.

Land Use Solutions. Several solutions can promote a more balanced approach to parking and land use.

a. institute paid parking. Studies show that motorists park free for 99 percent of all automobile trips. By pricing parking at its true cost, natural economics would tend to reduce demand, free more land for other uses, and encourage alternative transportation. Employer-paid parking programs, with cash incentives for employees who opt not to park, or employee-paid parking, have both proven effective at reducing parking demand in commercial and office uses.

b. reduce parking minimums. Reducing the mandated parking minimums in zoning ordinances can significantly reduce the amount of parking provided. For example, reducing the office use minimum from four to three spaces per thousand square

Parking requirements, continued

feet (1:250, 1:333) would reduce the number of required parking spaces for a 100,000 square foot office building from 400 to 300, a reduction of 25%, or approximately an acre of land that could be converted from parking to landscape that can be designed to filter and infiltrate the runoff from impervious surfaces (see 6.6). Depending on the number of building occupants and availability of alternative transportation, reduced parking minimums may be adequate for a variety of uses.

c. establish parking maximums. Some municipalities, in seeking to reduce the negative impacts of these large parking demands, have established *maximum* parking ratios instead of the more conventional parking minimums. For example, Lacey, Washington, has developed a phased program to implement maximum parking standards for its downtown. These standards will be reduced in three year intervals, giving businesses and travelers time to adjust driving patterns. Parking maximums prevent developers from building more than the maximum allowed parking, and the scarcity of parking, usually coupled with pricing strategies, naturally reduces parking demand and encourages alternative transportation.¹⁷

d. allow reduced minimum requirements as incentives. Some municipalities allow reduced minimum parking requirements as incentives for transportation demand management programs or for developments that encourage alternative transportation such as live-work, transit oriented residences, office buildings with bicycle commuter facilities, or neighborhood retail shopping areas. In these areas parking requirements can be reduced by as much as 20 to 30%, reflecting the fact that a significant proportion of people do not park at the site.

e. establish landscape reserves. Another strategy to reduce the amount of parking that allows for parking expansion if needed is to identify “landscape reserve” on site plans. These landscape reserves are areas adjacent to parking lots that are of appropriate size and geometry to accommodate additional parking. They are initially installed as landscape areas, but identified as “landscape reserve” on approved plans. If the need for parking increases beyond the amount originally provided, the landscape reserve can be converted to parking.

f. allow shared parking facilities. Shared parking facilities are another strategy to reduce overall parking supply, while still meeting demand. For example, a movie theater’s parking demand is usually evenings and weekends, while office building demand usually peaks on weekdays— these uses can share a single parking lot, owned either by the city, or by one or both of the property owners. In commercial districts, parking supply for shoppers can be maintained by allowing employees to park on nearby residential streets, since resident parking peaks in the evening while employee parking peaks during the day. There are considerable obstacles to these shared parking approaches, such as zoning regulations that do not allow combining parking for separate uses, resistance of neighborhood residents towards employee parking on their streets, and liability and insurance issues surrounding sharing of a single, privately owned parking facility by multiple property owners.

g. promote parking garages. Underground or above ground parking garages reduce land coverage by allowing parking to be stacked or combined with building area. The expense of these solutions can be mitigated by providing building credits, in-lieu parking fees, subsidies, or fee waivers.

Parking lot paving. Aside from the amount of occupied land area, the type of parking lot pavement has a direct impact on stormwater quality. Parking lots are usually built of impervious pavement, such as conventional asphalt, and their large land area makes them a significant contributor to environmental degradation. Permeable materials such as porous asphalt, crushed aggregate, open-celled unit pavers, or turf block can be suitable parking lot pavements, especially for parking stalls (as opposed to aisles— see 6.3a Hybrid parking lot), for outlying spaces that are only typically used during peak demand (see 6.3c Overflow parking), or for occasional uses such as churches or sports stadiums.

Many municipalities mandate an impermeable pavement such as conventional asphalt or concrete for parking lots and prohibit the use of other materials. Where these impermeable pavements are mandated, rewriting municipal codes to allow permeable pavement alternatives is a prerequisite for their use.¹⁸

Community education and outreach

All those involved in the development industry need to understand the impacts of development on water quality, as well as the appropriate application of various strategies. This includes not only those who design and build, but the residents, occupants, and maintenance staff.

Community education and outreach are the key to building this understanding. Furthermore, community education and outreach on stormwater impacts is a minimum requirement of the NPDES regulations.

The NPDES regulations mandate public education and outreach and public involvement/participation as *minimum* control measures.

The activities enumerated in the regulations include:

- distributing of educational materials to the community
- conducting outreach activities on the impacts of stormwater
- providing public education on how to reduce stormwater pollution
- informing individuals and households on proper maintenance of stormwater systems
- teaching how to limit the use and runoff of garden chemicals
- promoting local stream restoration through conservation corps and other citizen groups

- participating in storm drain stenciling
- targeting specific industries or groups with specific stormwater impacts (e.g. restaurants and grease impacts on storm drains)
- engaging the public in a participatory process to develop, implement and review the local stormwater management program
- impaneling a group of citizens to participate in the decision-making process, hold meetings, or work with volunteers
- reaching out to all members of a community.

This outreach effort can be directed towards members of the public and individuals, as well as to targeted groups of commercial, industrial, and institutional entities likely to have significant stormwater impacts. For example, restaurants can be targeted with specific information on the impact of grease on storm drains, and architects can be targeted with specific information on selection of building materials and design for stormwater quality management.

Finally, it is important to involve the public in the development of outreach programs, and to tailor the message to address the viewpoints and concerns of all communities, including minority groups, disadvantaged communities, and children.

SWMPs, SWPPPs, and BMPs

The current construction environment presents designers and developers with an array of mandates, regulations, and conditions for approval that relate to stormwater quality. By understanding the alphabet soup of acronyms, review agencies, and conditions it becomes easier to navigate the approval process and anticipate the design strategies that will be successful.

The National Pollution Discharge Elimination System (**NPDES**), a provision of the federal Clean Water Act, mandates that each large population center obtain a permit to discharge stormwater. BASMAA's seven participating stormwater programs, for example, serve as umbrella organizations for their co-permittee municipalities.

These NPDES permits are issued by the Regional Water Quality Control Board (**RWQCB**), a division of the State of California Environmental Protection Agency. There are nine regions throughout the state, and each Regional Board monitors each permittee for compliance.

To meet the goals of the NPDES permit, each local stormwater program, and each co-permittee within a program, establishes a Stormwater Management Plan (**SWMP**). These SWMPs give specific local requirements targeted to meet the environmental needs of each watershed, as well as reflecting the political consensus of each community. Because of the differences in each watershed's environmental context, as well as each permittee's attitude towards balancing environmental protection with economic growth, regional SWMPs may have different goals, methods, or targets.

In order to comply with the NPDES permit and requirements for a construction permit, each new development project resulting in a land disturbance of five acres or larger must prepare a Storm Water Pollution Prevention Plan (**SWPPP**). In a typical project, a SWPPP is a document consisting of narrative and a separate sheet within the construction document set, usually in the Civil Engineering or Landscape series, that outlines both a plan to control stormwater pollution during construction (temporary controls) and after construction is completed (the permanent constructed stormwater pollution prevention elements). The permanent controls are usually found on the sheet within the construction documents.

A SWPPP is a series or collection of Best Management Practices (**BMP**). The term Best Management Practice is a widely used, but somewhat inaccurate nomenclature, because the elements described as BMPs are not necessarily always best, nor are they always management practices. They can range from public education, like stenciling catch basins (which may not be as good as replacing the catch basin with an infiltration area), to site planning and design features, like a vegetated swale (which requires management but is not a management practice), to street sweeping (which actually is a management practice). In any case, the term BMP has wide currency and has been formalized in many local ordinances and codes. This document doesn't explicitly use the term BMP to describe the design alternatives presented, though each could be identified as a BMP in any particular SWPPP, depending on the requirements of the local SWMP.

The true management practices widely adopted in the past twenty years like stenciling catch basins and street sweeping, can be considered "*first wave BMPs*." These housekeeping practices have value, and deserve to be continued. But they perpetuate a conventional approach to stormwater management based on collection and conveyance.

Given development pressures and the environmental goals established by the Clean Water Act, more fundamental changes are required. Because the most economical and effective strategies arise in site planning and design, this document emphasizes ways to minimize the creation of new runoff, and to infiltrate or detain runoff in the landscape.

These "*second wave BMPs*" go beyond incremental changes to a conveyance storm drain system. They require a new way of thinking about impervious land coverage and stormwater management. They are a collection of proven methods and techniques that integrates stormwater management into planning and design, that reduces overall runoff, and manages stormwater as a resource, by starting at the source.

These "*second wave BMPs*" require a new way of thinking about impervious land coverage and stormwater management.

4 Site Design

The fundamental hydrological concepts and stormwater management concepts can be applied to site planning to generate forms that are more integrated with natural topography, that reinforce the hydrologic cycle, that are more aesthetically pleasing and that are often less expensive to build.

A few site planning principles help to locate development on the least sensitive portions of a site, and to create urban and suburban forms that accommodate land use while mitigating its impact on stormwater quality.

The application of these principles in developing a site plan will create opportunities for employment of a wide variety of simple design techniques to infiltrate significant amounts of runoff, improve aesthetics, and reduce development costs.

Site Design

4.1 Define development envelope & protected areas.

Each site possesses unique topographic and hydrological features, some of which are more suitable for development than others. By identifying the development envelope and protected areas, a site plan can be generated that minimizes both environmental impacts and construction costs.

4.2 Minimize directly connected impervious areas.

For decades planners, engineers and builders have been trained to get rid of stormwater. This is accomplished by connecting impervious areas to storm drains. Yet these “directly connected impervious areas (DCIAs)” are a principal contributor to nonpoint source pollution and flow impacts.

4.3 Maximize permeability. A parallel strategy to minimizing DCIAs is to maximize the permeability of the site. This is accomplished both by preserving open space and by using permeable pavement surfaces where feasible.

4.4 Maximize choices for mobility. By planning for alternative modes of transportation – bicycles, pedestrians, transit – reliance on automobiles can be reduced.

4.5 Use drainage as a design element. Unlike conveyance storm drain systems that hide water beneath the surface and work independently of surface topography, a drainage system for stormwater quality protection can work with natural land forms and land uses to become a major design element of a site plan.

Define development envelope and protected areas

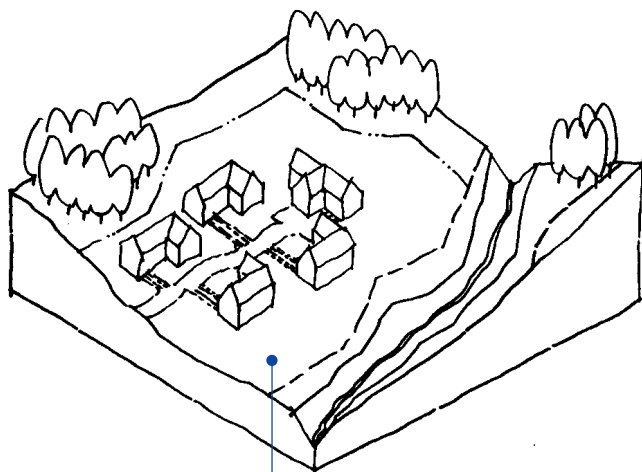

development envelope

The first step in site planning is to define the development envelope. This is done by identifying protected areas, setbacks, easements and other site features, and by consulting applicable local standards and requirements. Site features to be protected may include important existing trees, steep slopes, erosive soils, riparian areas, or wetlands.

By keeping the development envelope compact, environmental impacts can be minimized, construction costs can be reduced, and many of the site's most attractive landscape features can be retained. In some cases economics or other factors may not allow avoidance of all sensitive areas. In these cases, care can be taken to mitigate the impacts of development through site work and other landscape treatments.

Set back development from creeks, wetlands, and riparian habitats.

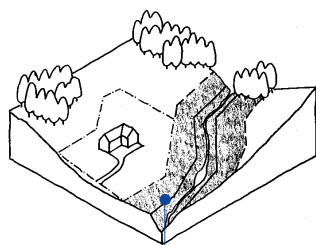

creek setback

Preserve significant trees. Trees protect soil structure, aid in soil permeability, and provide aesthetics.

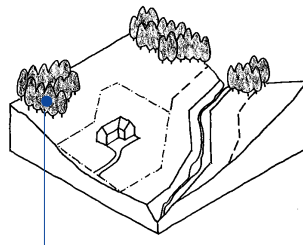

existing significant trees

Avoid erosive soils and slopes. These include steep or long continuous slopes, soils high in silt or fine sand, or soils lacking vegetative cover.

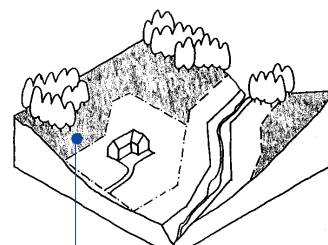

erosive soils

Minimize “directly connected impervious areas”

Directly connected impervious area (DCIA)

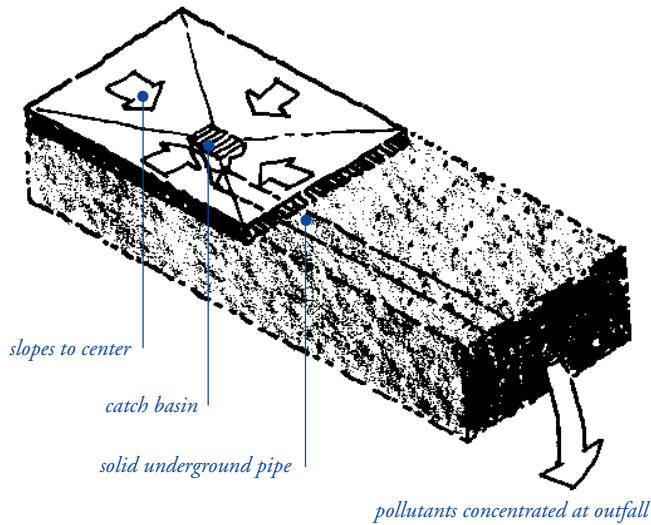

Impervious areas directly connected to the storm drain system are the greatest contributor to nonpoint source pollution. Any impervious surface which drains into a catch basin, area drain, or other conveyance structure is a “directly connected impervious area (DCIA).” As stormwater runoff flows across parking lots, roadways, and paved areas, the oils, sediments, metals, and other pollutants are collected and concentrated. If this runoff is collected by a drainage structure and carried directly along impervious gutters or in sealed underground pipes, it has no opportunity for filtering by plant material or infiltration into the soil. It also increases in speed and volume, which may cause higher peak flows downstream, and may require larger capacity storm drain systems, increasing flood and erosion potential.

A basic site planning principle for stormwater management is to minimize these directly connected impervious areas. This can be done by limiting overall impervious land coverage or directing runoff from these impervious areas to pervious areas and/or small depressions, especially the first 1/3 to 1/2 inch of rain. This means that if the site is 50% impervious, then the pervious areas must have capacity to infiltrate two times the treatment depth. In this example, that is 2/3” to 1” of rain, because both surfaces are subject to rain. Larger storms may require an underground storm drain system, but even these systems can mitigate stormwater quality impacts if runoff from impervious surfaces passes through pervious areas and depressions before being collected in conveyance devices.

Not-directly connected impervious area

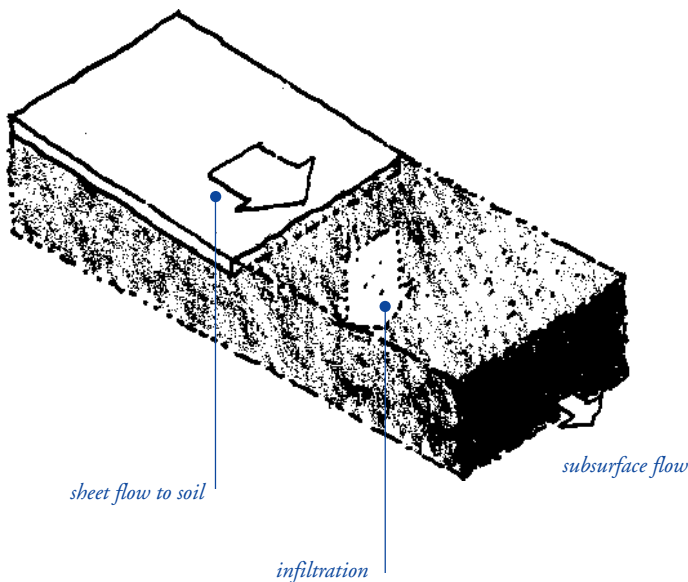

Maximize permeability

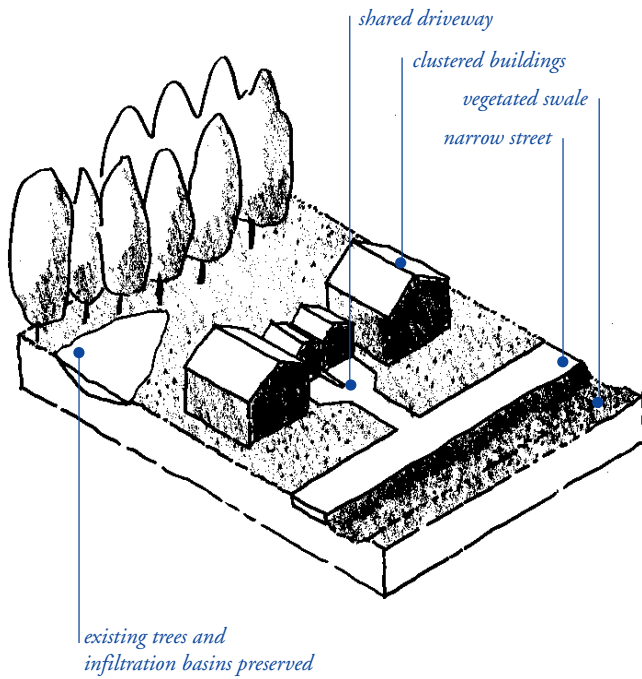

Within the development envelope, many opportunities are available to maximize the permeability of new construction. These include minimizing impervious areas, paving with permeable pavement materials, clustering buildings, and reducing the land coverage of buildings by building taller and narrower footprints. All of these strategies make more land available for infiltration and open space.

Clustered driveways, small visitor parking bays, and other strategies can also minimize the impact of transportation-related surfaces while still providing adequate access.

Once site coverage is minimized through clustering and careful planning, pavement surfaces can be selected for permeability. A patio of brick-on-sand, for example, is more permeable than a large concrete slab. Gravel, mulch, and lawns are permeable ground covers suitable for a wide variety of uses. Pervious concrete and porous asphalt, used in the eastern United States, are alternative materials that can preserve permeability where a larger, more intensely used paved area is needed.

Maximizing permeability at every possible opportunity requires the integration of many small strategies. These strategies will be reflected at all levels of a project, from site planning to materials selection. In addition to the environmental and aesthetic benefits, a high-permeability site plan may allow the reduction or elimination of expensive underground conveyance storm drain systems, yielding significant savings in development costs.

Maximize choices for mobility

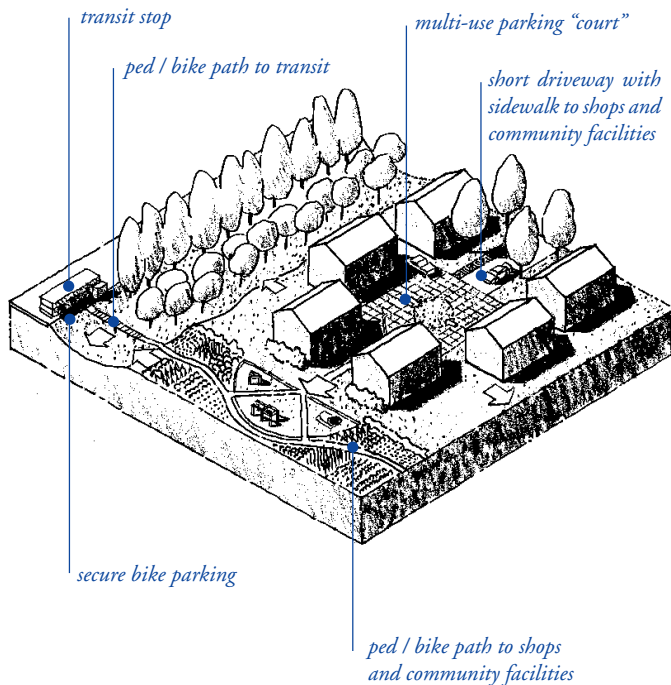

Given the costs of automobile use, both in land area consumed and pollutants generated, maximizing choices for mobility is a basic principle for environmentally responsible site planning. By designing developments to promote alternatives to automobile use, a primary source of stormwater pollution can be mitigated.

Bicycle lanes and paths, secure bicycle parking at community centers and shops, direct, safe pedestrian connections, and transit facilities are all site planning elements that maximize choices for mobility.

The automobile is a valuable, essential element of our current transportation system, and its use must be accommodated. But by giving comparable accommodation to other transportation modes, less environmentally costly choices for mobility become more viable.

Use drainage as a design element

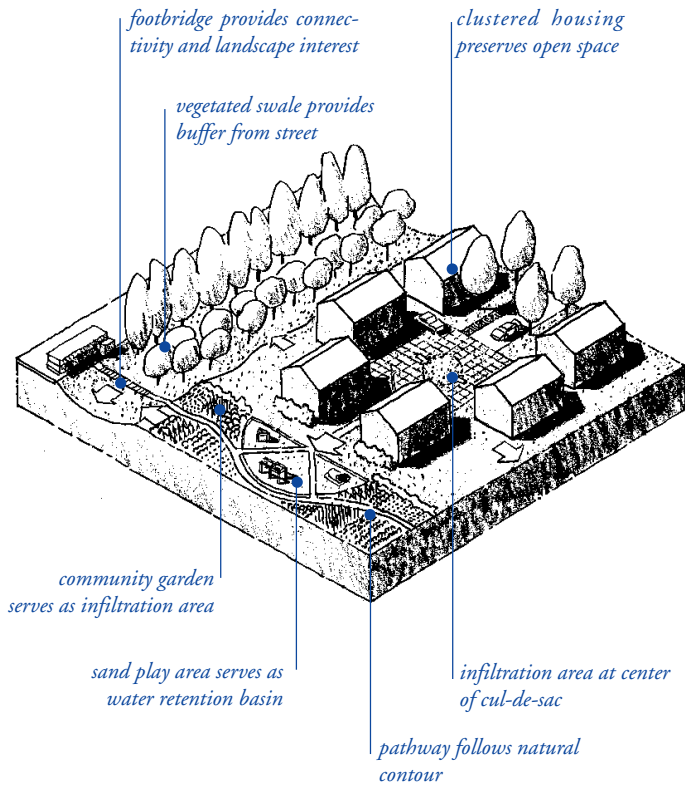

Unlike conveyance storm drain systems that hide water beneath the surface and work independently of surface topography, a drainage system for stormwater infiltration can work with natural land forms and land uses to become a major design element of a site plan.

By applying stormwater management techniques early in the site plan development, the drainage system can suggest pathway alignment, optimum locations for parks and play areas, and potential building sites. In this way, the drainage system helps to generate urban form, giving the development an integral, more aesthetically pleasing relationship to the natural features of the site. Not only does the integrated site plan complement the land, it can also save on development costs by minimizing earthwork and expensive drainage structures.



Attractive? Yes. Nuisance? Not necessarily. Because of concerns about safety and liability, many developers and municipal agencies are reluctant to combine stormwater facilities with recreational uses. Yet, a well-designed stormwater facility can be safe and attractive.

This sand play area at Village Homes in Davis, California, doubles as a stormwater detention basin. Designed to hold about six inches of rainwater, this playground has been in use for over twenty years without any reported water-related accidents, lawsuits, or injuries.¹⁹ It shows that multi-use stormwater management facilities can be both attractive and safe.

5 Drainage Systems

Conventional drainage systems are designed to achieve a single objective — flood control during large, infrequent storms. This objective is met by conveying and/or detaining peak runoff from large, infrequent storms. Drainage systems designed to meet a single flood control objective fail to address the environmental effects of increases in runoff volume and velocity caused by development, as well as flow peaks. Increased runoff from small, frequent storms erodes urban streams and washes eroded sediment and other constituents from the urban landscape into downstream receiving waters, often damaging adjoining property and impairing their use by people and wildlife.

Today's drainage systems must cost-effectively manage flooding, control streambank erosion, and protect water quality. To do this, designers must integrate conventional flood control strategies for large, infrequent storms with three basic stormwater quality control strategies for small, frequent storms:

- *infiltrate runoff into the soil,*
- *retain/detain runoff for later release,*
- *convey runoff slowly through vegetation.*

Integrated flood control/stormwater quality control designs must meet a variety of engineering, horticultural, aesthetic, functional, economic, and safety standards. This chapter briefly outlines methods and criteria for drainage system design.

Drainage Systems

5.1 Drainage system design process

5.2 Site conditions

5.3 Soils

5.4 Pollutants

5.5 Drainage system elements

5.6 System design techniques

5.7 Water quality volume

5.8 Manufactured treatment devices

Today's drainage systems must cost-effectively manage flooding, control streambank erosion, and protect water quality.

Drainage system design process

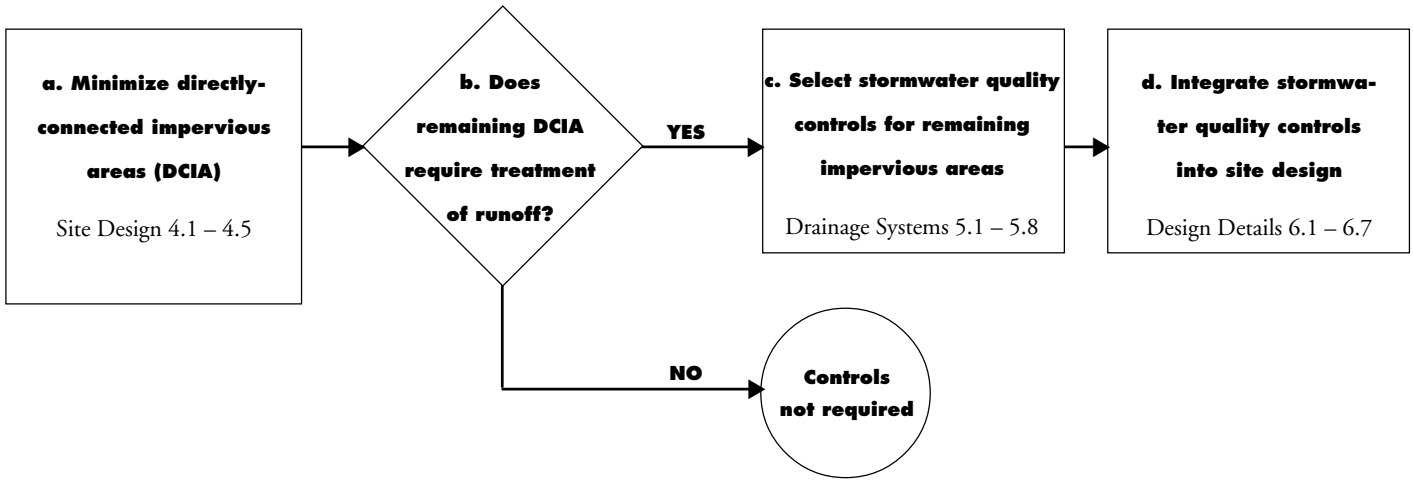

5.1 Drainage system design process. The simple design process described below establishes the foundation of a drainage system for stormwater quality.

a. Minimize directly connected impervious area (DCIA). Using the concepts and site planning strategies outlined previously, design a project to minimize directly connected impervious area.

The DCIA is measured by adding together the square footage of all impervious surfaces that flow directly into a conveyance stormwater system. These impervious surfaces are principally comprised of rooftops and conventional pavements. Impervious surfaces that are not directly connected to a conveyance system are not included in the calculation of DCIA. However, to be considered “disconnected,” intervening pervious areas receiving runoff (p) must be at least one half the size of impervious surface areas generating runoff (i). The pervious area must also be of appropriate width, location and slope, and design to effectively manage runoff.²⁰

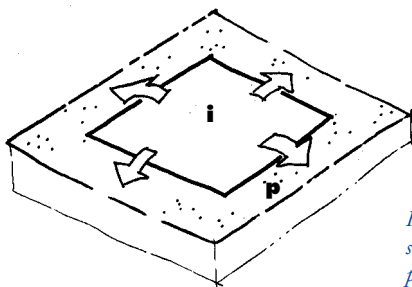

Impervious areas are considered “disconnected” if: $p \geq 1/2 i$

b. Identify DCIA requiring treatment. In some areas, a site’s DCIA coverage may not require stormwater controls if the required treatment is based on other factors (e.g. if site is located upstream from existing or regional treatment facilities, or if it is an infill development in an existing urbanized watershed). If site DCIA coverage is not treated in another manner, some form of stormwater quality control on-site is probably needed.

c. Select stormwater quality controls for remaining impervious areas. There are three stormwater quality controls appropriate for the Bay Area: infiltration, detention/retention, and biofilters. Using these approaches, alone or in combination depending on site conditions and soils, drainage systems can be designed to reduce flows and manage pollutants.

d. Integrate stormwater quality controls into site design. The Design Details section (Chapter 6) describes the many opportunities available to site designers for reducing DCIA and incorporating stormwater quality controls into site design. Local municipalities and developers can evaluate their particular opportunities and constraints to determine practical solutions within the framework presented here. Chapter 8 has more detailed information on each of these design details.

5.2 Site conditions. Site designers and municipal site plan reviewers must understand site conditions and use these as the basis for selecting appropriate stormwater quality controls.

a. Local climate. The Bay Area is distinctive for its widely varied local climates. Local climate will influence selection of controls for a specific site. For example, controls that rely upon vegetation to stabilize soils and filter pollutants may be appropriate in coastal areas with more moisture and/or moderate temperatures, while pervious pavements may be better in hotter, drier portions of the Bay region where vegetation must be more heavily irrigated.

b. “Design storm” size. Design storms used to size stormwater quality controls are significantly different than those used for conventional drainage and flood control facilities. Stormwater quality design storms generally are based on the capture of a certain fraction of the average annual runoff from the site or development. The rainfall analysis presented in the California Storm Water Best Management Practices Handbook indicates that the most “cost-effective” level of stormwater quality protection occurs when about 75 to 85 percent of the annual rainfall is captured and held long enough to allow about 80 percent of the suspended solids to settle (between 12 and 40 hours). This design storm volume ranges between 1 and 1.6 times the average storm volume of about 0.05 feet (0.6 inches) in the Bay Area.²¹ The actual design storm volume within this range depends on the drawdown time of the selected stormwater quality control.

c. Soils. Site designers must know the soils at the site when considering infiltration measures including pervious pavements. Soil conditions will determine whether a site is suitable for infiltration, or if a detention/retention system is required. See 5.3 Soils.

d. Erosion. Erosive soils impair the effectiveness of most stormwater quality controls, and must be stabilized before installing these controls. Excessive sediment clogs infiltration devices, rapidly fills detention basins, and covers vegetative measures.

e. Slope. Most stormwater quality controls are sensitive to the slope of local terrain. Biofilters and infiltration basins cannot be used in steep terrain, while detention basins usually can be made to work on any reasonably sized land parcel, as long as the area is not subject to landslides.

f. Flood control and drainage. Stormwater quality controls are sized to capture runoff from storms much smaller than those used to size drainage and flood control systems. Site developers should first consider an integrated system that achieves both stormwater quality and flood control objectives. In these integrated systems, runoff from small storms and the first portion of larger storms enters the stormwater quality control system. Flows exceeding the runoff volume of the stormwater quality control system are either bypassed into a separate drainage/flood control system or accommodated within the stormwater quality control system (as long as these larger flows do not “flush out” the pollutants captured from smaller storms).

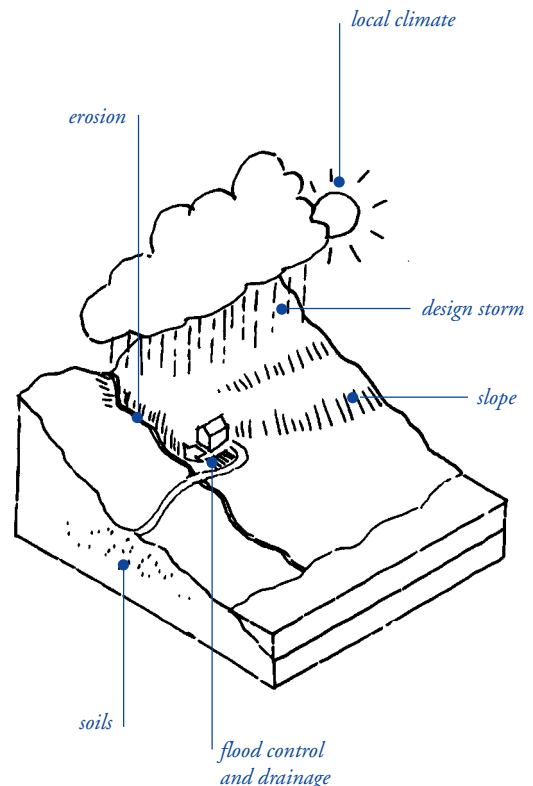

5.2 Site conditions

5.3 Soils. The USDA Natural Resources Conservation Service (NRCS) [formerly the Soil Conservation Service (SCS)], classifies a soil’s hydrologic effects into four Hydrologic Soil Groups (HSG), labeled A through D. Group A and B soils possess the greatest infiltration rates (unless soils are compacted during construction) and are generally best suited to stormwater infiltration. However, the Bay Area has a relatively high concentration of Group C and D soils, which possess lower infiltration rates that generally limit use of infiltration-based stormwater management systems.

Some soils have compound classifications, such as A/D. This indicates that the natural soil is in group D because of a high water table which impedes infiltration and transmission, but following artificial drainage using such methods as perforated

pipe underdrains, the soil’s classification is changed to A, making it more appropriate for infiltration with proper site design.

For a specific site, the HSG designation can be obtained by referring to a local soil survey, by consulting the complete national listing given in NRCS Technical Release 55, or by performing an on-site investigation. The accompanying table presents soil infiltration rates for each soil group determined by laboratory studies and measurements. Site designers should compare the design runoff volume with the available soil storage volume to determine if infiltration is feasible, and then use the infiltration rates to determine if the design runoff volume can infiltrate within a reasonable time (generally 24 to 48 hours). For sites with Group C and D soils, retention- and detention-based strategies are often more feasible than infiltration designs.

Hydrologic soil groups (HSG)²²

Group A: Low runoff potential. Soils having high infiltration rates even when thoroughly wetted and consisting chiefly of deep, well-drained sands or gravels. These soils have a high rate of water transmission.

Group B: Soils having moderate infiltration rates when thoroughly wetted and consisting chiefly of moderately deep to deep, moderately well to well drained sandy loam soils with moderately fine to moderately coarse textures. These soils have a moderate rate of water transmission.

Group C: Soils having slow infiltration rates when thoroughly wetted and consisting chiefly of silty-loam soils with a layer that impedes downward movement of water, or soils with moderately fine to fine texture. These soils have a slow rate of water transmission.

Group D: High runoff potential. Soils having very slow infiltration rates when thoroughly wetted and consisting chiefly of clay soils with a high swelling potential, soils with a permanent high water table, soils with a claypan or clay layer at or near the surface, and shallow soils over nearly impervious material. These soils have a very slow rate of water transmission.

Typical soil infiltration rates.²³

<i>Soil Type</i>	<i>Min. Infiltration Rate (inches per hour)</i>
<i>A</i>	0.30 to 0.45
<i>B</i>	0.15 to 0.30
<i>C</i>	0.05 to 0.15
<i>D</i>	0 to 0.05

5.4 Pollutants. In a natural state, water is not chemically pure. It contains sediment, minerals, and other impurities depending on the surrounding geology and climate. These impurities do not often arrive at lakes, streams, and bays (known as “receiving waters”) in concentrated form, because rainfall can infiltrate slowly into the soil, where it is cleansed by natural biologic processes. When rain falls faster than it can infiltrate, runoff flows over the surface. In most natural conditions, this runoff travels slowly through vegetation, and suspended particles settle or are filtered, sending cleaner runoff to receiving waters.

The impervious surfaces associated with urbanization prevent water from infiltrating and increase the rate of runoff. One can see rain fall on urbanized impervious surfaces – streets, rooftops, parking lots, trash and fuel handling areas, and pervious surfaces such as lawns, playfields, and exposed construction sites. Less visible are the foreign constituents that runoff carries as it flows quickly across urbanized surfaces and empties into its final receiving water. Understanding what pollutants are and where they come from can aid in designing effective stormwater treatment controls.

Constituents²⁴

Sediment. Roads, parking lots, and roofs are common sources of sediment due to wear. Unstabilized landscaped areas, stream banks, unprotected slopes and denuded dirt areas also contribute. Sediment is a main component of total suspended solids (TSS), and is detrimental to aquatic life. Sediment also transports pollutants such as trace metals, nutrients, and hydrocarbons that attach to each particle.

Organic Compounds. These compounds are derived from automotive fluids, pesticides, and fertilizers. Organic compounds often attach to soil particles. Removal of soil particles from runoff via sedimentation or filtration will likely reduce the surface water pollution potential of organic compounds as well.

Nutrients. Nutrients include nitrogen, phosphorus, and other organic compounds which can be found in organic litter, fertilizers, food waste, sewage and sediment. Excess nutrients impact creek health and impair use of water in lakes and other water supply sources by promoting excessive growth of algae or vegetation (i.e. eutrophication).

Metals. Sources of trace metals (copper, lead, cadmium, chromium, nickel, and zinc) can include motor vehicles, roofing and construction materials, and chemicals. Trace metals can be toxic to aquatic organisms and, in accumulated quantities, can contaminate drinking water supplies. Removal of sediment from runoff via sedimentation combined with surface infiltration will reduce the amount of metals that reach receiving waters.

Bacteria and viruses. Sources include animal excrement (found in areas where pets are often walked), sanitary sewer overflow, and trash handling areas (dumpsters). Bacteria and viruses may pose public health and safety concerns if they are present in drinking water reservoirs or recreational water bodies.

Oil and Grease. Sources of oil and grease include motor vehicles, food service establishments, and fueling stations. Oil and grease act as carriers for heavy metals and contain hydrocarbon compounds, which even at low concentrations may be toxic to aquatic organisms.

With proper maintenance of stormwater management systems, pollutants infiltrating into the soil do not usually pose a risk of contaminated soil or groundwater. Risk is greater when there is a concentrated source of pollutants, such as in a heavy industrial site or in the case of illegal disposal.

A case study by the USGS of a groundwater recharge basin in Fresno showed that a wide variety of urban runoff pollutants were removed by sorption within the top 1.5 inches of sediment in the basin, but no pollutants were found in the sediment at depth greater than six inches. This shows that the pollutants have not traveled more than six inches deep – well above the level of groundwater wells.²⁵

Residential developments present the least potential of contamination of groundwater or soil from infiltration systems, according to a recent study completed by the EPA.²⁶ This is because residential developments generally have low concentrations of pollutants, and the pollutants that are present have low solubility and mobility. High concentrations, when they occur, such as nitrates and pesticides or an oil spill in a driveway, are localized and small. Based on recent EPA analysis of groundwater protection and infiltration, the Santa Clara Valley Water District, for example, is currently considering revising their policy to permit infiltration basins 10 feet or less in depth.²⁷

Risk of groundwater contamination from residential infiltration systems is further minimized by findings that metals tend to remain within the upper one foot of soil depth. Organics such as petroleum hydrocarbons migrate slowly downward—allowing natural degradation to occur. Furthermore, drinking water is typically drawn from significantly greater depths. In the Santa Clara Valley, for example, wells pumped for drinking water supply are deeper than 50 feet by ordinance. In some portions of the valley, water companies pump from in the range of 400 feet, much deeper than the potential migration of most common pollutants.²⁸

Some pollutants, such as nitrates and solvents, can migrate to depths that can ultimately threaten water supply wells. Illegal dumping of waste oil, pesticides, herbicides, paint, paint thinner and other chemical products into any type of infiltration device presents additional risk to groundwater. Local water districts and other agencies generally have policies and strategies to protect groundwater supplies from these threats. These policies are an attempt to balance the environmental benefits of infiltration with the compelling need to protect soil and groundwater supplies.

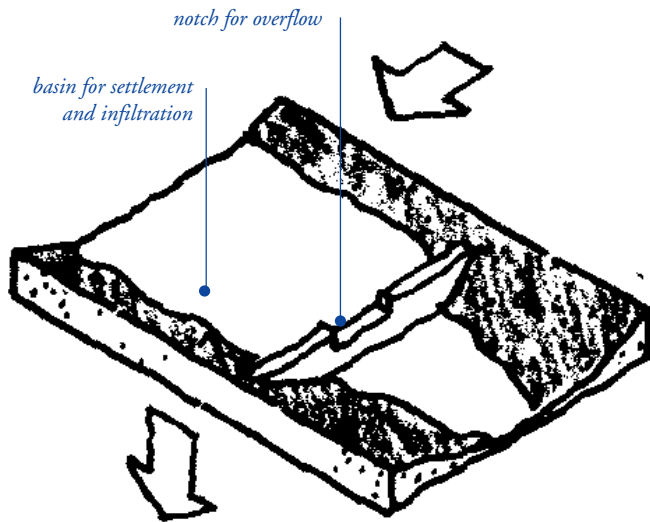

5.5a Infiltration basin

5.5 Drainage system elements. Drainage systems can achieve stormwater management goals by using one of three basic elements, either alone or in combination, depending on site and other conditions: infiltration, retention/detention, and biofilters.

5.5a Infiltration. Infiltration is the process where water enters the ground and moves downward through the unsaturated soil zone. Infiltration is ideal for management and conservation of runoff because it filters pollutants through the soil and restores natural flows to groundwater and downstream water bodies. Infiltration systems are designed to infiltrate the majority of runoff from small storms into the soil rather than discharging it into a surface water body. Infiltration basins can range from a single shallow depression in a lawn, to an integrated swale, pond, and underground storage basin network.

Site soil conditions generally determine if infiltration is feasible. In Soil Groups A and B (see 5.3) infiltration is usually acceptable, but it is severely limited in Soil Groups C and D. It is also limited where high groundwater, steep slopes, or shallow bedrock is present.

Infiltration basins can be either open or closed. Open infiltration basins, which include ponds, swales, and other landscape features, are usually vegetated – the vegetation maintains the porous soil structure and reduces erosion. Closed infiltration basins can be constructed under the land surface with open graded crushed stone, leaving the surface to be used for parking or other uses. Subsurface, closed basins are generally more difficult to maintain and more expensive than surface systems, and are used primarily where high land costs demand that the land surface be reclaimed for economic use.

Other design considerations include clogging that may occur in very fine or poorly drained soils and impacts on slope stability of hillside sites. Infiltration basins are best installed at the end of construction, after the site is fully stabilized. If installed early, bypass flows until the site is stabilized, as construction-related runoff may contain a high proportion of silts which can clog the basin floor.

Infiltration systems have been used by Caltrans and local jurisdictions in California for about three decades²⁹, though heavy Bay Area soils sometimes limit their local application. The basic

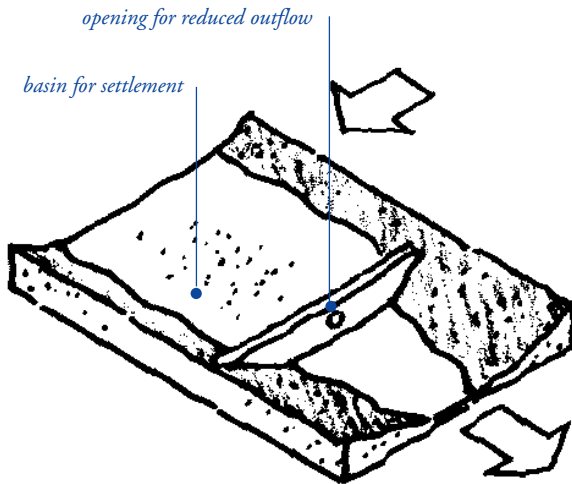

5.5b Retention/detention basin

design goal of infiltration systems is to provide opportunities for rainwater to enter the soil. This is generally accomplished by retarding the flow of runoff, and by bringing it in contact with the soil, either by holding it in ponds or moving it slowly along the ground surface. Infiltration basins are most economical if placed near the source of runoff, but they should be avoided on steep, unstable slopes or near building foundations.

5.5b Retention and detention. Retention and detention systems differ from infiltration systems primarily in intent. While infiltration systems are intended to percolate water into the soil, retention/detention systems are designed primarily to store runoff for later release. Detention systems store runoff for one to two days after a storm and are dry until the next storm. Retention systems usually have a permanent pool that retains the runoff volume until it is replaced during the following storm. Properly designed retention/detention systems release runoff slowly enough to reduce downstream peak flows to their pre-development levels, allow fine sediments to settle, and uptake dissolved nutrients in the runoff where wetland vegetation is included. Retention/detention systems are most appropriate for areas where soils percolate poorly, that is, C/D soils.

The permanent pool of a retention system and the storage volume in a detention basin are both sized equal to the runoff volume from the stormwater quality design storm, plus an additional 20 percent of this volume for sediment storage. Detention system outlets are generally sized to release 50 percent of this volume within 12 to 16 hours, and the remainder in another 24 to 32 hours.

Outlets of detention systems may clog easily if not properly designed and maintained. Retention system outlets must both maintain the permanent pool and slowly release runoff during each storm. Retention times in the permanent pool commonly are set at one to three days for removal of fine sediments, and up to two weeks for removal of dissolved nutrients through biological uptake by wetland vegetation. Common outlet designs are orifices, perforated risers, and V-notch weirs, with an emergency spillway provided to safely convey storms larger than the stormwater quality design storm.

5.5c Biofilters. Biofilters, also known as vegetated swales, are vegetated slopes and channels designed and maintained to transport shallow depths of runoff slowly over vegetation. Biofilters

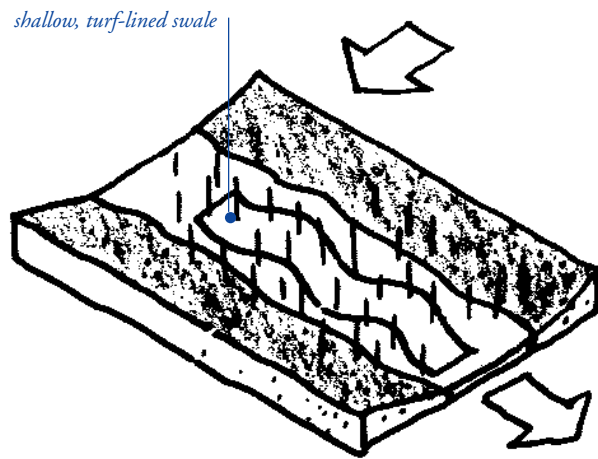

5.5c Biofilter

are effective if flows are slow and depths are shallow. This is generally achieved by grading the site and sloping pavement in a way that promotes sheet flow of runoff. For biofilter systems, features that concentrate flow, such as curb and gutter, paved inverts, and long drainage pathways across pavement, must be minimized. The slow movement of runoff through the vegetation provides an opportunity for sediments and particulates to be filtered and degraded through biological activity. In most soils, the biofilter also provides an opportunity for stormwater infiltration, which further removes pollutants and reduces runoff volumes.

Slow, shallow sheet flow is maintained in the biofilter by constructing it with gently sloping sides (3:1 slope max.), minimal longitudinal slope (1 to 2% recommended, with check dams for steeper slopes), and a flowpath length of at least 10 feet. The key concept is to move water slowly through the vegetation. The most common ground cover material is turfgrass, which must be irrigated through the dry season. For a turfgrass lined biofilter to work effectively, the turf must be mowed regularly and the cuttings removed.²⁹ Where slopes are less than 1% or where groundwater is high, wetland vegetation can be used in

biofilters. Clay soils, or soils where vegetation are inhibited, are generally not appropriate for biofilters.

Biofilters are especially applicable to parking lots, as the long aisles can be sloped into linear grass swales to collect and treat runoff from pavement surfaces. Adjacent pavement elevations should be set slightly higher than the adjacent biofilter. If water enters at concentrated points, as opposed to sheet flow, erosion control should be included at inlets and outlets.³⁰

Biofilters should be designed using the stormwater quality design storm. The peak depth of the hydrograph should be less than 3 inches and peak velocity less than 1 ft/second. Large storms should bypass the biofilter, or the biofilter should be sized to accommodate larger storms while meeting water quality criteria. The bottom width of the swale is generally 2 to 8 feet, with grass height of 4 to 6 inches and maximum water depth of less than 2 inches.

System design techniques

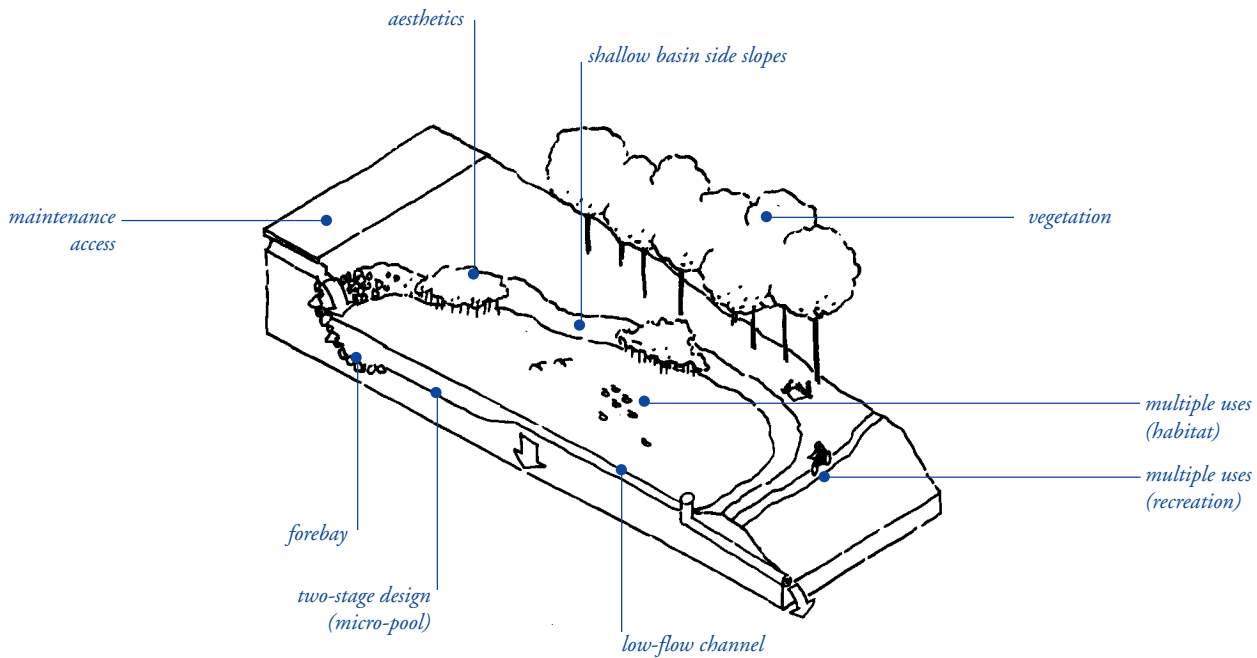

5.6 System design techniques. A variety of techniques are available to design stormwater management systems for water quality protection so that safety and aesthetics are maximized while minimizing maintenance. A key element of system design is to provide a means for managing the runoff from large storms – either a spillway or an embankment designed to withstand overtopping. The stormwater management system is usually comprised of a series of individual elements – basins, swales and pipes – in an interconnected, continuous system. Some of the techniques available to integrate these elements into the site plan and improve their functionality include:

- a. Two-stage design.** Place 15 to 25% of the volume at a lower stage to create a micro-pool that fills often, keeping the rest of the basin dry and sediment-free most of the time.
- b. Basin side slopes.** Set side slopes at 4:1 or flatter to prevent bank erosion and minimize risk of drowning.
- c. Forebay.** Design basins so that larger particles settle in depressions at basin inlets, and so inflows do not erode or resuspend materials in forebay. Plan for maintenance to remove trash, debris and sediment that collects in the forebay, as this is essential to protecting the aesthetic value of the basin and in reducing long-term maintenance costs.
- d. Low flow channel.** A low-flow channel conveys dry-weather flows and the last of captured volume to the basin outlet.
- e. Vegetation.** Plant vegetation to control erosion and enhance sediment entrapment.
- f. Maintenance access.** Access for maintenance must be included in the design of all elements. While most smaller basins and swales can be serviced by typical garden maintenance methods, larger basins may require stable vehicular access ways to forebays and outlets for periodic cleaning or dredging.
- g. Multiple uses.** Incorporate flood control, recreational facilities, landscaping, and/or wildlife habitat into system design.
- h. Aesthetics.** Integrate the basins and swales into the site to take advantage of the aesthetic qualities of water and plant materials.

Water quality volume

Stormwater systems are engineered to handle specific runoff volumes and flow rates. For flood protection, systems are designed with capacity for the expected peak runoff volumes and flow rates of a given design storm size. This is known as the “peak runoff volume.” Peak runoff volumes and flow rates are calculated for various design storm sizes, depending on local conditions, codes, and the potential damage that can be caused by flooding. Large drainage systems flood very infrequently, but they are expensive to construct. Therefore, drainage systems are typically sized to balance flooding risk and cost. Street drainage systems are typically designed for a 10-year storm, meaning that there is a 10 percent chance in any given year that a storm will be large enough to overwhelm the drainage system and flood the street. Since the flooding of a street once every ten years, on average, is a minor inconvenience, designing streets for a ten year storm represents a generally accepted balance of protection and cost. Homes and buildings suffer more severe damage from flooding, and are typically designed to remain protected in the 100 year storm, meaning that the probability of flooding is one percent in any given year.

The same need to balance costs and benefits applies to drainage system design for stormwater quality protection. Many pollutants may be carried by small, frequent storms. Because of this phenomenon, the water quality protection component of a drainage system can be designed to manage a much smaller volume and flow rate of water than the flood protection component. Also, because most rainfall occurs in small, frequent storms, water quality systems with relatively small capacities can have a large impact in minimizing overall runoff and preserving base stream flows.

This amount of water that can be managed to protect water quality is called the “water quality volume (wqv).” The water quality volume can be managed through pollution prevention, infiltration, retention/detention, and biofiltration.

The wqv is the amount of runoff from impervious areas that must be managed before being released into the conveyance storm drain network or receiving water. As with flood control volumes, there are a variety of approaches and standards for

defining the water quality volume:

- as a proportion of total annual runoff from impervious surfaces
- as a depth of rainfall
- as the runoff from impervious surfaces of a storm with a particular recurrence interval.

Note that the water quality volume applies only to impervious areas. It is not generally necessary to treat runoff from pervious areas. For this purpose, pervious areas are defined as those areas with a coefficient of runoff of 0.30 or less, meaning that 70% or more of the rainfall landing on a given surface infiltrates into the soil.

Because BASMAA is an association of several stormwater programs representing dozens of municipalities, each with different circumstances, this document does not establish specific hydrologic criteria or a specific water quality volume.

As with flood control, there are a variety of standards and approaches for quantifying how to manage stormwater for water quality protection. The California Storm Water Quality Task Force, in its *Storm Water Best Management Practice Handbooks* (1993), and the Water Environment Federation/American Society of Civil Engineers in their jointly published *Urban Runoff Quality Management* (1998) each adopted an 80% annual capture rate as a standard of practice for the water quality volume. In the San Francisco Bay Area, this translates into approximately the first 0.50-1.25 inches of rain, or a two-year recurrence interval storm.

The Center for Watershed Protection in Silver Spring, Maryland, a leading independent research center, recommends a 90% annual capture rate. Some jurisdictions, such as the City of Olympia (WA) and the Washington State Department of Ecology, have focused on reducing impervious land coverage, adopting impervious surface reduction targets rather than emphasizing a specific water quality volume.

Manufactured treatment systems

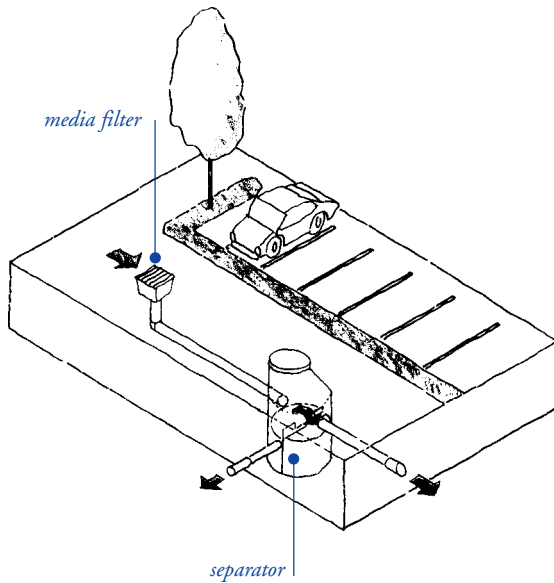

Some areas are so densely developed that streets, buildings and walkways provide almost complete impervious land coverage. Here, land values prohibit the use of landscape solutions such as biofilters, infiltration basins, or wet ponds. In addition, the soil conditions in these highly urbanized locations often do not support infiltration, further reducing the practicality of landscape stormwater quality systems.

In these areas, if treatment is required, manufactured treatment systems can be inserted into a conventional conveyance storm drain system. In some cases, these devices can supplement more integrative site planning and landscape strategies.

These devices are available from many manufacturers, and generally function to separate urban pollutants from runoff. They have minimal impact on reducing overall runoff volumes or mitigating peak flows. Other considerations include both initial expense and the cost of intensive, regular maintenance recommended by device manufacturers, which can include trash removal, replacement of filters, flushing cartridges, and vacuuming of sediment.

Though promoted by their manufacturers, these devices are considered experimental by the scientific community, and their efficacy is still under study. Though many proprietary designs

are available, general product categories are presented here.

Catch basin or inlet inserts. Also referred to as inlet filters, catch basin inserts are trays or baskets containing filter and/or oil-absorbent materials installed on the inside of storm drain inlets to filter and capture pollutants. They work through filtration, settling, and absorption.

Separators. These devices (also called oil/grit or oil/water separators, water quality inlets, interceptors) are structures designed to remove pollutants from a wastewater stream based on physical differences between the pollutant and water. Lighter materials such as oil and buoyant trash will float to the surface and heavier materials such as sediments will sink.

Media filters. These devices use media to filter pollutants from urban runoff. Media includes sand, gravel, peat, compost, activated carbon, fabric, and resin.

In a watershed plan that employs clustered, dense development to preserve open space, on-site treatment in the more densely developed portion of the watershed may not be necessary. Dense or clustered development allows for significant areas to be preserved and remain undeveloped, reducing the need to mitigate throughout the entire watershed.

6 Site Design and Landscape Details

Once a site plan is generated, a multitude of small design decisions must be made, each of which will affect the hydrology of a development. These design decisions include selection of paving materials, collection of roof runoff, grading of landscaped areas, and many other details.

Any particular detail may make little difference in the overall impact of a development, but taken together, these details exert a profound influence on the ability of a development to meet stormwater quality goals. Consistent with the concept of starting at the source, these details look for opportunities to manage small quantities of runoff at many diverse locations throughout a site.

A variety of design techniques and details are presented in this chapter. Each illustrates an approach to design and construction for maximizing infiltration, providing retention, slowing runoff, and minimizing impervious land coverage. The techniques presented here are not all-inclusive, and may not be appropriate for every site or condition, but it is hoped that, once the intent of these details is understood, designers and builders will use their ingenuity to develop additional strategies consistent with water quality goals.

Site Design and Landscape Details

6.1 Permeable pavements

6.2 Streets

6.3 Parking lots

6.4 Driveways

6.5 Buildings

6.6 Landscape

6.7 Outdoor work areas

**Look for opportunities
throughout the site.**

- For more information about these design details, see Chapter 8.

Design Details Matrix

This matrix summarizes the details described on the following pages by their initial construction cost, maintenance cost, relative effectiveness at meeting stormwater quality goals, and their suitability for use in expansive, clay soils. Conventional approaches are also evaluated for comparison.

	Least	Most		
Legend	○	◐	●	●
			Cost (initial)	Cost (maint.)
			Effectiveness	OK in clay†
6.1 Permeable pavements				
<i>Conventional asphalt/concrete</i>	◐	○	○	●
6.1a Pervious concrete	●	●	●	○
6.1b Porous asphalt	●	●	●	○
6.1c Turf block	◐	●	●	◐
6.1d Brick	●	◐	◐	◐
6.1e Natural stone	●	◐	◐	◐
6.1f Concrete unit pavers	●	◐	◐	◐
6.1g Crushed aggregate	○	◐	●	●
6.1h Cobbles	○	◐	◐	●
6.2 Streets				
<i>Conventional street standards</i>	●	○	○	●
6.2a Access street: urban neo-traditional standard	○	○	●	●
6.2b Access street: rural standard	○	◐	●	●
6.2c Urban curb/swale system	◐	◐	●	◐
6.2d Rural swale system	○	◐	●	◐
6.2e Dual drainage system	●	●	●	●
6.2f Concave median	○	○	●	◐
6.2g Cul-de-sac	○	○	●	◐
6.3 Parking lots				
6.3a Hybrid parking lot	○	◐	●	●
6.3b Parking grove	◐	○	●	●
6.3c Overflow parking	○	◐	●	●
6.3d Porous pavement re-charge bed	●	●	●	●
6.4 Driveways				
<i>Conventional driveway</i>	○	◐	○	●
6.4a Not directly-connected impervious driveway	○	○	●	◐
6.4b Crushed aggregate	○	◐	●	●
6.4c Unit pavers on sand	●	◐	◐	◐
6.4d Paving only under wheels	○	◐	●	●
6.4e Flared driveways	○	○	●	●
6.4f Temporary parking	○	◐	●	●
6.5 Buildings				
<i>Conventional pipe system</i>	●	◐	○	●
6.5a Dry-well	○	◐	●	◐
6.5b Cistern	●	◐	◐	●
6.5c Foundation planting	○	○	●	◐
6.5d Pop-up emitters	○	◐	●	○
6.5e Building materials	◐	◐	●	●
6.6 Landscape				
<i>Conventional pipe system</i>	●	◐	○	●
6.6a Grass/vegetated swales	○	◐	●	●
6.6b Extended detention (dry) ponds	○	◐	●	●
6.6c Wet ponds	○	●	●	●
6.6d Plant species selection for infiltration areas	○	◐	●	●
6.6e Landscape maintenance for stormwater systems	◐	◐	●	●

† Details are indicated suitable for clay if they either reduce DCIA or can be designed as retention/detention systems.

• For more information about these design details, see Chapter 8.

Permeable pavements

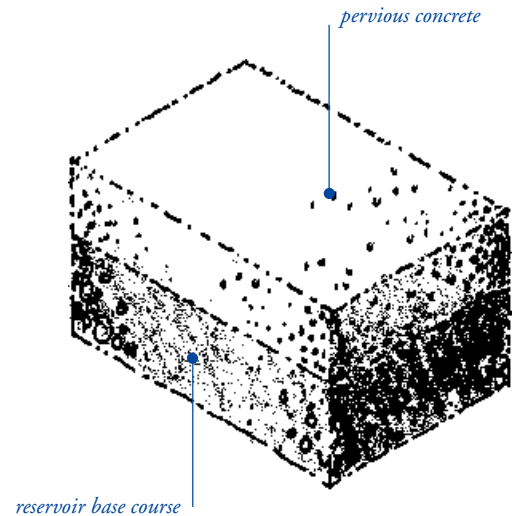

6.1a Pervious concrete

6.1 Permeable pavements. Permeable pavements are a method of infiltrating stormwater while simultaneously providing a stable load-bearing surface. While forming a surface suitable for walking and driving, permeable pavements also contain sufficient void space to infiltrate runoff into the underlying reservoir base course and soil. In this way they can dramatically reduce impervious surface coverage without sacrificing intensity of use.

There are three main categories of permeable pavements: poured-in-place pervious concrete and porous asphalt, unit pavers-on-sand, and granular materials.

All of these permeable pavements (except turf block) have in common a reservoir base course. This base course provides a stable load-bearing surface as well as an underground reservoir for water storage. The base course must meet two critical requirements:

- it must be *open graded*, meaning that the particles are of a limited size range, so that small particles do not choke the voids between large particles. Open-graded crushed stone of all sizes has a 38 to 40% void space, allowing for substantial subsurface water storage.³¹
- it must be *crushed stone*, not rounded river gravel. Rounded river gravel will rotate under pressure, causing the surface

structure to deform. The angular sides of a crushed stone base will form an interlocking matrix, allowing the surface to remain stable.

Depending on the use of the surface, a permeable, engineered base section may need to be added to support the intended load. This applies to areas subject to heavy vehicle loads, but is also important for large areas where settling could result in unwanted puddles in areas such as pedestrian walkways.

Pervious concrete and porous asphalt are two emerging paving materials with similar properties. Like their impervious, conventional counterparts, both make a continuous, smooth paving surface. They differ from their conventional counterparts in that they allow water to pass through the surface course to the rock base course that serves as a reservoir and infiltration basin for stormwater. Both pervious concrete and porous asphalt share similar design considerations.

6.1a Pervious concrete. Pervious concrete, also known as Portland cement pervious pavement, is most commonly used in Florida, where it was developed in the 1970s. Pervious concrete is a discontinuous mixture of coarse aggregate, hydraulic cement and other cementitious materials, admixtures, and water, which forms a permeable pavement.

Permeable pavements, continued

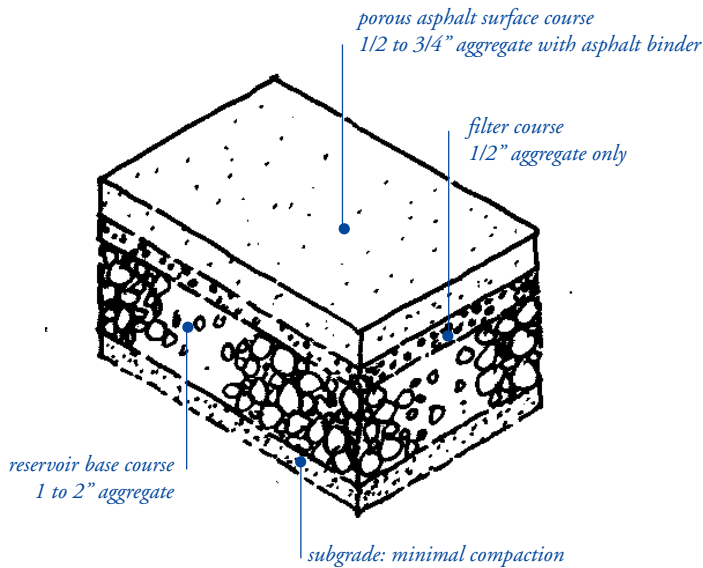

6.1b Porous asphalt

(adapted from City of Rockville, MD. specifications)

Pervious concrete, like other concretes, acts as a rigid slab. It has an appearance very similar to exposed aggregate concrete, and provides a similar walking or riding surface. An aggregate base course can be added to increase total pavement thickness or hydraulic storage. Pervious concrete is an extremely permeable material: in tests by the Florida Concrete and Products Association, permeability of new surfaces has been measured as high as 56 inches per hour. With improper installation or mix, permeability can be reduced to 12 inches per hour. Even after attempts to clog the surface with soil by pressure washing, the material retained some permeability.³² Because of its porosity, pervious concrete pavements usually do not require curbs and gutters for primary drainage control.

6.1b Porous asphalt. Porous asphalt consists of an open-graded asphalt concrete over an open-graded aggregate base, over a draining soil. Unlike traditional asphalt concretes, porous asphalt contains very little fine aggregate (dust or sand), and is comprised almost entirely of stone aggregate and asphalt binder, giving it the common name “popcorn mix.” Without fines filling the voids between larger particles, porous asphalt has a void content of 12-20%, making it very permeable.

Porous asphalt is used by Caltrans as a wearing course on freeways because its porosity creates a superior driving surface in rainy weather. These installations are always over an impermeable asphalt layer and are not permeable pavements.³³

In installations where porous asphalt has been used over a permeable base, the pavement becomes an infiltration system, allowing water to pass through the surface and collect in the open-graded aggregate base, achieving stormwater management without curb or gutter systems. In these sites, mostly parking lots and light duty roads in the eastern United States, permeability has been maintained over long periods without special maintenance. The oldest porous asphalt pavement in the United States, at the University of Delaware Visitors’ Center, was built in 1973, and is still permeable and structurally sound after 23 years.³⁴

On light duty streets built of porous asphalt, some loss of porosity occurs in localized areas due to sedimentation or scuffing at intersections due to repeated wheel turning, but the overall performance of the pavement is not significantly compromised.³⁵

Pervious concrete and porous asphalt design considerations: Sealing and clogging of the pavement surface is possible, even with maintenance and high power vacuuming. Most successful installations are in Florida and other coastal areas where slopes are

flat, soils sandy, and winter sanding/salting minimal. Avoid installation in high traffic areas, and stabilize surrounding land to minimize sediment deposition on the pavement.

Installation must meet special requirements. Subgrade uniformity is essential, and slopes over a few percent are not recommended because of potential subgrade erosion. A permeable base and an infiltration rate of at least 0.5 inches/hour in the native soil is required (i.e. a HSG A or B soil).

Installation of pervious concrete and porous asphalt requires special tools and has narrower tolerances than traditional concretes or asphalts. Finally, lack of independent testing (especially in the case of pervious concrete) limits the ability to make judgements about long-term performance.

Unit costs of these permeable pavements are greater than traditional concrete and asphalt, though this cost can be offset by not building a curb and gutter drainage system. Potentially a valuable means of reducing impervious land coverage in areas requiring a large, smooth pavement, their relative unfamiliarity, special requirements and lack of conclusive testing have made pervious concrete and porous asphalt little used in the San Francisco Bay Area to date. If these materials begin to gain wider local acceptance, their relative costs will likely go down.

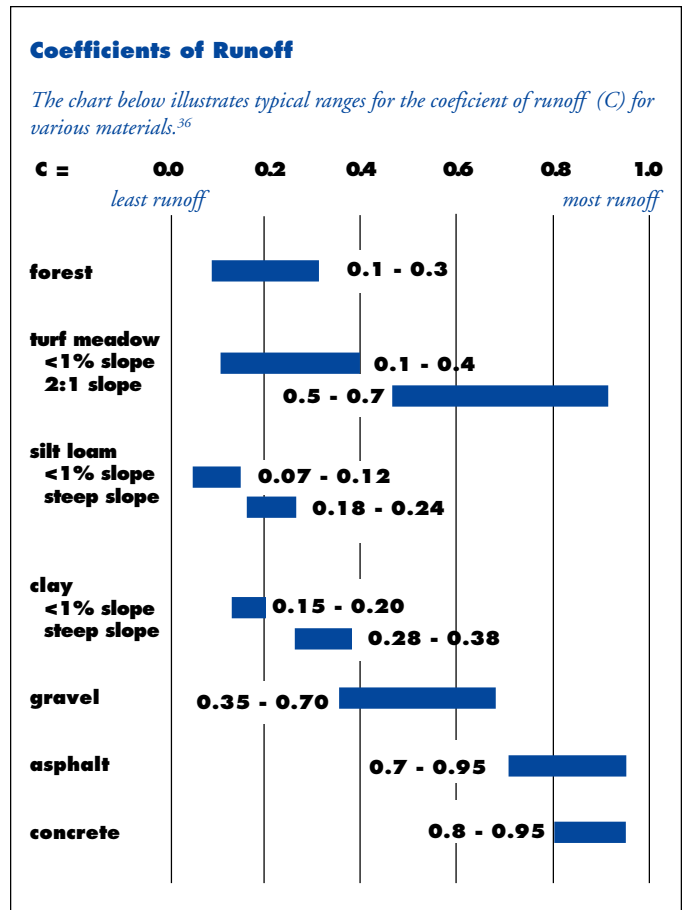

Permeable pavements, continued

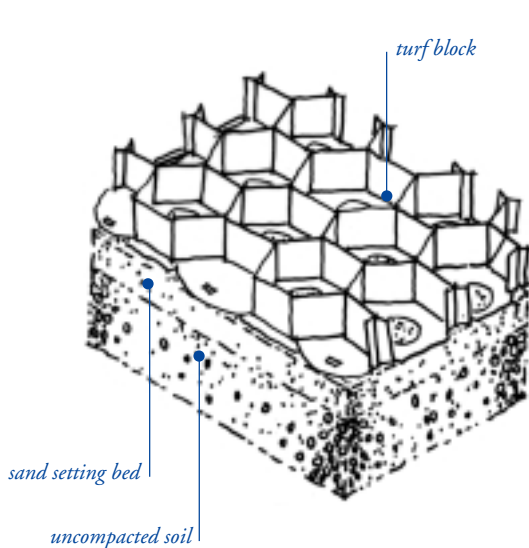

6.1c Turf block

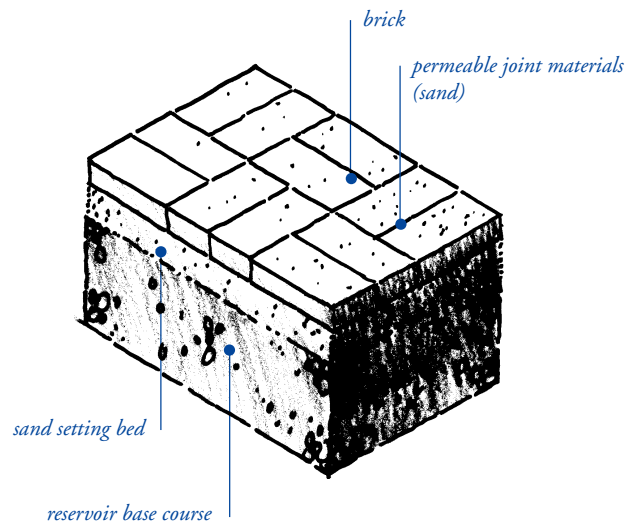

6.1d Brick

Unit pavers-on-sand. A wide variety of unit pavers are available for use in outdoor applications. Unlike poured-in-place concretes or asphalts, which create one continuous surface, unit pavers are discrete units that are set in a pattern on a prepared base. This gives unit pavers great flexibility in design, construction, and maintenance. *Open-celled unit pavers* are designed to create a permeable pavement surface, allowing water to pass through precast voids. *Solid unit pavers*, made of impermeable materials, can produce permeable pavement surfaces if they are spaced to expose a permeable joint and set on a permeable base. Unit pavers are available in many colors, shapes, and textures. Sometimes colored concrete is stamped to appear like unit pavers, but this pavement surface performs both hydrologically and structurally like a poured concrete slab, and does not provide the stormwater infiltration opportunities of unit pavers-on-sand.

6.1c Turf block. Turf block is one example of an open celled unit paver. These open celled unit pavers are available in both precast concrete or plastic, and are filled with soil and planted with turf. They were developed in Germany in the 1960s to reduce the “heat island” effect of large parking areas and are now used throughout the world. The products vary in size, weight, surface characteristics, strength, durability, interlocking capabilities, proportion of open area per grid, runoff characteristics, and cost. Laboratory tests have shown that open celled

units have runoff coefficients of from 0.05 to 0.35, depending on slope, and surface configuration.³⁷

When planted with turf, they are generally most successful in overflow parking areas, driveways, or emergency access roads. If installed in heavily used parking areas the turf often does not get adequate sunlight, and on heavily traveled roadways it can be worn away from tire abrasion. Occasionally open celled unit pavers are filled with alternatives to turf, either an inert gravel or a lower maintenance groundcover such as chamomile, that can absorb some traffic. Because of their irregular surface, open celled unit pavers generally do not provide comfortable walking surfaces, though the degree of comfort varies depending on design.

6.1d Brick. Clay fired brick is an ancient, solid paving material of great durability and flexibility. When laid on a permeable base with sand joints, brick paving provides an opportunity for a limited amount of stormwater infiltration, especially at low rainfall intensities. One experiment found coefficient of runoff volume to rainfall volume between 0.13 and 0.51 at half hour rainfall intensities up to 0.03 inches, increasing to between 0.66 and 0.76 at intensities between 0.06 and 0.12 inches per half hour.³⁸ The larger the joints, the greater the permeability.

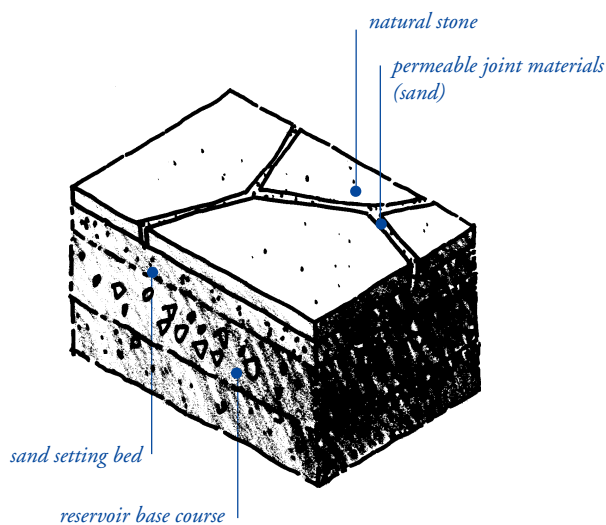

6.1e Natural stone

Brick is available in a wide range of colors and finishes, and can be set in a variety of patterns. When laid on sand, it creates a very suitable walking or riding surface. Though it was widely used for roads in the early part of this century, it is today generally used for driveways, pathways, plazas, and patios.

Because brick is a relatively soft material, brick pavements can develop a rich character over time as the surface becomes slightly worn with use and the natural colors and textures are exposed. Brick is generally comparable in cost with other solid unit pavers, though shipping costs and special finishes or colors can affect price significantly.

6.1e Natural stone. Natural stone paving materials are available in a wide variety of shapes and colors. Because of their high cost and relative brittleness, they are usually laid in thin pieces on a mortar bed over concrete, making an impervious pavement. Some natural stone materials, such as flagstone and granite, are available in thicker slabs suitable for laying on sand. When laid in a random pattern with wide sand, gravel, or soil joints (from 1/2 to 4 inches) random cut stone can create a highly permeable pavement. The joints can be planted with small groundcovers or left bare. Smaller, square cut stones can also be made into permeable pavements. The cobblestone walks of older European cities are a familiar example of natural stone pave-

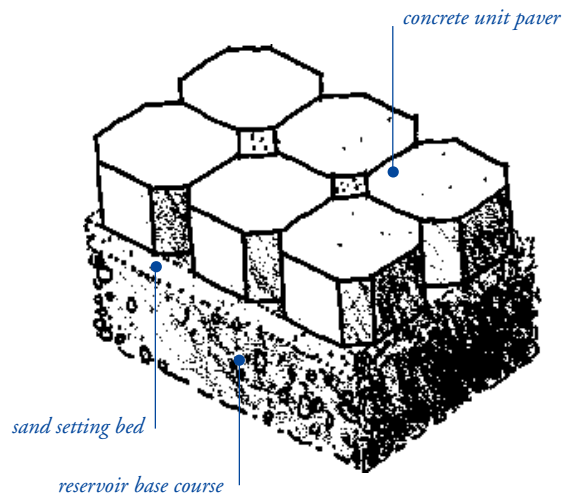

6.1f Concrete unit pavers

ment. Stones set in these tighter sand joints can be expected to have a permeability similar to brick-on-sand.

Because of their high cost natural stone pavements are generally limited to patio areas or walkways, where they can be attractive accents. Some stone materials, such as flagstone and slate, are relatively brittle and suitable for pedestrian areas only. Paving made of harder stone, such as granite, can bear vehicular loads.

6.1f Concrete unit pavers. Solid precast concrete unit pavers are available in a wide variety of colors, shapes, sizes, and textures. They are designed to be set on sand, and form an interlocking pavement surface that can bear heavy traffic loads. Their permeability and performance is similar to brick-on-sand. Some manufacturers are now producing concrete unit pavers with small voids to increase permeability (e.g. “Ecostone”). The cost of concrete unit pavers is generally the lowest of all unit pavers, though it can vary depending on shipping, special colors or finishes.

Unit pavers-on-sand considerations. Installation costs for unit pavers on sand are higher than traditional asphalt or concrete paving. Unit pavers-on-sand, however, are generally less expensive to install than mortar-set unit pavers on a rigid concrete base, especially considering the added cost of drainage struc-

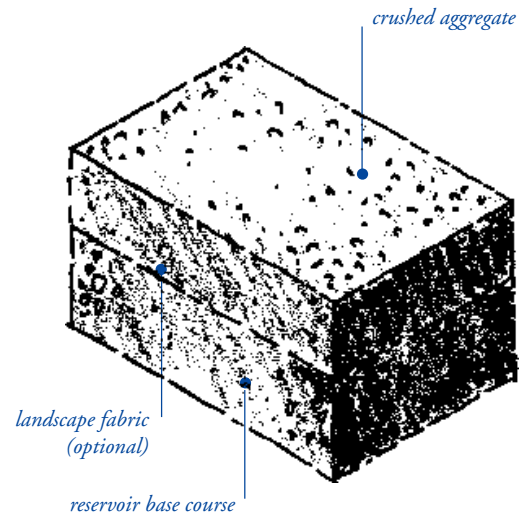
Permeable pavements, continued**6.1 g Crushed aggregate**

tures required for the mortared design. Solid unit pavers require no special maintenance, though the joints between units may require occasional weed suppression, depending on the size of the joints, the subgrade, and other conditions. Grassed open-celled unit pavers require the same maintenance as lawns. Open-celled pavers filled with gravel require periodic “topping off” of the voids to replace gravel picked up by tire tread and pedestrians.

Unit pavers are especially valuable for walkable surfaces around trees, as they allow infiltration of water and air. If root growth causes the pavement surface to become uneven, the unit pavers can be removed and reset smoothly. Differential settlement can occur in a pavement made of unit pavers on sand, creating tripping hazard. This most often occurs if the base is improperly prepared, but can be remedied by recompacting the base and relaying the pavers. Penetration of mineral and organic particles into narrow sand joints of solid unit pavers-on-sand can severely limit permeability over time.

Granular materials. A wide variety of loose aggregates can be made to form permeable pavements suitable for walking, jogging, biking, or light vehicular traffic. The size of these granular materials ranges from fine aggregates to large stones, and can be divided into two general categories: gravels and cobbles. De-

pending on the aggregate size, these granular pavements have a runoff coefficient of 0.20 to 0.40.³⁹

6.1 g Crushed aggregate (gravel). A variety of crushed aggregates, generally known as gravel, can be used to form a permeable pavement. Aggregates are available in many sizes, ranging from approximately 2” to sand sized grains known as “fines.” Relatively inexpensive to purchase and easy to install, gravel can be laid in any shape or configuration. To keep aggregates confined to its desired area, it is laid in a field that is bounded by some rigid frame such as wood header, metal edging or concrete band. Many colors, grades, and types of parent material are available, including crushed decomposed granite, base rock, and pea gravel. In selecting gravel pavements for pedestrian or vehicular traffic, crushed stones provide the most suitable surface, as the angled facets of the aggregate form an interlocking, semi-rigid matrix. Naturally worn small stones, such as pea gravel, have smooth round surfaces which rotate under pressure, making for a less firm footing. For surfaces subject to vehicular use, crushed gravel sizes between 3/8” and 3/4” make a stable surface that is also easy to walk on.

Found in a variety of settings ranging from Parisian cafes to Japanese ceremonial gardens to rural roadways, crushed aggregate

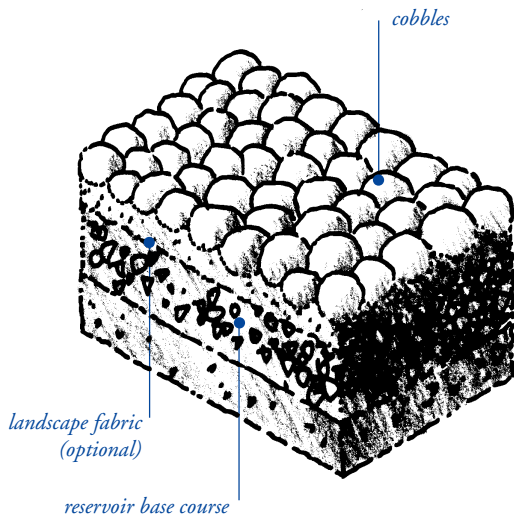

6.1 h Cobbles

gate is a versatile, economical permeable pavement material with a long history of use.

6.1 h Cobbles. Larger granular materials are known as cobbles. Cobble sizes generally range from approximately 6” to 24” diameter and are available in a variety of stones and colors. Cobbles do not make a suitable surface for walking or vehicular traffic, but are useful as a permeable pavement in areas where little traffic is desired, such as under large trees, or in hard to maintain areas such as median islands. Cobbles have similar construction characteristics as gravel, except they are somewhat more labor intensive to install because each cobble must generally be set individually.

6.1 i Wood mulch. Wood mulches and wood chips are among organic granular materials that can be used as permeable surfaces suitable for light pedestrian use. Some of these mulches meet federal requirements for playground fall surfaces, and can be inexpensive, permeable pavements for outdoor play areas.

Granular materials considerations. If laid on a slope, and subjected to moderate traffic or concentrated runoff, loose gravel can be displaced and require periodic regrading. Organic materials such as bark or wood chips decompose over time and must be replenished. Weed abatement may be required periodically,

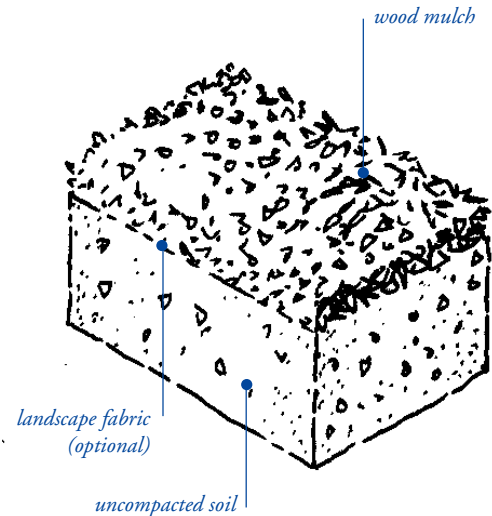

6.1 i Wood mulch

though this can be minimized by laying permeable landscape fabric between the gravel and subgrade. Installation costs for gravel and other granular materials are generally the least of all permeable pavements, but require a degree of periodic maintenance to preserve the integrity of the pavement surface.

Concrete and asphalt. Conventional concrete and asphalt (technically known as **portland cement concrete** and **asphaltic concrete**, respectively) are impervious pavements widely used in site development. Because of their ease of installation, flexibility, durability, economy, and load bearing capabilities, concrete and asphalt are the most commonly used pavement materials. With a runoff coefficient of near 1.0, conventional concrete and asphalt pavements are principal contributors to impervious land coverage in most development.

In site design for stormwater quality, these materials are best used sparingly. If more permeable pavement materials cannot be used, minimizing the area of concrete and asphalt surfaces through clustering and other techniques will reduce the resulting impervious land coverage. For remaining area, designing asphalt and concrete pavement surfaces to slope towards infiltration basins instead of into directly-connected collection structures will minimize their negative impact on water resources.

Streets

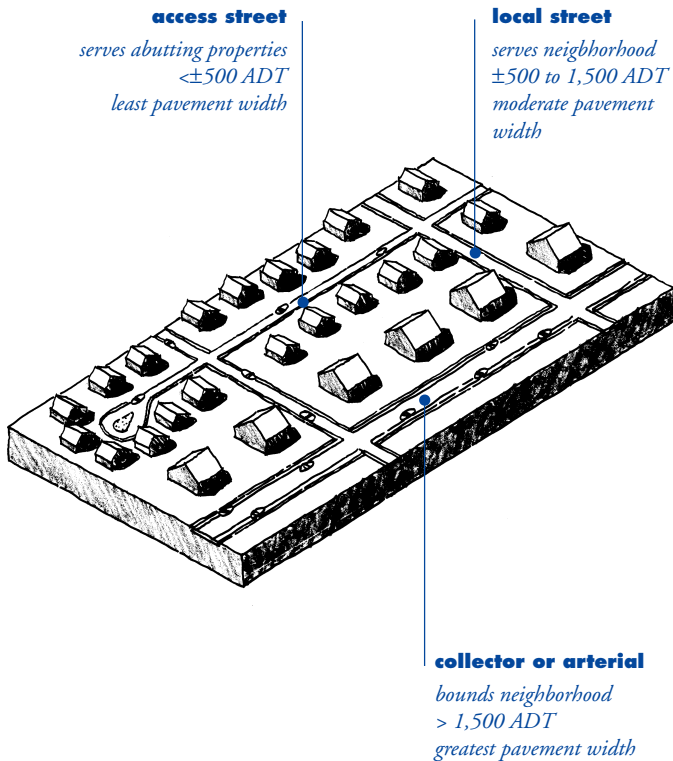

More than any other single element, street design has a powerful impact on stormwater quality. Streets and other transport-related structures typically can comprise between 60 and 70% of the total impervious area, and, unlike rooftops, streets are almost always directly connected to an underground stormwater system.⁴⁰

The combination of large, directly connected impervious areas, together with the pollutants generated by automobiles, makes the street network a principal contributor to nonpoint source pollution. Locally, the Santa Clara Valley Urban Runoff Program estimated that automobiles were the source of half or more of the copper, cadmium and zinc in its waterways.⁴¹

Street design is usually mandated by local municipal standards. These standards have been developed since World War II to facilitate efficient automobile traffic and maximize parking. Most require large impervious land coverage, with a typical Bay Area local street standard mandating that 85% or more of the public right-of-way be covered with impervious pavement.

In recent years new street standards have been gaining acceptance that meet the access requirements of local residential streets while reducing impervious land coverage. These standards generally create a new class of street that is smaller than the current local street standard, called an “access” street. An access street is at the lowest end of the street hierarchy and is intended only to provide access to a limited number of residences.

Two approaches in particular have been implemented with success in various American communities: “neo-traditional design” and “headwaters streets.”⁴² Neo-traditional design seeks to emulate the tree-lined, compact streets found in pre-war, traditional residential neighborhoods. The headwaters streets concept suggests that streets be scaled to traffic volume just as stream size increases with water volume. Both strategies allot street space according to anticipated traffic levels rather than mandating a predetermined number of vehicle lanes.

Recognizing that street design is the greatest factor in a development’s impact on stormwater quality, it is important that designers, municipalities and developers employ street standards that reduce impervious land coverage.

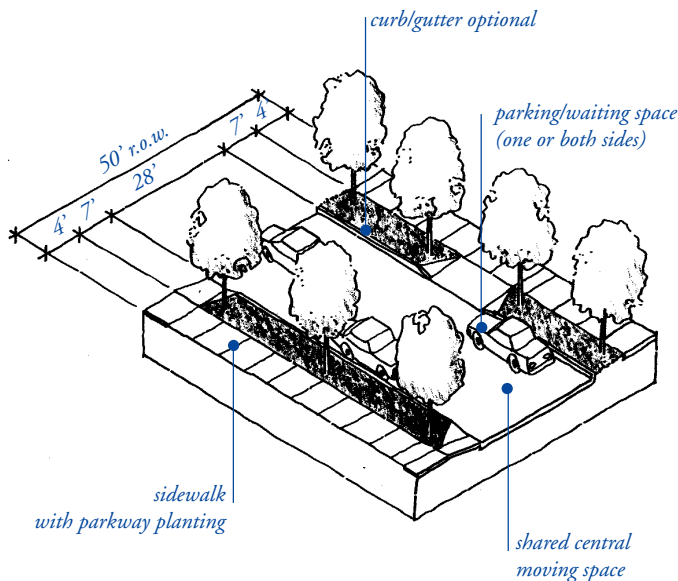

6.2a Access street: urban neo-traditional standard

74±% impervious land coverage

Two types of access streets can be built using neo-traditional standards: urban or rural.

6.2a Urban neo-traditional standard. An urban standard will utilize curbs and gutters, though the gutter may be tied to a biofilter or swale rather than an underground storm drain. According to an informational report published by the Institute of Transportation Engineers (ITE), pavement widths for neo-traditional urban streets are typically from 26 to 30' wide with a shared central moving lane, and parking permitted on one or both sides. Sidewalks are provided on at least one side of the street, though usually preferable on both sides.⁴³

6.2b Rural Standard. A rural standard can be used where aesthetics and other factors permit, with curbs and gutters replaced by gravel shoulders, further reducing construction costs and improving opportunities for stormwater infiltration. The gravel shoulders are graded to form a drainage way, with opportunities for infiltration basins, ponding and landscaping. A narrow two-lane paved roadway is provided, approximately 18 to 22 feet wide. Most of the time single vehicles use the center of the paved roadway. When two cars are present moving in opposite directions, drivers reduce speeds and move towards the right hand shoulder. Protection of the roadway edge and organiza-

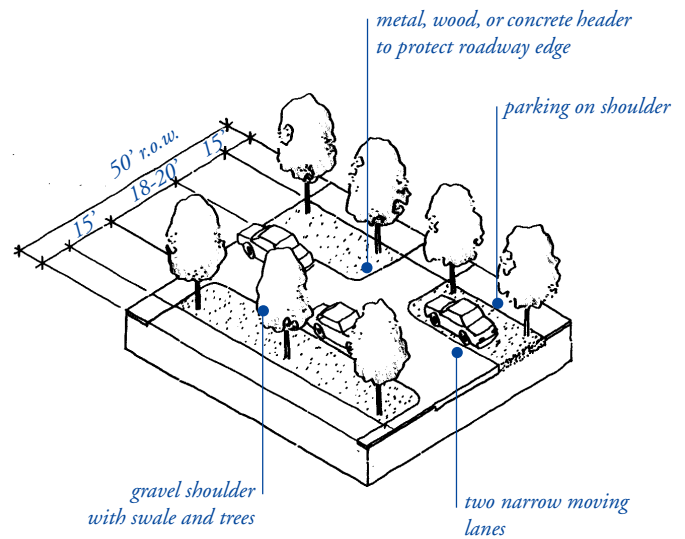

6.2b Access street: rural standard

36±% impervious land coverage

tion of parking are two issues in rural street design. Roadway edge protection can be achieved by flush concrete bands, steel edge, or wood headers. Parking can be organized by bollards, trees, or allowed to be informal. On very low volume, low speed, access streets, sidewalks may not be required, as pedestrians walk in the street or on the shoulder.

The current typical municipal street standards that mandate 80 to 100% impervious land coverage in the public right-of-way are a principal contributor to the environmental degradation caused by development. A street standard that allows a hierarchy of streets sized according to average daily traffic volumes yields a wide variety of benefits: improved safety from lower speeds and volumes, improved aesthetics from street trees and green parkways, reduced impervious land coverage, less heat island effect, and lower development costs. If the reduction in street width is accompanied by a drainage system that allows for infiltration of runoff, the impact of streets on stormwater quality can be greatly mitigated.

Street width considerations. The experience of both the pre-war traditional streets and newer subdivisions of neo-traditional design has shown that low volume streets with shared moving lanes can be safe, often safer than wider streets, because drivers are

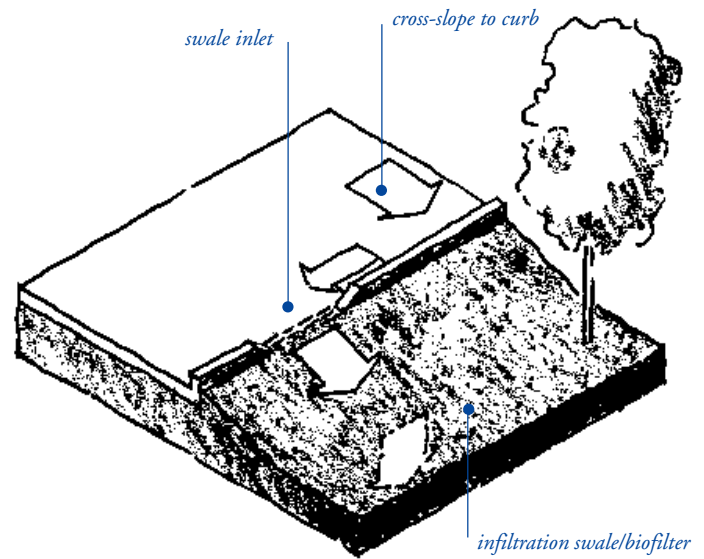

6.2c Urban curb/swale system

more cautious. These neo-traditional streets are designed for traffic speeds between 15 to 25 mph, compared to a design speed of 30 mph for most current municipal standards.⁴⁴ This reduced design speed increases safety, particularly for pedestrians. Nevertheless, shared moving space may promote unsafe conditions or high incidences of driver inconvenience if traffic volumes are much above 500-750 ADT. On access streets where bicycle traffic is especially high, such as designated bike routes or in university towns, wider streets may be advisable to provide adequate space.

Emergency service providers often raise objections to reduced street widths. Typical Fire Department standards require greater moving space for emergency access than accommodated by neo-traditional designs. A principal concern is that emergency access may be blocked if a vehicle becomes stalled in the single moving lane. Grid street systems provide multiple alternate emergency access routes to address this concern, though there may be a marginal increase in response times. Documenting the number of instances where delay has occurred in existing pre-war neighborhoods with street widths below current Fire Department standards may be a suitable way to assess the risk of this situation arising in new neighborhoods with neo-traditional street design, and to balance it with the demonstrated increased risk from higher traffic speeds on wider streets.



Inlet detail for urban curb/swale system

Just as a drop inlet collects runoff into an underground pipe system, a swale inlet collects runoff into a surface infiltration system. This swale inlet includes boulders set in soil to dissipate flow velocities and minimize erosion.

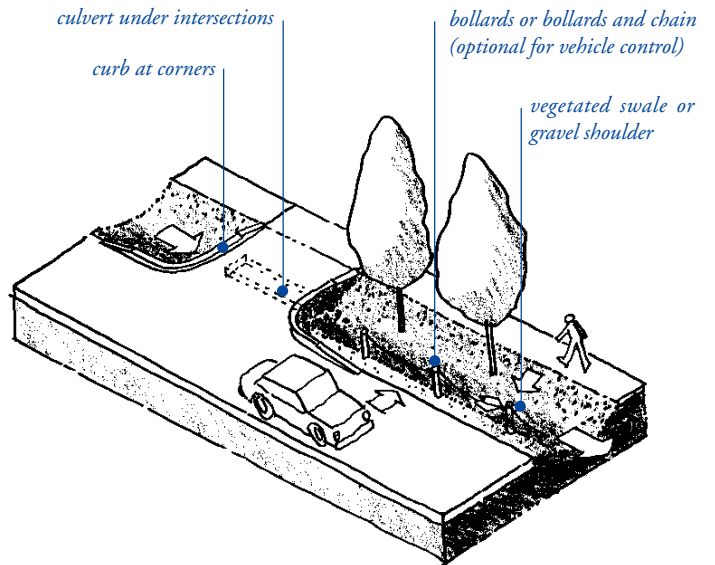

6.2d Rural swale system

Emergency service access is one factor of many that form a general assessment of neighborhood safety. One way to balance emergency service access with the benefits of access streets is to allow parking on one side only to preserve a wider moving space.

Hillside sites have special access concerns and fire risks. Because of the potential of shared moving lanes to be blocked by a single vehicle, with no comparable alternate route, reduced street widths may not be advisable on long cul-de-sac streets or narrow hillside sites.

Street drainage. Current Bay Area municipal standards generally require concrete curb and gutter along both sides of a residential street, regardless of number of houses served. The curb and gutter serves several purposes: it collects stormwater and directs it to underground conveyance drainage systems, it protects the pavement edge, it prevents vehicle trespass onto the pedestrian space, it provides an edge against which street sweepers can operate, and it helps to organize on-street parking.

Curb and gutter systems provide a directly connected conduit to natural water bodies and may act to collect and concentrate pollutants. There are two alternatives to typical curb and gutter systems that meet functional requirements while lessening the street's impact on stormwater quality.

6.2c Urban curb/swale system. On streets where a more urban character is desired, or where a rigid pavement edge is required, curb and gutter systems can be designed to empty into drainage swales. These swales can run parallel to the street, in the parkway between the curb and the sidewalk, or can intersect the street at cross angles, and run between residences, depending on topography. Runoff travels along the gutter, but instead of being emptied into a catch basin and underground pipe, multiple openings in the curb direct runoff into surface swales or infiltration/detention basins. If planted with turfgrass and gently sloped, these swales function as biofilters (see Drainage systems 5.5c). Because concentration of flow will be highest at the curb opening, erosion control must be provided, which may include a settlement basin for ease of debris removal.

6.2d Rural swale systems. On streets where a more rural character is desired, concrete curb and gutter need not be required. Since there is no hard edge to the street, the pavement margins can be protected by a rigid header of steel, wood or a concrete band poured flush with the street surface. Parking can be permitted on a gravel shoulder. If the street is crowned in the middle, this gravel shoulder also can serve as a linear swale, permitting infiltration of stormwater along its entire length. Because runoff from the street is not concentrated, but dispersed

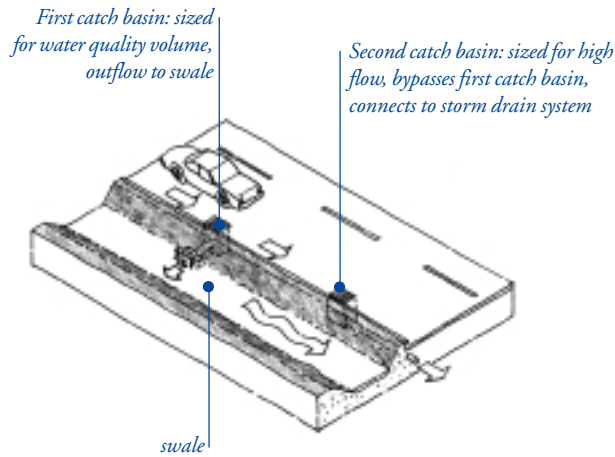

6.2e Dual drainage system

along its entire length, the buildup of pollutants in the soil is minimized. If parking is not desired on the shoulder, or if it needs to be organized, bollards, trees or groundcovers can be installed along the shoulder to prevent vehicle trespass.

In these ways edge treatments other than continuous concrete curb and gutters with underground drainage systems can be integrated into street design to create a headwaters street system that minimizes impact on stormwater quality and that captures the most attractive elements of traditional neighborhood design.

6.2e Dual drainage system. A dual drainage system is one that captures the first flush of rainfall from the 2-year storm event in a catch basin that outflows to a grass swale with small check dams. Constituents are filtered as water passes through the swale, to the outlet that directs flow back into the main storm drainage system. Runoff in excess of the 2-year storm event is captured by a second catch basin that is directly connected to the storm drain. This system can work effectively at treating the small storms while making provisions for the large storms.

Street drainage considerations. The perception that surface swale systems require a great deal of maintenance is a barrier to their acceptance. In practice, maintenance is required for all drainage systems, and surface systems can require comparable or less maintenance than underground systems. Design factors for low maintenance include:

- erosion control at curb openings
- shallow side slopes and flat bottoms (as opposed to ditches which erode)
- planting with easily maintained groundcover such as turf
- minimizing weeds through proper plant selection or installation of permeable landscape fabric.

Maintenance practices for surface systems are different than most urban Public Works Departments currently practice, and some employee retraining may be required to facilitate maintenance of street systems using surface swales instead of concrete curbs and underground pipes. One advantage of surface drainage systems is that problems, when they occur, are easy to fix because they are visible and on the surface.

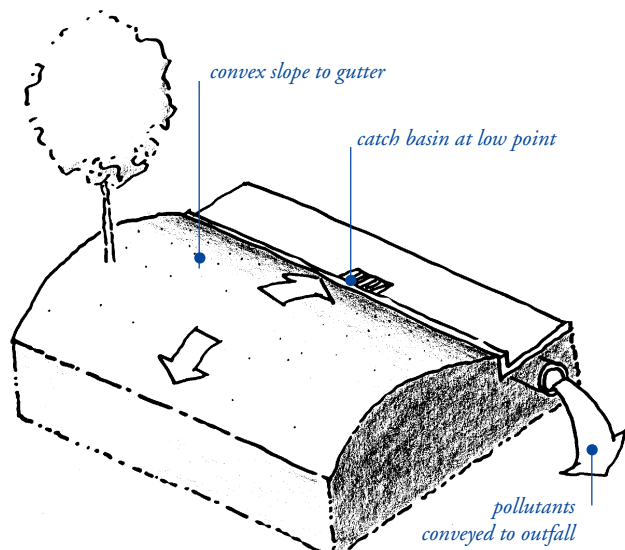

Conventional median design: convex surface

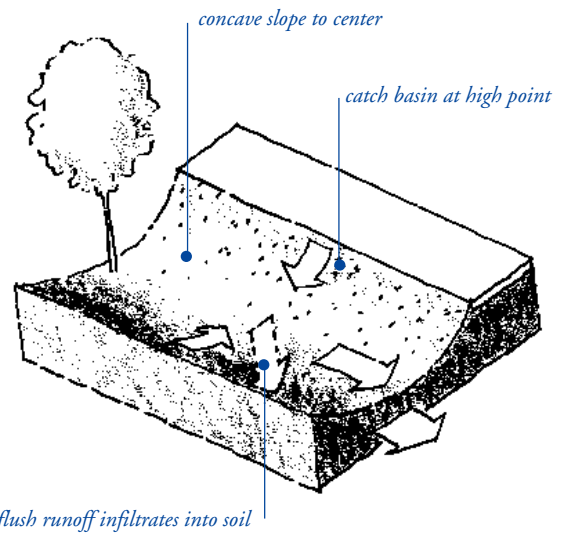

6.2f Concave median

Medians. Sometimes streets are designed with central medians to divide traffic for safety or aesthetics.

Conventional median design includes a convex surface rising above the pavement section, with drainage directed towards a curb and gutter system. Runoff is conveyed rapidly off the median and the street directly into a catch basin/underground pipe system, concentrating pollutants and carrying them to water bodies.

6.2f Concave median. If the soil level in the median is designed as a concave surface slightly depressed below the pavement section, water is directed from the street into the median.

Concave medians are especially valuable at treating the first-flush runoff, which carries a high concentration of oils and other pollutants off the street, especially if the median is designed as a landscaped swale or turf lined biofilter. Because of the relatively small area provided by the median for stormwater infiltration and retention, a catch basin and underground storm drain system may be required. By setting catch basin rim elevations just below the pavement elevation, but above the flow line of the infiltration swale, a few inches of water will collect in the swale before overflowing into the underground system.

Catch-basin design for medians.

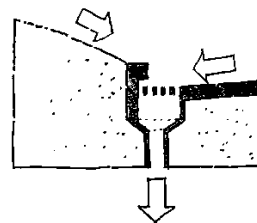

A catch basin located at the low point of a *conventional convex median* and gutter collects all runoff – including the first flush.

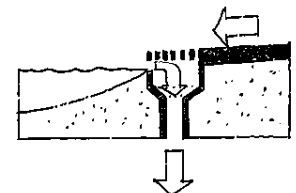

Like an overflow drain in a bathtub, a catch basin located just below the pavement surface, and a few inches above the flow line of a *concave median*, provides an opportunity to pond runoff while also providing drainage for larger storms.

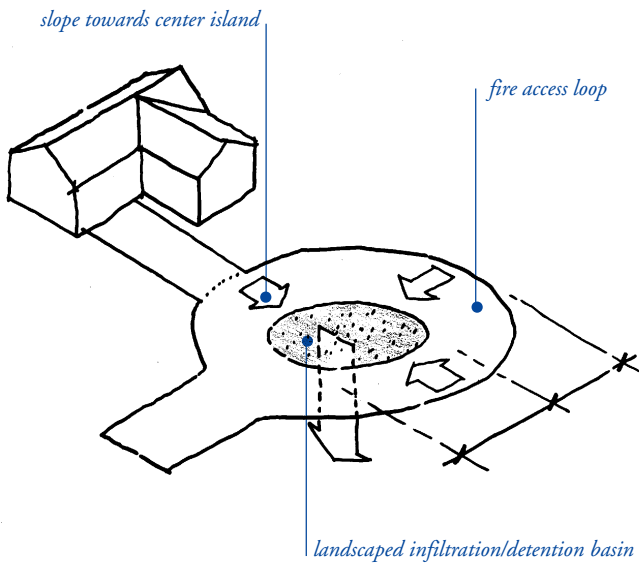

6.2g Cul-de-sac

6.2g Cul-de-sac. Cul-de-sac streets present special opportunities and challenges. Because cul-de-sac streets terminate, they require a turn-around area large enough to accommodate large trucks, such as occasional moving vans and emergency access vehicles. Fire departments, in particular, often require 60 feet or greater diameter turnarounds. If an entire 60 foot diameter turnaround is paved, it creates an 11,000 square foot impervious circle, or $\frac{1}{4}$ acre of impervious land coverage. Aside from the implications for stormwater quality, this is especially unfortunate as a design element, because it creates an unattractive heat island at the front of several homes.

A turnaround with a central concave landscaped area can create an opportunity for stormwater infiltration or detention. A landscaped area in the center of a cul-de-sac can reduce impervious land coverage 30 to 40%, depending on configuration. Design of a landscaped cul-de-sac must be coordinated with fire department personnel to accommodate turning radii and other operational needs.

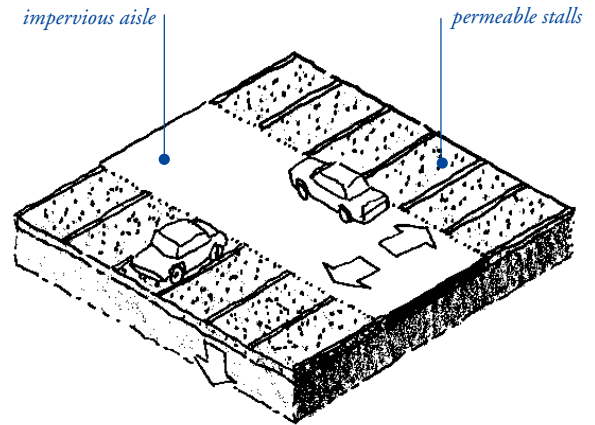

6.3a Hybrid parking lot

6.3 Parking lots. In any development, storage space for stationary automobiles can consume many acres of land area, often greater than the area covered by streets or rooftops. In a neighborhood of single family homes, this parking area is generally located on private driveways or along the street. In higher density residential developments, parking is often consolidated in parking lots.

The space for storage of the automobile, the standard parking stall, occupies only 160 square feet, but when combined with aisles, driveways, curbs, overhang space, and median islands, a parking lot can require up to 400 square feet per vehicle, or nearly one acre per 100 cars. Since parking is usually accommodated on an asphalt or concrete surface with conventional underground storm drain systems, parking lots typically generate a great deal of directly-connected impervious area.

There are many ways to both reduce the impervious land coverage of parking areas and to filter runoff before it reaches the storm drain system.

6.3a Hybrid parking lot. Hybrid lots work on the principle that pavement use differs between aisles and stalls. Aisles must be designed for speeds between 10 and 20 mph, and durable enough to support the concentrated traffic of all vehicles using

the lot. The stalls, on the other hand, need only be designed for the 2 or 3 mph speed of vehicles maneuvering into place. Most of the time the stalls are in use, vehicles are stationary. Hybrid



Hybrid parking lot.

This hybrid lot in a mixed-use development in Medford Village, N.J. uses crushed aggregate parking stalls and a conventional asphalt aisle. (photo: Bruce Ferguson)

Parking lots, continued

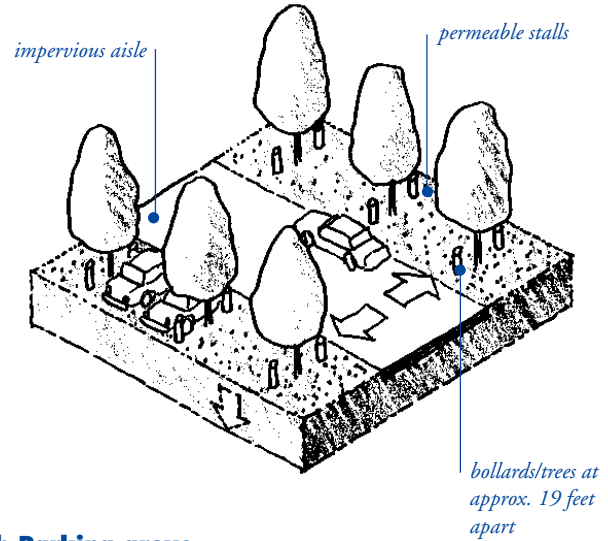

6.3b Parking grove

lots reduce impervious surface coverage in parking areas by differentiating the paving between aisles and stalls, combining impervious aisles with permeable stalls.

If the aisles are constructed of a more conventional, impermeable material suitable for heavier vehicle use, such as asphalt, the stalls can be constructed of a permeable pavement. This can reduce the overall impervious surface coverage of a typical double-loaded parking lot by 60%, and avoid the need for an underground drainage system.

Permeable stalls can be constructed of a number of materials, including crushed aggregate, open-celled unit pavers, porous asphalt, or pervious concrete (see Permeable Pavements, 6.1). A hybrid lot of crushed aggregate stalls and conventional asphalt aisles is a low-cost, practical design that is easily constructed from standard materials (see photo, previous page). In most cases, stall markings are not required, as the geometry of the edges promotes orderly parking. If desired, stalls can be indicated with wood headers, change in unit paver color, or pavement markers (“botts dots”).

6.3b Parking Grove. A variation on the permeable stall design, a grid of trees and bollards can be used to delineate parking stalls and create a “parking grove.” If the bollard and tree

grid is spaced approximately 19 feet apart, two vehicles can park between each row of the grid. This 9.5 foot stall spacing is slightly more generous than the standard 8.5 to 9 foot stall, and allows for the added width of the tree trunks and bollards. A benefit of this design is that the parking grove not only shades parked



Parking Grove.

This parking grove at a Seaside, FL. hotel uses bollards and trees at approximately 10 ft. on center to create a shady courtyard that accommodates parking. The crushed oyster shell pavement is permeable and stable for walking and driving.

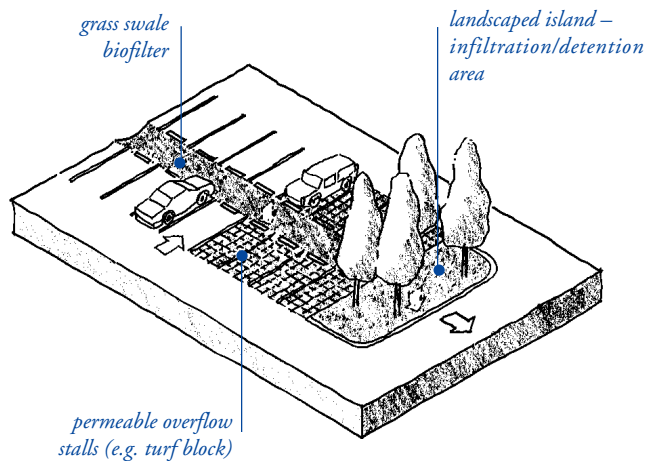

6.3c Overflow parking

cars, but presents an attractive open space when cars are absent.

6.3c Overflow parking. In some locations daily parking needs fluctuate, often with peak use occurring only for special events or seasons. Typically, parking lots must be constructed to accommodate the peak demand, generating a high proportion of impervious land coverage of very limited usefulness.

An alternative is to differentiate between regular and peak parking demands, and to construct the peak parking stalls of a different, more permeable, material. This “overflow parking” area can be made of a turf block, which appears as a green lawn when not occupied by vehicles, or crushed stone. The same concept can be applied to areas with temporary parking needs, such as emergency access routes or, in residential applications, RV or trailer parking (see 6.4f Temporary parking).

6.3d Porous pavement recharge bed. In some cases parking lots can be designed to perform more complex stormwater management functions. Subsurface stormwater storage and infiltration can be achieved by constructing a stone-filled reservoir below the pavement surface and directing runoff underground by means of perforated distribution pipes. Subsurface infiltration basins eliminate the possibilities of mud, mosqui-

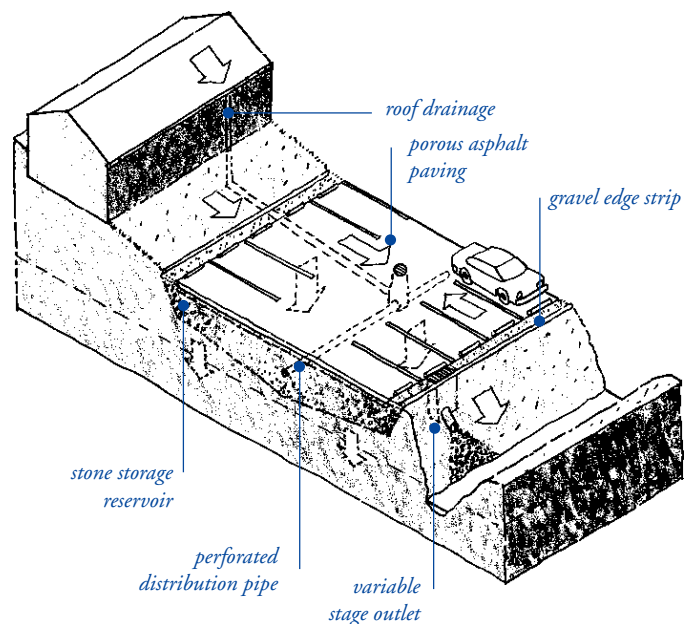

6.3d Porous pavement recharge bed

(adapted from Prince Georges Co., MD)

toes and safety hazards sometimes perceived to be associated with ephemeral surface drainage. They also can provide for storage of large volumes of runoff, and can be incorporated with roof runoff collection systems. These underground infiltration and storage systems are relatively expensive, and required extensive engineering, but have been used in a variety of locations in the eastern United States where land values are high and the need to control runoff is great.⁴⁵ Similar high land values are found throughout the Bay Area, and as emphasis on stormwater management increases, the economic viability of these solutions will increase.

Driveways

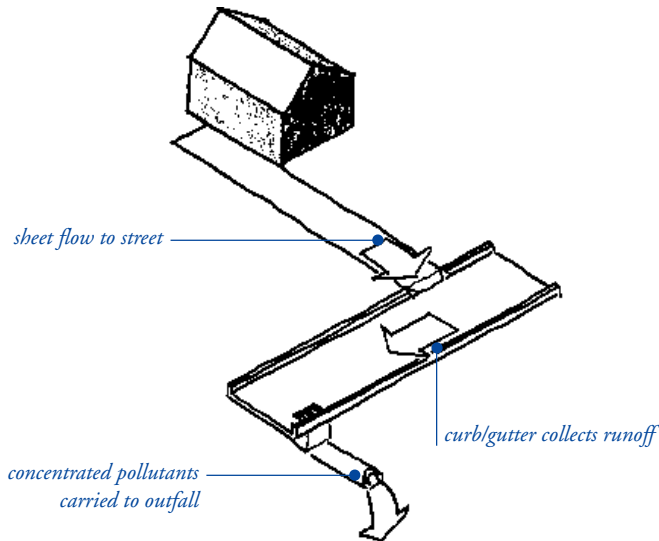

Directly-connected impervious driveway

6.4 Driveways. Driveways can comprise up to 40% of the total transportation network in a conventional development, with streets, turn-arounds and sidewalks comprising the remaining 60%.

Driveway length is generally determined by garage setback requirements, and width is usually mandated by municipal codes and ordinances. If garages are set back from the street, long driveways are required, unless a rear alley system is included to provide garage access. If parking for two vehicles side-by-side is required, a 20 foot minimum width is required. Thus, if a 20 foot setback and a two-car wide driveway are required, a minimum of 400 square feet of driveway will result, or 4% of a typical 10,000 square foot residential lot. If the house itself is compact, and the driveway is long, wide, and paved with an impervious material such as asphalt or concrete, it can become the largest component of impervious land coverage on the lot.

Municipalities can reduce the area dedicated to driveways by allowing for tandem parking (one car in front of the other). Also, if shared driveways are permitted, then two or more garages can be accessed by a single driveway, further reducing re-

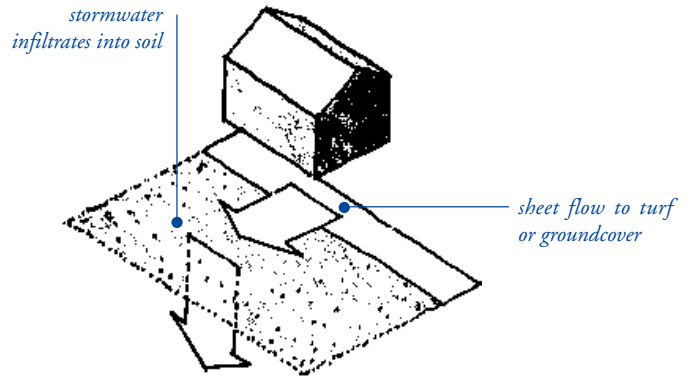

6.4a Not directly-connected impervious driveway

quired land area. Rear alley access to the garage can reduce driveway length, but overall impervious surface coverage may not be reduced if the alleys are paved with impervious materials and the access streets remain designed to conventional municipal standards.

6.4a Not directly-connected impervious driveway. A conventional driveway that is a “directly connected impervious area” drains directly to the storm drain system – collecting and concentrating pollutants. The easiest way to reduce the impact of a conventional impervious driveway on water quality is to slope it to drain onto an adjacent turf or groundcover area. By passing driveway runoff through a permeable landscaped area, pollutants can be dispersed and cleansed in the soil. A conventional impervious driveway directly connected to the storm drain network collects and concentrates pollutants.

6.4b Crushed aggregate driveway. Gravel and other granular materials can make a suitable permeable pavement for driveways especially those that serve single family homes. Because it is lightly used by very slow moving vehicles, a well-constructed driveway of granular material can serve as a relatively smooth

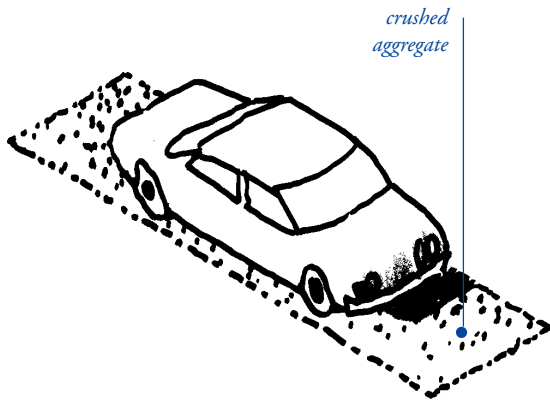

6.4b Crushed aggregate driveway

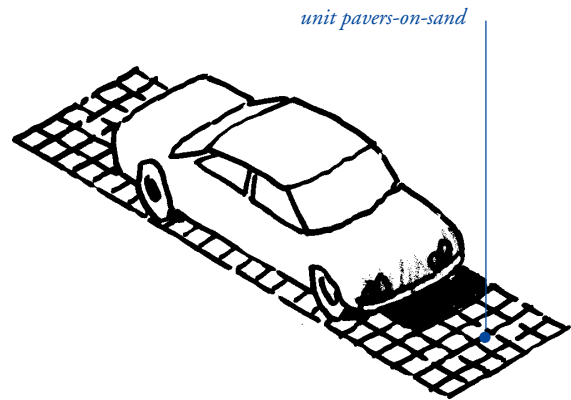

6.4c Unit pavers on sand

pavement with minimal maintenance. In choosing a granular material for a gravel driveway, use crushed stone aggregate. For proper infiltration and stormwater storage, the aggregate must be open-graded (see 6.1 Permeable pavements).

6.4c Unit pavers on sand. Unit pavers on sand can make a permeable, attractive driveway. A pavement of brick-on-sand or turf-block can make the driveway more integrated with the garden rather than an extension of the street penetrating deep into the garden space. For parking, a permeable, engineered base structural section may be required in addition to the sand setting bed.

6.4d Paving only under wheels. Concrete paving only under the wheel tracks is a viable, inexpensive design if the driveway is straight between the garage and the street. By leaving the center strip open to be planted with grass, groundcover or filled with a permeable material such as gravel, a driveway of two concrete wheel tracks can reduce impervious surface coverage by 60 to 70% compared with a single lane concrete driveway.

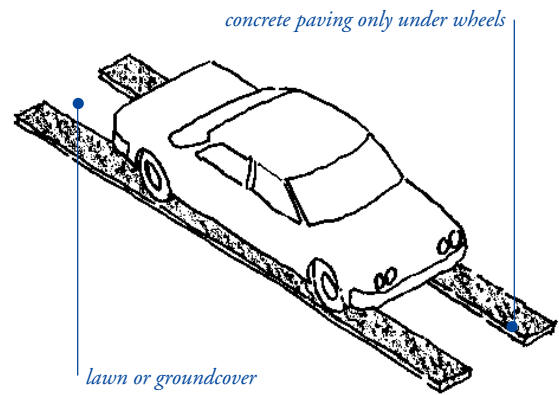

6.4d Paving only under wheels

Driveways (continued)

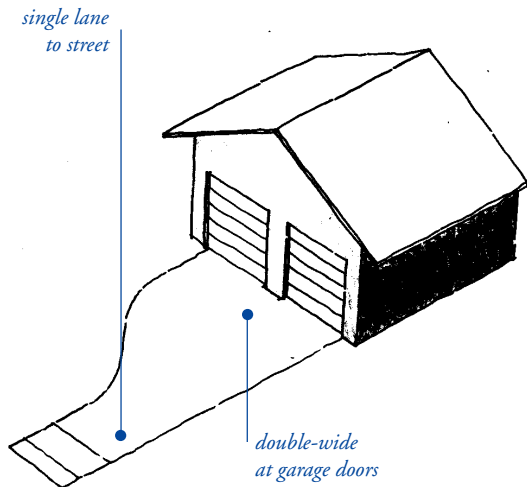

6.4e Flared driveways

6.4e Flared driveways. Long driveways or driveways that serve multi-car garages do not require the full multi-lane width along their entire length. The approach to the garage can be a single lane, adequate to accommodate the relatively infrequent vehicle trips, while the front of the garage can be flared to provide access to all garage doors. This strategy can reduce overall pavement cost and land coverage while maintaining adequate access for all parking spaces.

6.4f Temporary parking. In some areas, parking or access is required infrequently. These areas can be paved with a permeable turf-block or similar paver, and maintained as a landscaped surface. For the majority of the time when it is not used for parking, it appears and functions as a green space. When needed for parking or access, the surface supports vehicle loads. This is an especially valuable strategy for emergency access routes or overflow parking.

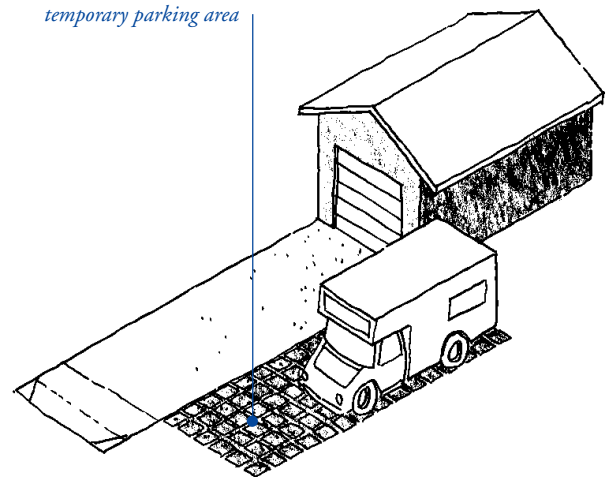

6.4f Temporary parking

Driveway considerations. Driveways offer a relatively simple opportunity to improve both the aesthetics and permeability of residential developments.

By allowing tandem parking, shared driveways, or rear alley access, municipalities can minimize mandated driveway requirements.

For designers and developers, the driveway's intimate relationship with the residence, and its relative freedom from government regulation, make it an element that can be designed to increase permeability and market appeal.

Some treatments, such as turf-block or gravel, require greater maintenance than poured-in-place asphalt or concrete designs. Other materials, such as brick or unit pavers, require a greater initial expense. Both the maintenance and cost implications of these designs can be balanced by the improved aesthetic and market appeal of driveways made from more attractive, more permeable pavements.

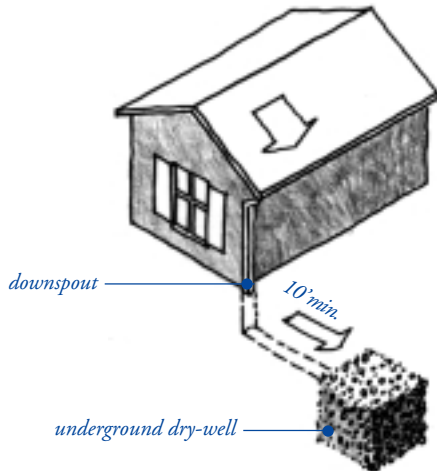

6.5a Dry-well

6.5 Buildings. By definition, buildings create impervious land coverage. An important planning consideration is the site coverage and floor area ratio (F.A.R.). Buildings of equal floor area ratio can have widely different impervious coverage. For example, a two story building with 1,000 square feet of floor area will create 500 square feet of impervious area, while a one story building of the same floor area will create twice as much impervious land coverage. Therefore, tall skinny buildings have less impact on stormwater quality than low, spreading ones.

Once the building size and coverage is determined, there are a limited number of techniques for managing runoff from individual buildings to collect rooftop runoff and allow it to infiltrate into the soil.

6.5a Dry-well. If a gutter and downspout system is used to collect rainwater that falls on a roof, runoff becomes highly concentrated. If the downspout is connected to a dry-well, this runoff can be stored and slowly infiltrated into the soil.

A dry-well is constructed by digging a hole in the ground and filling it with an open graded aggregate. An underground connection from the downspout conveys water into the dry well, allowing it to be stored in the voids. To minimize sedimentation from lateral soil movement, the sides and top of the stone

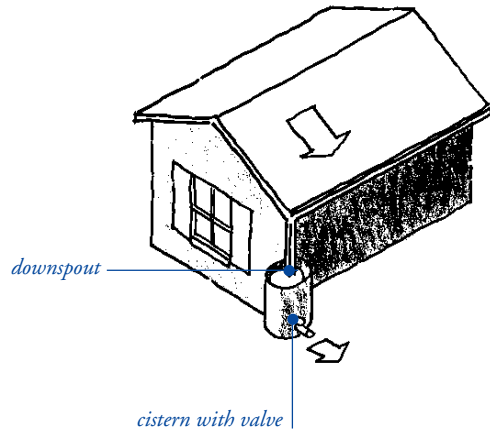

6.5b Cistern

storage matrix can be wrapped in a permeable filter fabric, though the bottom may remain open. A perforated observation pipe can be inserted vertically into the dry-well to allow for inspection and maintenance.

In practice, dry-wells receiving runoff from single roof downspouts have been successful over long periods because they contain very little sediment. They must be sized according to the amount of rooftop runoff received, but are typically 4 to 5 feet square, and 2 to 3 feet deep, with a minimum of 1 foot soil cover over the top (maximum depth of 10 feet).

To protect the foundation, dry-wells must be set away from the building at least 10 feet. They must be installed in soils that accommodate infiltration. In poorly drained soils, dry-wells have very limited feasibility.

6.5b Cistern. Another way to store and slowly release roof runoff into the soil is to empty the downspout into a cistern. A cistern is an above ground storage vessel with either a manually operated valve or a permanently open outlet.

If the cistern has an operable valve, the valve can be closed to store stormwater for irrigation or infiltration between storms. This system requires continual monitoring by the resident or

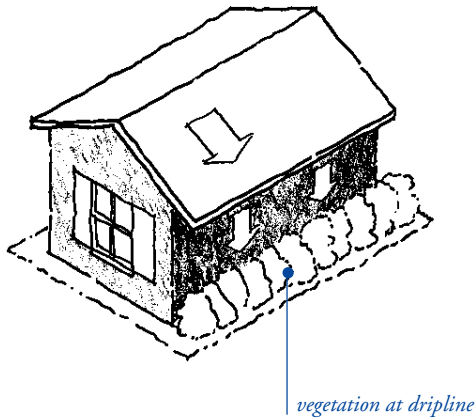

6.5c Foundation planting

grounds crews, but provides greater flexibility in water storage and metering. If a cistern is provided with an operable valve and water is stored inside for long periods, the cistern must be covered to prevent mosquitoes from breeding.

A cistern system with a permanently open outlet can also provide for metering stormwater runoff. If the cistern outlet is significantly smaller than the size of the downspout inlet (say 1/4 to 1/2 inch diameter), runoff will build up inside the cistern during storms, and will empty out slowly after peak intensities subside. This is a feasible way to mitigate the peak flow increases caused by rooftop impervious land coverage, especially for the frequent, small storms.

Cisterns can be incorporated into the aesthetics of the building and garden. Japanese, Mediterranean and American Southwest architecture provide many examples of attractive cisterns made of a variety of materials.

If a cistern holds more than 6" depth of water, it must be covered securely or have a top opening of 4" or less to prevent small children from gaining access to the standing water. The cistern must be designed and maintained to minimize clogging by leaves and other debris.

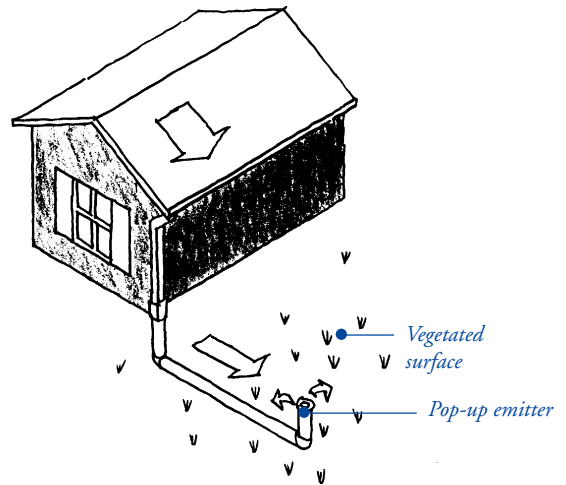

6.5d Pop-up drainage emitter

6.5c Foundation planting. For buildings that do not use a gutter system, landscape planting around the base of the eaves can provide increased opportunities for stormwater infiltration and protect the soil from erosion caused by concentrated sheet flow coming off the roof.

Foundation plantings can reduce the physical impact of water on the soil and provide a subsurface matrix of roots that encourage infiltration. These plantings must be sturdy enough to tolerate the heavy runoff sheet flows, and periodic soil saturation.

6.5d Pop-up drainage emitter. Discharging the downspout to landscaped areas allows for polishing and infiltration of the runoff. The downspout can be directly connected to a pipe which daylight some distance from the building foundation, releasing the roof runoff through a pop-up emitter. Similar to a pop-up irrigation head, the emitter only opens when there is flow from the roof. The emitter remains flush to the ground during dry periods, for ease of lawn or landscape maintenance.

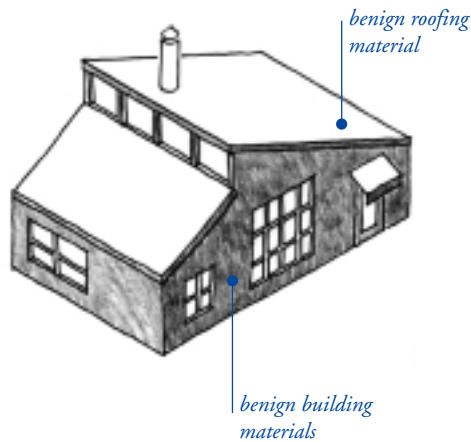

6.5e Building materials

6.5e Building materials. Selection of building materials and construction practices has an affect on stormwater quality. Some building materials contribute to stormwater degradation as they age or combine with rainwater and air. Some construction practices use materials that pollute runoff. Other materials and practices are more benign. Examples of considerations in materials selection and building practices include:

Concrete. Check the contents and source of the concrete mixture for impurities. Avoid form separators such as diesel fuel or petroleum based oil. Vegetable oil can be used as a non-toxic alternate (though plaster and stucco may not adhere effectively to an oiled concrete substrate).

Wood. For landscape materials such as steps and walls, avoid using railroad ties and woods that have been pressure treated with creosote or penta wood preservatives. Many recycled plastic products are becoming more commonly available and are often suitable wood substitutes for decking, headers and other

landscape uses. Steel studs and frames are also becoming a cost-effective substitute for wood framing.

Roofing. Materials that can generate polluted runoff under some conditions include copper sheeting (trace metal), asphalt shingles (by-product of oil refining process), zinc (trace metal; lead used in zincing process). Some alternative roofing materials include: slate, steel, stone, and terra cotta tiles. These materials are durable and fireproof. They may also require design attention to accommodate the added weight load.

Paints and coatings. Lead-based paints have been commonly used in building. White lead was used on wood siding, door and window frames, and casings. Red lead was used as a primer for steel window frames on commercial and industrial buildings. When renovating old buildings, test for lead in the existing paint before proceeding with removal practices such as sanding or water blasting to avoid paint chips landing on and leaching into the soil.

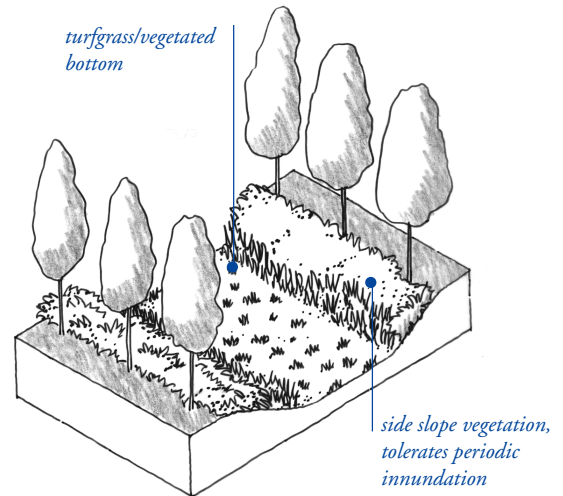

6.6a Grass/vegetated swales

6.6 Landscape. In the natural landscape, most soils infiltrate a high percentage of rainwater through a complex web of organic and biological activities that build soil porosity and permeability. Roots reach into the soil and separate particles of clay, insects excavate voids in the soil mass, roots decay leaving networks of macropores, leaves fall and form a mulch over the soil surface, and earthworms burrow and ingest organic detritus to create richer, more porous soil. These are just a few examples of the natural processes that occur within the soil.⁴⁶

In development, a certain amount of soil must be covered with impervious surface, but the remaining landscape can be designed and maintained to maximize its natural permeability and infiltration capacity.

One simple strategy to improve infiltration is to use the grading of landscape surfaces. Landscape surfaces are conventionally graded to have a slight convex slope. This causes water to run off a central high point into a surrounding drainage system, creating increased runoff. If a landscape surface is graded to have a slightly concave slope, it will hold water. The infiltration value of concave vegetated surfaces is greater in permeable soils. Soils of heavy clay or underlain with hardpan provide less infiltration value. In these cases concave vegetated surfaces must be

designed as retention/detention basins, with proper outlets or underdrains to an interconnected system.

Multiple small basins. Biofilters, infiltration, retention/detention basins are the basic elements of a landscape designed for stormwater management (see Drainage system elements 5.5). The challenge for designers is to integrate these elements creatively and attractively in the landscape – either within a conventional landscape aesthetic, or by presenting a different landscape image that emphasizes the role of water and drainage.

Multiple small basins can provide a great deal of water storage and infiltration capacity. These small basins can fit into the parkway planting strip or shoulders of street rights-of-way. If connected by culverts under walks and driveways, they can create a continuous linear infiltration system. Infiltration and retention/detention basins can be placed under wood decks, in parking lot planter islands, and at roof downspouts. Outdoor patios or seating areas can be sunken a few steps, paved with a permeable pavement such as flagstone or gravel, and designed to hold a few inches of water collected from surrounding rooftops or paved areas for a few hours after a rain.

All of these are examples of small basins that can store water for



An ordinary lawn.

This lawn presents a conventional landscape appearance – its role as an effective biofilter capable of holding a few inches of water is barely noticeable.



A different landscape image.

This infiltration basin uses simple landscape materials to create a landscape of great diversity that accentuates its role in a surface drainage network.

Basins for every landscape type.

a brief period, allowing it to infiltrate into the soil, slowing its release into the drainage network, and filtering pollutants.

6.6a Grass/vegetated swales. Parking lot drainage can be integrated with landscaping to provide infiltration and retention/detention basins. Grass swales can be a particularly effective design strategy in large conventionally paved parking lots, by providing low maintenance, linear biofilters along the perimeter of the lot or along internal islands. Stormwater is directed to these linear landscaped spaces and travels slowly over turfgrass or other vegetated surfaces, allowing pollutants to settle and slowing runoff velocities (See chapter 8 for details).

6.6b Extended detention (dry) ponds. Extended detention (dry) ponds can be used for both pollutant removal and flood control. These ponds store water during storms anywhere from a few hours up to a few days, discharge it to adjacent surface waters, and are dry between storms. Clay or impervious soils should not affect pollutant removal effectiveness, as the main removal mechanism is settling.

Extended detention ponds are generally appropriate for developments of ten acres or larger, and have the potential for multiple uses including flood control basins, parks, playing fields, tennis courts, open space, and overflow parking lots.

It is important to consider design elements to improve pond safety. The most important being shallow side slopes of no steeper than 3:1. This prevents people from accidentally falling into deep water. Barriers such as fencing and/or vegetation are also used, but they prevent access for recreational use, and also can present a hazardous situation if the side slopes are steep, because people drawn to the water can breach or climb the barrier and fall into deep water.

6.6c Wet ponds. Wet ponds are permanent pools of water that detain and treat stormwater runoff. These ponds, if designed with a fringe wetland at the pond edge, can increase property values by providing a significant landscape amenity with opportunities for passive recreation (e.g., birdwatching, fishing), and can be combined with pedestrian and bicycle circulation to provide active recreation. The fringe wetland is also an important factor in increasing pollutant removal.

6.6d Plant species selection for infiltration areas. The proper selection of plant materials can improve the infiltration potential of landscape areas. Deep rooted plants help to build soil porosity. Plant leaf-surface area helps to collect rainwater before it lands on the soil, especially in light rains, increasing the overall water-holding potential of the landscape. A single street tree can have a total leaf surface area of several hundred to

Landscape, continued

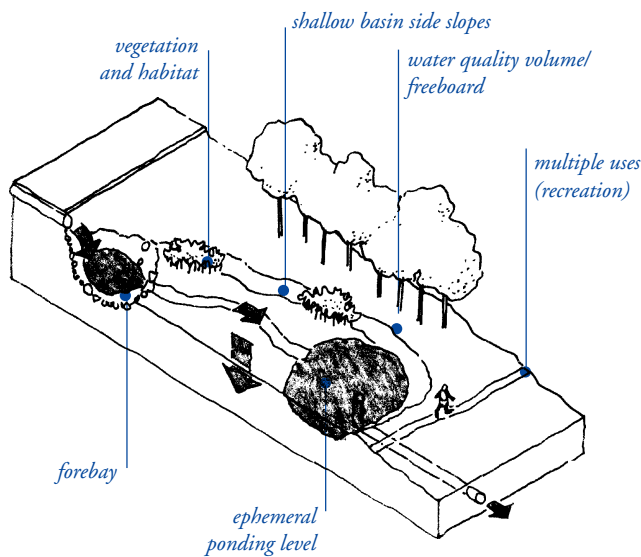

6.6b Extended detention (dry) ponds

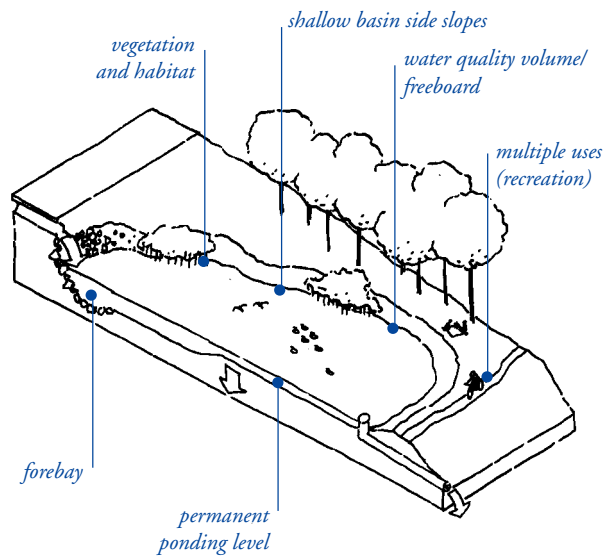

6.6c Wet ponds

several thousand square feet, depending on species and size. This above ground surface area created by trees and other plants greatly contributes to the water-holding capacity of the land.

A large number of plant species will survive moist soils or periodic inundation. These plants provide a wide range of choices for planted infiltration/detention basins and drainage swales. Most inundated plants have a higher survival potential on well-drained alluvial soils than on fine-textured shallow soils or clays. Though oaks generally do not tolerate summer moisture, mature valley and blue oaks (*Quercus lobata* and *Q. douglasii*) in alluvial soils can survive winter inundation for up to 100 days annually.⁴⁷

Landscape considerations. Landscape can perform a wide variety of stormwater management functions. In designing landscapes for stormwater management, appropriate groundcover must be selected. Turf grass lawns, woody perennials, and cobbles can all be used, depending on the desired aesthetic effect.

6.6e Landscape maintenance for stormwater systems.

All landscape treatments require maintenance. Landscapes designed to perform stormwater management functions are not necessarily more maintenance intensive than highly manicured conventional landscapes. A concave lawn requires the same mowing, fertilizing and weeding as a convex one, and often less irrigation because more rain is filtered into the underlying soil. Sometimes infiltration basins may require a different kind of maintenance than conventionally practiced.

Typical maintenance activities include periodic inspection of surface drainage systems to ensure clear flowlines, repair of eroded surfaces, adjustment or repair of drainage structures, soil cultivation or aeration, care of plant materials, replacement of dead plants, replenishment of mulch cover, irrigation, fertilizing, pruning and mowing. Also, dead or stressed vegetation may indicate chemical dumping. Careful observation should be made of these areas to determine if such a problem exists.

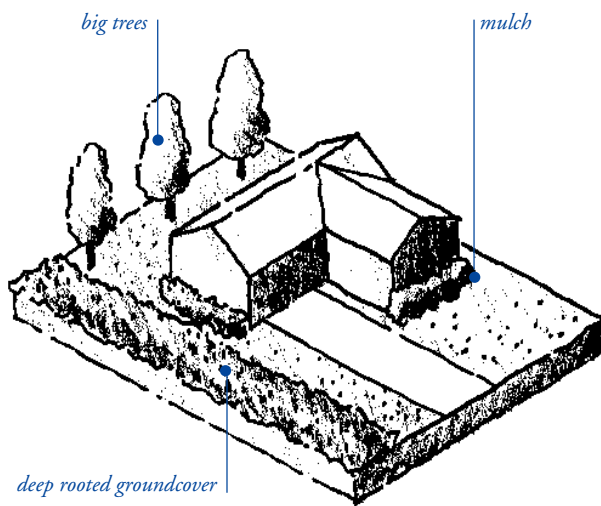

6.6d/e Plant selection and landscape maintenance

Landscape maintenance can have a significant impact on soil permeability and its ability to support plant growth. Most plants concentrate the majority of their small absorbing roots in the upper 6 inches of the soil surface if the surface is protected by a mulch or forest litter. If the soil is exposed or bare, it can become so hot that surface roots will not grow in the upper 8 to 10 inches. The common practice of removing all leaf litter and detritus with leaf blowers creates a hard crusted soil surface of low permeability and high heat conduction. Proper mulching of the soil surface improves water retention and infiltration, while protecting the surface root zone from temperature extremes.⁴⁷

In addition to impacting permeability, landscape maintenance practices can have adverse effects on water quality. Because commonly used fertilizers and herbicides are a source of organic compounds, it is important to keep these practices to a minimum, and prevent overwatering.

When well-maintained and designed, landscaped concave surfaces, infiltration basins, swales and bio-retention areas can add aesthetic value while providing the framework for environmentally sound, comprehensive stormwater management systems.

Outdoor work areas

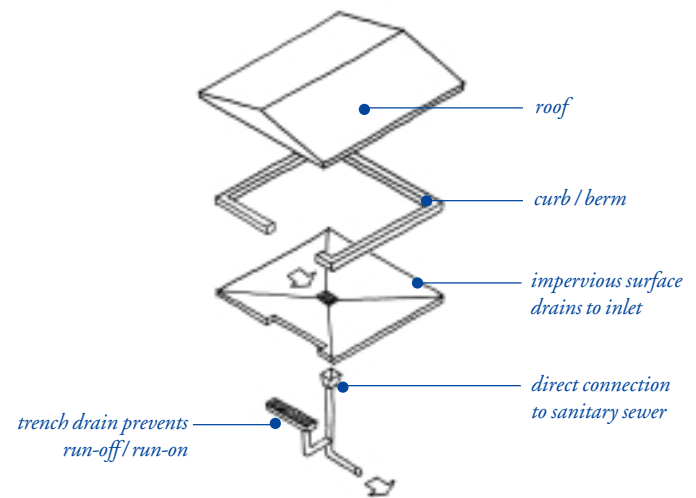

6.7 Typical outdoor work area

6.7 Outdoor work areas. The site design and landscape details listed in previous chapters are appropriate for uses where low concentrations of pollutants can be mitigated through infiltration, retention and detention. Often in commercial and industrial sites, there are outdoor work areas in which a higher concentration of pollutants exists, and thus a higher potential of pollutants infiltrating the soil. These work areas often involve automobiles, equipment, machinery, or other commercial and industrial uses, and require special consideration.

Outdoor work areas are usually isolated elements in a larger development. Infiltration and detention strategies are still appropriate for and can be applied to other areas of the site, such as parking lots, landscape areas, employee use areas, and bicycle paths. It is only the outdoor work area within the development – such as the loading dock, fueling area, or equipment wash – that requires a different drainage approach. This drainage approach is often *precisely the opposite* from the infiltration/detention strategy – in other words, collect and convey.

In these outdoor work areas, infiltration is discouraged and runoff is often routed directly to the sanitary sewer, not the storm drain. Because this runoff is being added to the loads normally received by the water treatment plants (known as “publicly owned treatment works” or POTW), it raises several concerns

that must be addressed in the planning and design stage. These include:

- higher flows (if area is exposed to rainfall) that could exceed the sewer system capacity,
- catastrophic spills that may cause harm to POTW operations, and,
- a general increase in pollutants.

These concerns can be addressed at policy, management, and site planning levels.

Policy. Piping runoff and process water from outdoor work areas directly to the sanitary sewer for treatment by a downstream POTW displaces the problem of reducing stormwater pollution. Municipal stormwater programs and/or private developers can work with the local POTW to develop solutions that minimize effects on the treatment facility.

Management. Commercial and industrial sites that host special activities need to implement a pollution prevention program, minimizing hazardous material use and waste. For example, if restaurant grease traps are directly connected to the sanitary sewer, proper management programs can mitigate the amount of grease that escapes from the trap. This grease, if released in large volumes, can clog sewer systems and cause overflows, or

Outdoor work areas

Outdoor work areas that may require structural treatment include:

Auto recycle facilities

Auto wrecking yards

Commercial nurseries

Corporation yards

Fueling stations

Fleet storage areas

Rooftop equipment

Marinas

Outdoor container storage

Outdoor loading/unloading facilities

Public works storage areas

Vehicle service and maintenance areas

Vehicle and equipment washing/steam cleaning facilities

All sites requiring a hazardous materials management plan (HMMP)

Source: Technical Note No. 87. *Watershed Protection Techniques*. Vol. 2, No. 2. February 1997.

damage the downstream treatment system.

Site Planning. Outdoor work areas can be designed in particular ways to reduce their impacts on both stormwater quality and sewage treatment plants (if drainage system is connected):

- create an impermeable surface. This can be a conventional pavement, such as concrete or asphalt, or a prefabricated metal drip pan, depending on the use.
- cover the area with a roof. This prevents rain from falling on the work area and becoming polluted runoff.
- berm or mounding around the perimeter of the area to prevent water from adjacent areas to flow on to the surface of the work area. In this way, the amount of polluted runoff is minimized.
- directly connect runoff. Unlike other areas, runoff from these work areas is directly connected to the sanitary sewer or other specialized containment systems. This allows the more highly concentrated pollutants from these areas to receive special treatment that removes particular constituents. Approval for this connection must be obtained from the appropriate sanitary sewer agency.
- locate the work area away from storm drains or catch basins. If the work area is adjacent to or directly upstream from a storm drain or landscape drainage feature (e.g.

Outdoor work areas, continued

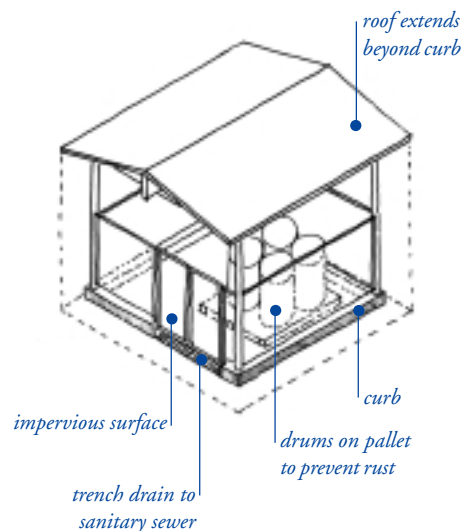
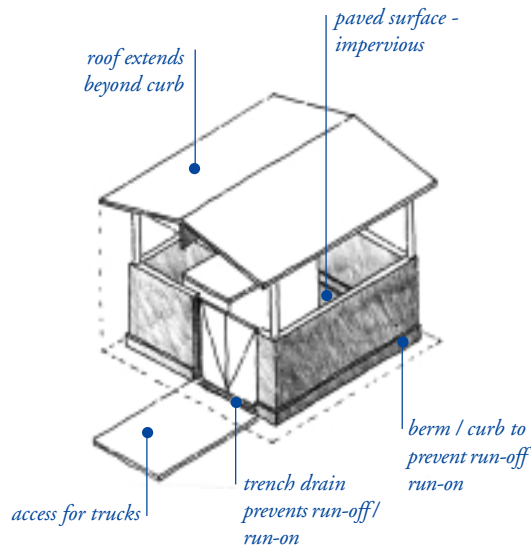

6.7a Garbage and recycling area

6.7b Maintenance and storage area

bioswale), debris or liquids from the work area can migrate into the stormwater system.

These design elements are general considerations for work areas. In designing any outdoor work area, evaluate local ordinances affecting the use, as many local jurisdictions have specific requirements.

Some activities are common to many commercial and industrial sites. These include garbage and recycling, maintenance and storage, and loading. These activities can have a significant negative impact on stormwater quality, and require special attention to the siting and design of the activity area.

6.7a Garbage and recycling. Garbage and recycling areas must be designed to consider a wide range of factors. These include sizes of receptacles for both trash and a variety of recycled materials. They must be sited so that receptacles are accessible for collection by standard collection trucks, yet out of the way so as not to disturb the aesthetics of the site. Garbage and recycling areas should also be located away from drainage paths and waterways to prevent debris and spills from entering the drainage system.⁴⁹ Regular maintenance plans should be implemented for sweeping, litter control, and spill cleanup.

Protection from rainfall and “run-on” surface drainage can be achieved by designing a roof or covering for the enclosure, and a curb or berm around the perimeter to contain any leakage from trash containers and dumpsters. The dumpsters or trash containers need to sit on a paved area, not lawn or unpaved soil, to prevent infiltration of leakage. Plastic liners may also be used to contain liquid waste. In cases where water cannot be diverted from the areas (such as areas located within a low spot), a self-contained drainage system must be designed.

6.7b Maintenance and storage. To reduce the possibility of contact with stormwater runoff, maintenance and storage areas can be sited away from drainage paths and waterways.⁵⁰ Implementing a regular maintenance plan for sweeping, litter control, and spill cleanup, also helps prevent stormwater pollution.

Specifying impermeable surfaces for vehicle and equipment maintenance areas will reduce the chance of pollutant infiltration. A concrete surface will usually last much longer than an asphalt one, as vehicle fluids can either dissolve asphalt or can be absorbed by the asphalt and released later.⁵¹

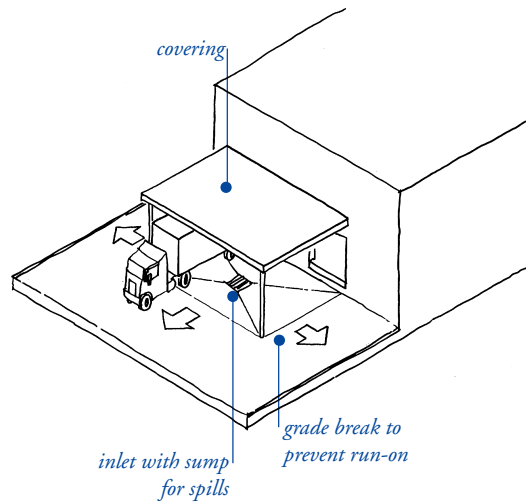

6.7c Loading area

Vehicle and equipment washing. It is generally advisable to cover areas used for regular washing of vehicles, trucks, or equipment, surround them with a perimeter berm, and clearly mark them as a designated washing area. Sumps or drainlines can be installed to collect wash water, which may be treated for reuse or recycling, or for discharge to the sanitary sewer. The POTW may require some form of pretreatment, such as a trap, for these areas.

Fueling and maintenance activities must be isolated from the vehicle washing facilities. These activities have specific requirements (see below).

Storage of bulk materials, fuels, oils, solvents, other chemicals, and process equipment should be accommodated on an impervious surface covered with a roof. To reduce the chances of corrosion, materials should not be stored directly on the ground, but supported by a wire mesh or other flooring above the impervious pavement. In uncovered areas, drums or other containers can be stored at a slight angle to prevent ponding of rainwater from rusting the lids. Liquid containers should be stored in a designated impervious area that is roofed, fenced

within a berm, to prevent spills from flowing into the storm drain.

If hazardous materials are being used or stored, additional specific local, state or federal requirements may apply.

6.7c Loading. Loading areas and docks can be designed with a roof or overhang, and a surrounding curb or berm. The area should be graded to direct flow toward an inlet with a shutoff valve or dead-end sump. The sump must be designed with enough capacity to hold a spill while the valve is closed. If the sump has a valve, it must be kept in the closed position and require an action to open it. All sumps must have a sealed bottom so they cannot infiltrate water. Contaminated accumulated waste and liquid must not be discharged to a storm drain and may be discharged to the sanitary sewer only with the POTW's permission. If it does not receive approval for discharge to the sanitary sewer, it must be conveyed to a hazardous waste (or other offsite disposal) facility, and may require pretreatment.⁵²

Outdoor work areas, continued

Some specific uses have unique requirements.

Restaurants. Though special regulations and zoning ordinances address restaurant pollutants, there are still areas in which poor maintenance practices contribute to stormwater pollution. It is preferable that all cooking and cleaning activities occur inside the restaurant. If these activities are performed outside, there are some simple site design elements that can help reduce the potential for stormwater pollution (See case study 7.2f).

Containment curbs or berms can be designed around areas in which floor mat, container washing, exhaust filter and sink cleaning may take place. A covered, secondary containment area can be designed so that kitchen grease is contained, collected, and removed regularly by a recycling/disposal service, or disposed of through a grease trap with a sanitary sewer connection.⁵³

Fueling areas. In all vehicle and equipment fueling areas, plans must be developed for cleaning near fuel dispensers, emergency spill cleanup, and routine inspections to prevent leaks and ensure properly functioning equipment.⁵⁴

If the fueling activities are minor, fueling can be performed in a designated, covered and bermed area that will not allow run-on of stormwater or runoff of spills.⁵⁵

Retail gasoline outlets and vehicle fueling areas have specific design guidelines (See case study 7.2g). These are described in a Best Management Practice Guide for retail gasoline outlets developed by the California Stormwater Quality Task Force, in cooperation with major gasoline corporations. The practice guide addresses standards for existing, new, or substantially remodeled facilities.

Fuel dispensing areas are defined as extending 6.5 feet from the corner of each fuel dispenser or the length at which the hose and nozzle assemble may be operated plus 1 foot, whichever is less. These areas must be paved with smooth impervious surface, such as Portland cement concrete, with a 2%-4% slope to prevent ponding, and must be covered. The cover must not drain onto the work area. The fuel dispensing area must be separated by the rest of the site by a grade break that prevents run-on of stormwater.

Within the gas station, the outdoor trash receptacle area (garbage and recycling), and the air/water supply area must be paved and graded to prevent stormwater run-on.

7 Case Studies

The site planning principles and design concepts described in the previous pages are integrated on the following pages in a series of case studies reflecting the diverse topography and market conditions of the Bay Area.

The case studies are illustrative. They show an approach to site planning and design that integrates stormwater management as an organizing element. Each of the details in Chapter 6 is illustrated at least once to show how the details work in combination with each other. Real sites, and real projects, will require unique combinations to suit unique conditions.

Site planning and design is a complex and demanding process. To be successful, a new development must meet marketing, economic, regulatory, engineering, environmental, construction, and design criteria. The following case studies attempt to show that by treating stormwater as a resource, and using it as a means to generate design, communities can be built that reward investment, enhance the natural environment, and make better places for people to live and work.

Case Studies

Economic benefits of stormwater management

7.1 Residential development

- 7.1a Small single lot
- 7.1b Large single lot
- 7.1c High density multi-family site
- 7.1d Small hillside site
- 7.1e Large hillside site
- 7.1f Large flat site

7.2 Commercial/industrial/institutional development

- 7.2a Shopping center
- 7.2b Industrial park
- 7.2c Strip mall
- 7.2d Schools and parks
- 7.2e Office building
- 7.2f Restaurant
- 7.2g Gas stations
- 7.2h Hotel/motel

Economic benefits of stormwater management

People have a strong emotional attachment to water, arising from its aesthetic qualities—tranquility, coolness and beauty. As a result, most waterbodies within developments can be used as marketing tools to set the tone for entire projects. A recent study conducted by the National Association of Home Builders indicates that “whether a beach, pond, or stream, the proximity to water raises the value of a home by up to 28 percent.”⁵⁶

In California’s semi-arid climate, most of the techniques described in this document will not be year-round water features, but instead will hold water only during the rainy months. These ephemeral ponds and streams have a unique character, changing with the seasons and reflecting (literally) daily changes in weather.

Water features command a premium in the marketplace.

Homebuyers and renters nation-wide demonstrate a willingness to pay a premium for properties adjacent to urban runoff controls that are designed with aesthetics in mind. According to the US E.P.A., land values for lots fronting runoff controls commanded 5 to 15% premiums over comparable lots at residential projects in Virginia, Colorado, Illinois and Kansas. In Davis, California, properties at Village Homes, a residential subdivision built in the late 1970s with seasonal swales and other environmental features, command significantly higher values than comparable homes in nearby conventionally designed subdivisions.

Stormwater management for water quality presents developers with an opportunity to design more attractive projects that will have an advantage over conventionally designed competitors. Not only do subdivisions sell faster and at a premium, but development costs are generally lower for surface drainage systems compared to conventional underground systems.⁵⁷

Factors that lead to increases in property values. Urban runoff systems that appear to be natural systems are most effective at commanding increases in property values. If recreation is included (e.g. a walking path along a swale or playfield/infiltration basin), an additional premium is realized. These recreational areas and wetlands can become a feature attraction when advertising the property. Amenities such as trails and gazebos may add costs, but these can be compensated for by faster sales and additional profits. Developers can charge premiums for properties with water views, stream frontage, access to greenbelts, or other amenities.

Maintenance. Proper maintenance of the drainage system is essential for homebuyer acceptance and marketing. Runoff controls that are poorly maintained can be a hazard or a nuisance. Maintenance costs need not be significantly higher than conventionally designed projects. For example, a concave lawn requires the same maintenance as a convex one, though the concave lawn can form part of a stormwater management system. In some designs, such as vegetated swales or seasonal ponds, periodic maintenance will be required, but it is less than other amenities routinely included in new development, such as fountains or tennis courts.

Green marketing. Many consumers today demonstrate a preference for products and services that are “environment friendly.” Organically grown cotton clothing, natural foods, and recycled papers are a few of the products that sell at a premium to conventional competitors but command increasing market share. Homebuyers, too, respond to products that consciously promote more environmentally responsible designs, as long as these designs are safe, attractive and functional. By promoting a natural drainage system, developers can meet federal mandates for environmental quality while simultaneously differentiating their product through increased habitat, a more diverse landscape, and additional recreational opportunities.

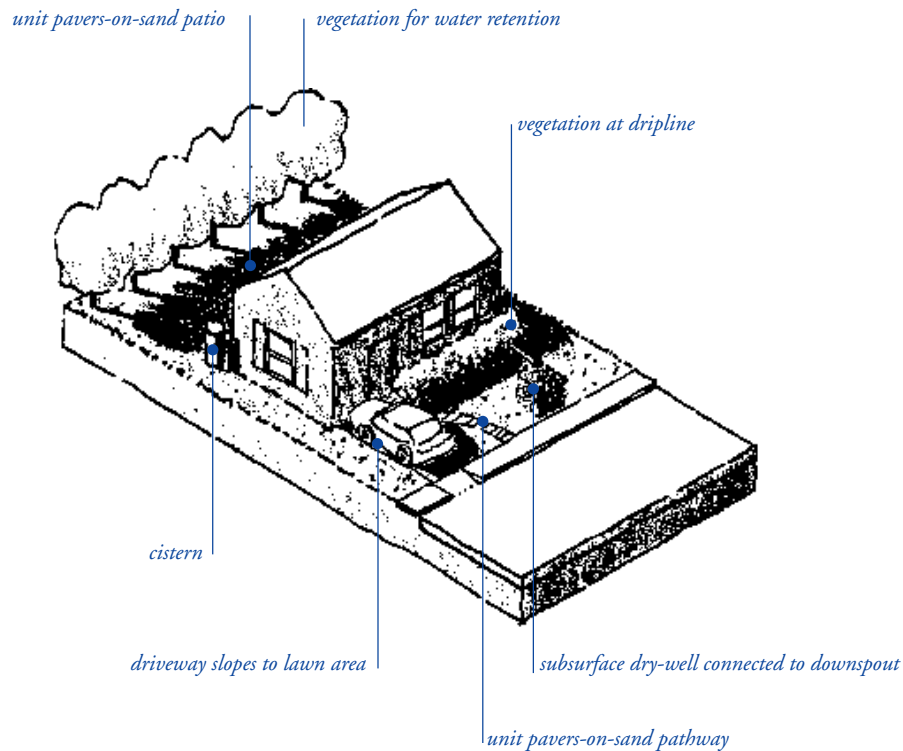

This drainage swale, integrated with a pathway system and landscaping, makes an attractive recreational area that enhances property values.

Small single lot

7.1a Small single lot. Even a small, single-family home lot can provide opportunities for stormwater management. Because they occur at the intimate, garden level, these opportunities can add aesthetic richness that will directly benefit residents. Stormwater management techniques can also provide habitat for wildlife, create shade, improve character, provide supplemental irrigation water, and promote growth of landscape planting.

Homeowner education is an important element of stormwater management techniques at all levels, but especially at the single lot scale. Residents need to be educated on the intent of various design elements, and their proper care. They especially need to understand the maintenance needs of more active elements, such as cisterns, which need periodic cleaning or emptying. If dry-

wells are included, residents must also understand that they are for rainwater only – never as a place to dump oil, pesticides, paint thinner, solvents, cleaners such as 409, degreasers, or other unwanted wastes.

The techniques illustrated in this example are:

- unit pavers-on-sand patio
- not directly connected impervious driveway
- unit pavers-on-sand pathway
- dry-well connected to roof downspout
- cistern
- vegetation for water retention (deep rooted trees)
- vegetation at dripline of roof.

7.1b *Large single lot*

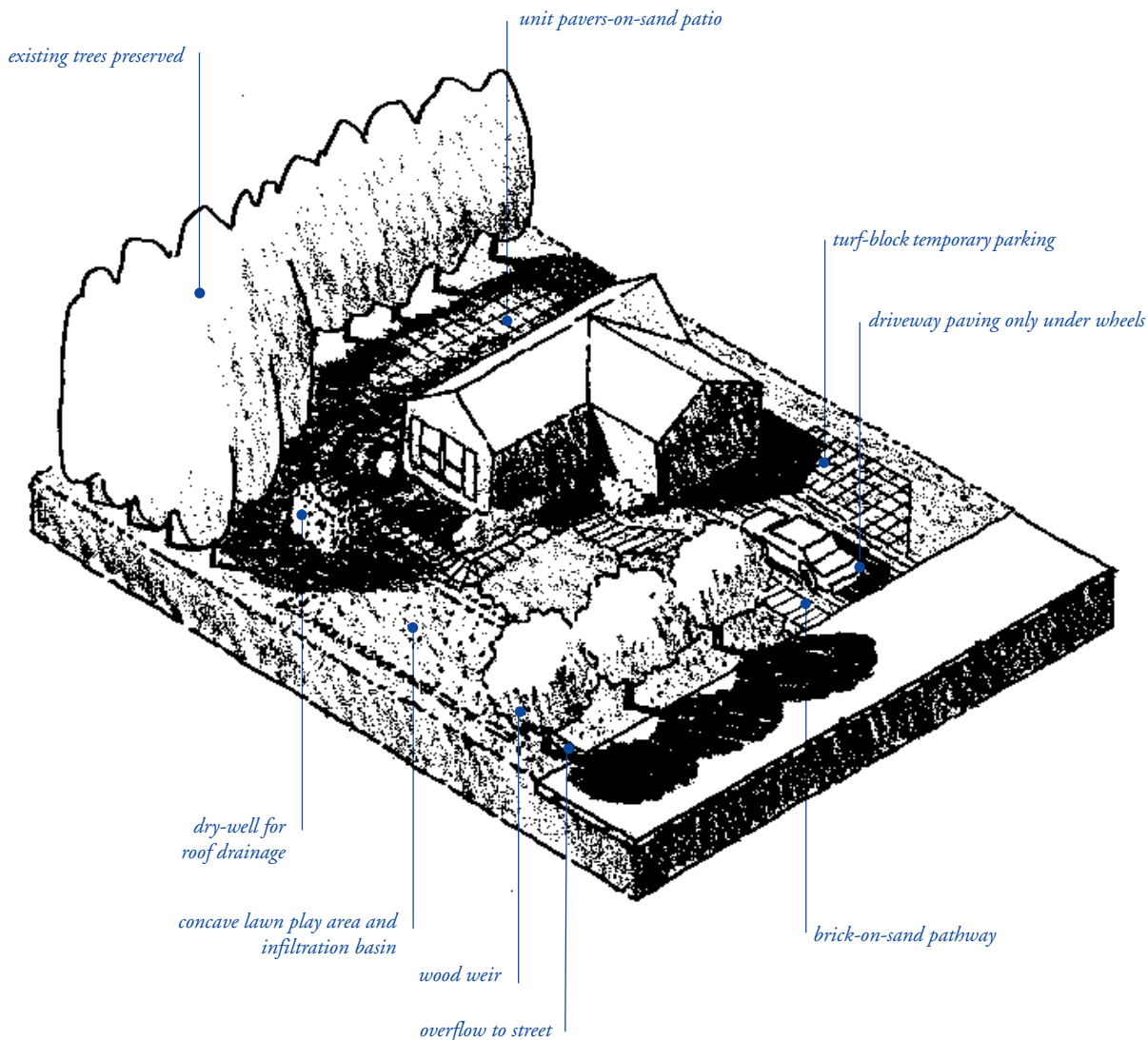

7.1b Large single lot. A large single-family home lot usually provides many opportunities for stormwater management. Because the ratio of impervious cover relative to land area is usually low, adequate landscape area is available to accommodate a variety of subtle infiltration strategies.

As with the small single lot, homeowner education is important so that residents understand the intent of various design elements, and their proper care. They especially need to understand the maintenance needs of more active elements, such as cisterns, which need periodic cleaning or emptying. If dry-wells are included, residents must also understand that they are for

rainwater only – never as a place to dump oil, pesticides, paint thinner, solvents, cleaners, degreasers, or other unwanted wastes.

The techniques illustrated in this example are:

- unit pavers-on-sand patio
- concave lawn play area and infiltration basin
- not directly connected impervious driveway
- brick-on-sand pathway
- dry-well connected to roof downspout
- cistern
- vegetation for water retention (deep rooted trees)
- vegetation at dripline of roof.

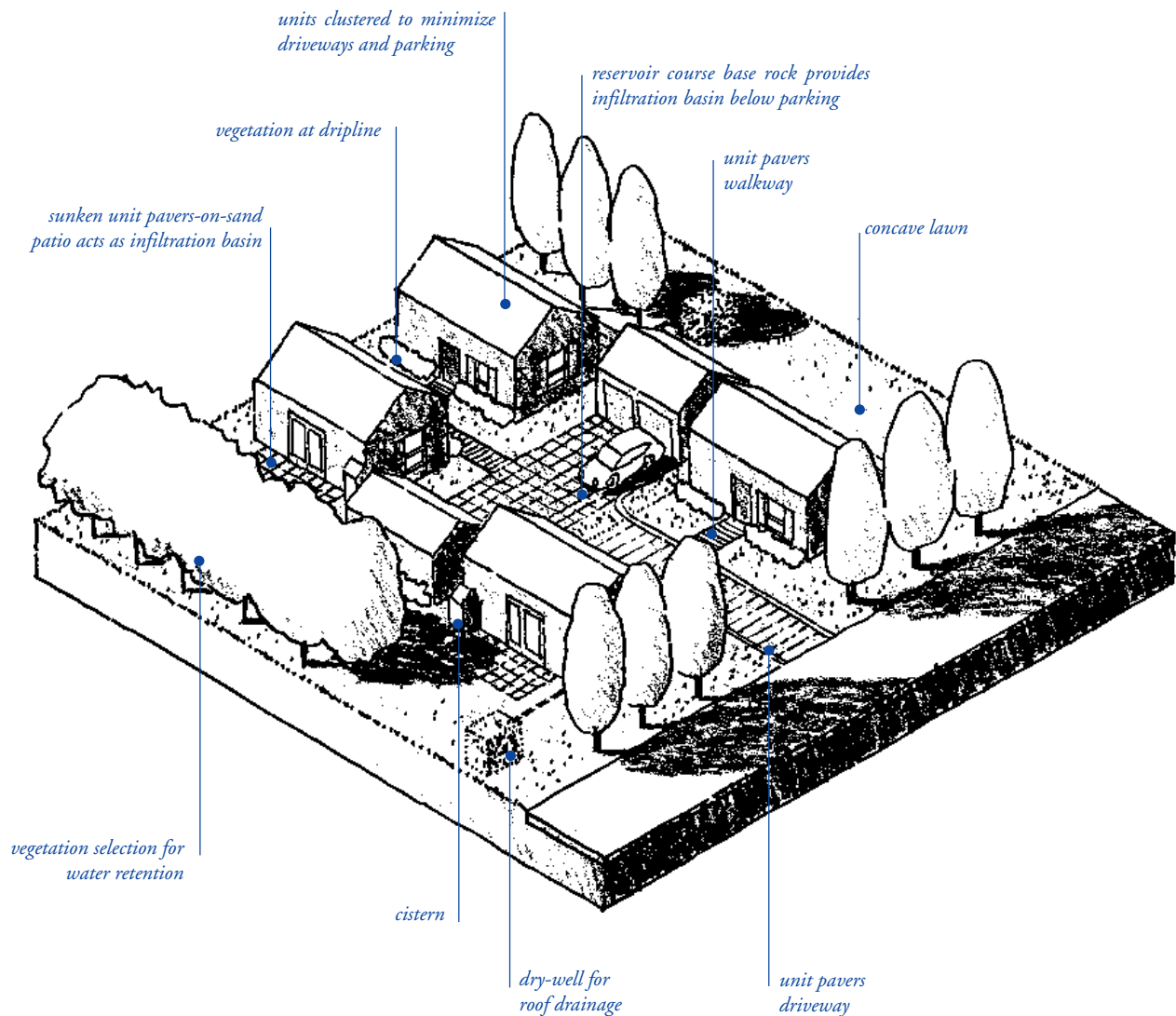
High density multi-family site

7.1c High density multi-family site. In the Bay Area, many of the sites for new construction are infill or redevelopment sites. These sites usually have higher densities (typically from 12 to 40 units per acre) which demands a greater proportion of pavement and roof coverage.

Opportunities for on-site stormwater management usually still exist, even in the most densely developed infill site, though they may require greater creativity or multiple use of space.

Continuous homeowner education is needed to prevent dumping. Hazardous waste disposal must be provided for used oil/solvents, cleaners, etc.

The techniques illustrated in this example are:

- unit pavers-on-sand patio
- concave lawn play area and infiltration basin
- not directly connected impervious driveway
- brick-on-sand pathway
- dry-well connected to roof downspout
- cistern
- vegetation for water retention (deep rooted trees)
- vegetation at dripline of roof.

Small hillside site

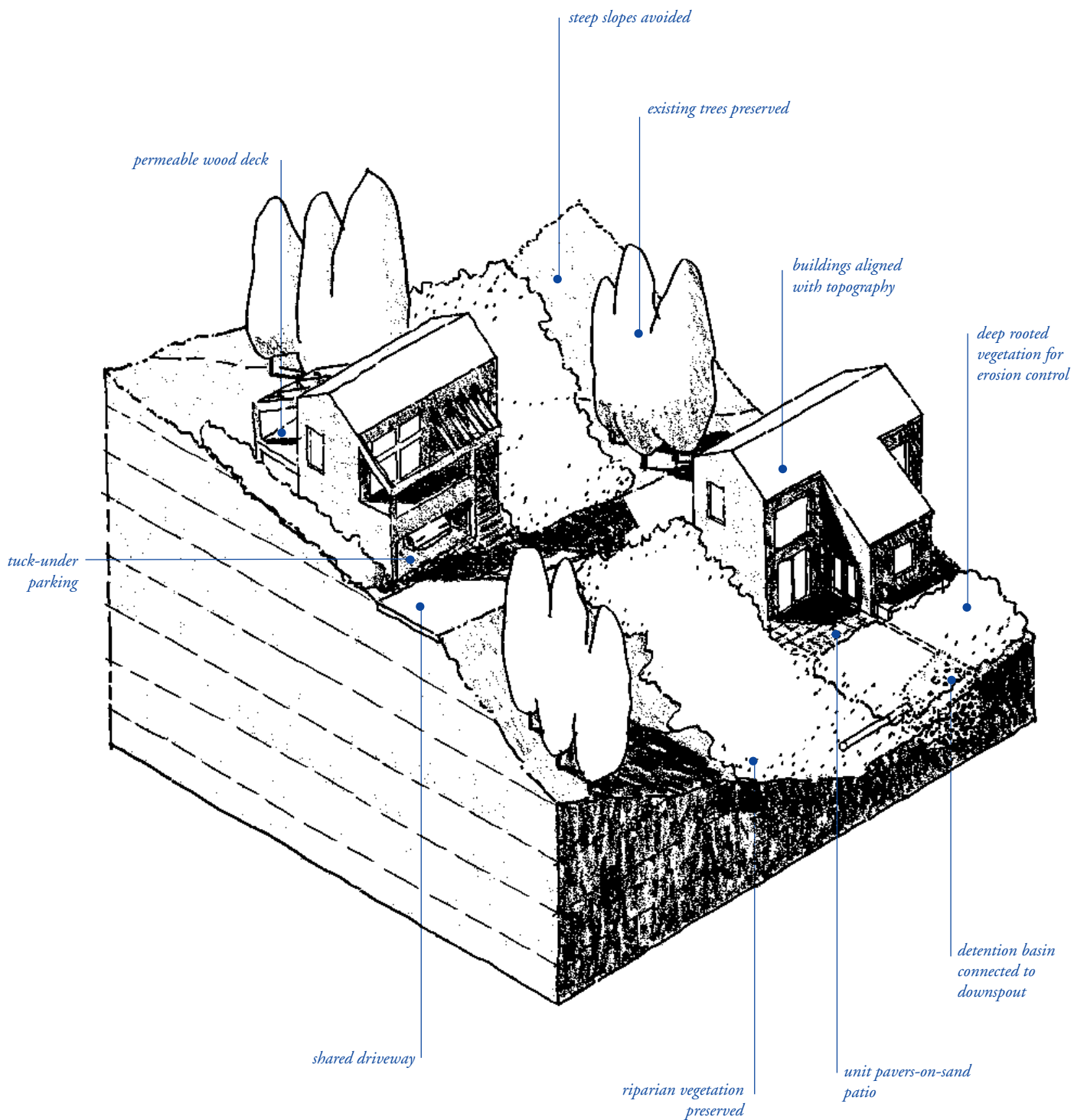

7.1d Small hillside site. Hillside sites present particular challenges for stormwater management. Because slopes are often pronounced, some infiltration strategies that are best suited to more level sites, such as dry wells or infiltration basins, are impractical and can cause landslides or severe damage. Erosion must be prevented through siting with contours to minimize grading and careful stabilization of disturbed slopes. Finally, drainage systems and detention devices must be located so that water does not compromise the integrity of building foundations and other structures.

The techniques illustrated in this example are:

- avoidance of steep slopes
- buildings aligned with topography to minimize grading
- preservation of existing trees
- preservation of riparian vegetation
- deep rooted vegetation for erosion control
- shared driveway
- tuck-under parking
- permeable wood deck for outdoor use area
- unit pavers-on-sand patio
- detention basin connected to roof downspout
(downslope from building)

Large hillside site

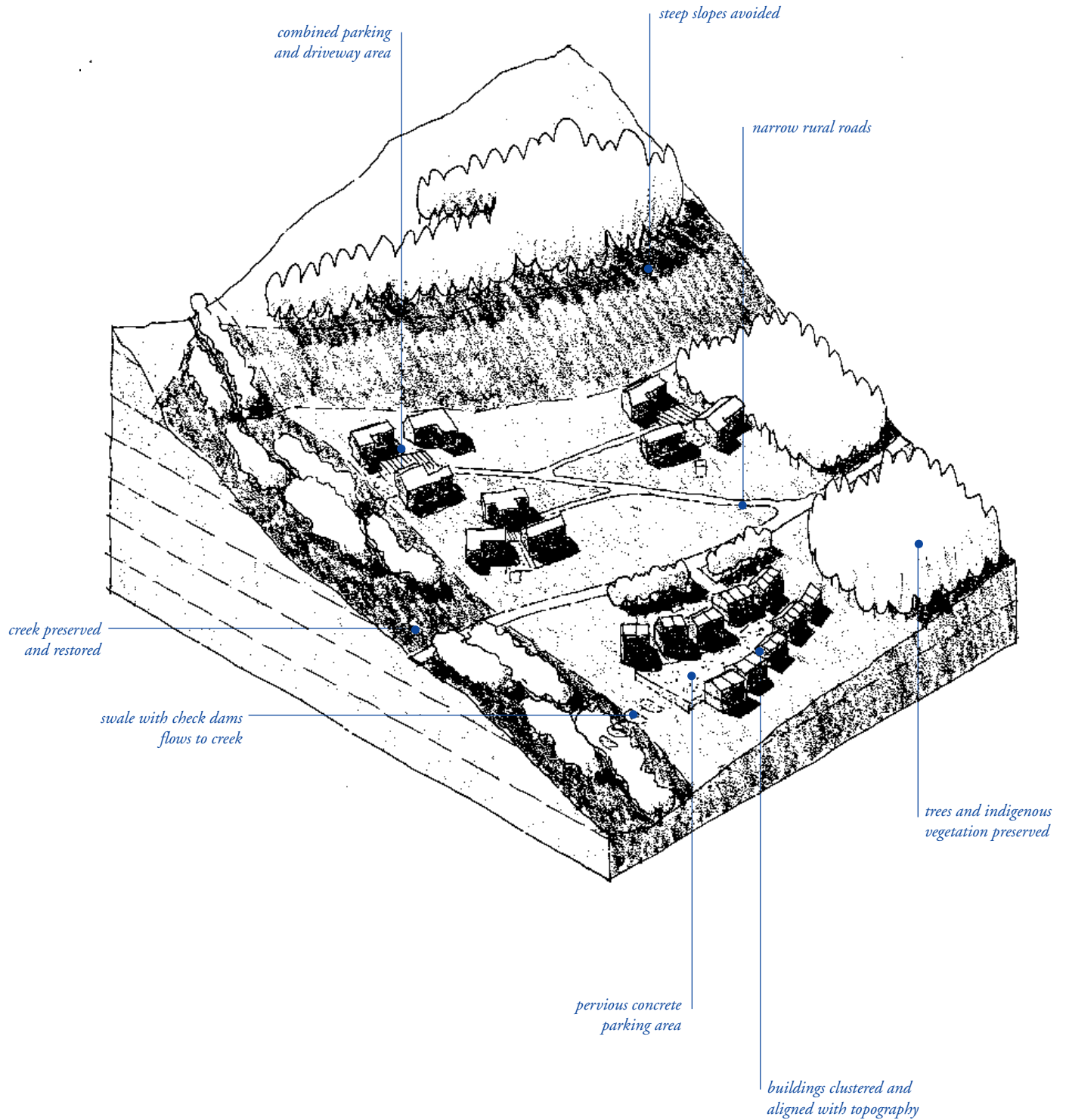

7.1e Large hillside site. Larger hillside sites present similar challenges as smaller sites, but sometimes offer more opportunities for stormwater management. Because slopes are often pronounced, some infiltration strategies that are best suited to more level sites are impractical and may cause landslides. Erosion must be prevented through siting with contours to minimize grading and careful stabilization of disturbed slopes. Finally, drainage systems, infiltration basins and detention devices must be located so that water does not compromise the integrity of building foundations and other structures.

This example shows a large scale application of the site planning and design principles discussed earlier. Each cluster of buildings could also contain the finer grain elements like those illustrated for the small hillside site (7.1d).

The techniques illustrated in this example are:

- avoidance of steep slopes
- buildings clustered and aligned with topography
- preservation of existing trees and indigenous vegetation
- creek preserved and restored
- narrow rural roads
- combination parking and driveway area
- pervious concrete parking area
- swale with check dams flows to creek

Large flat site

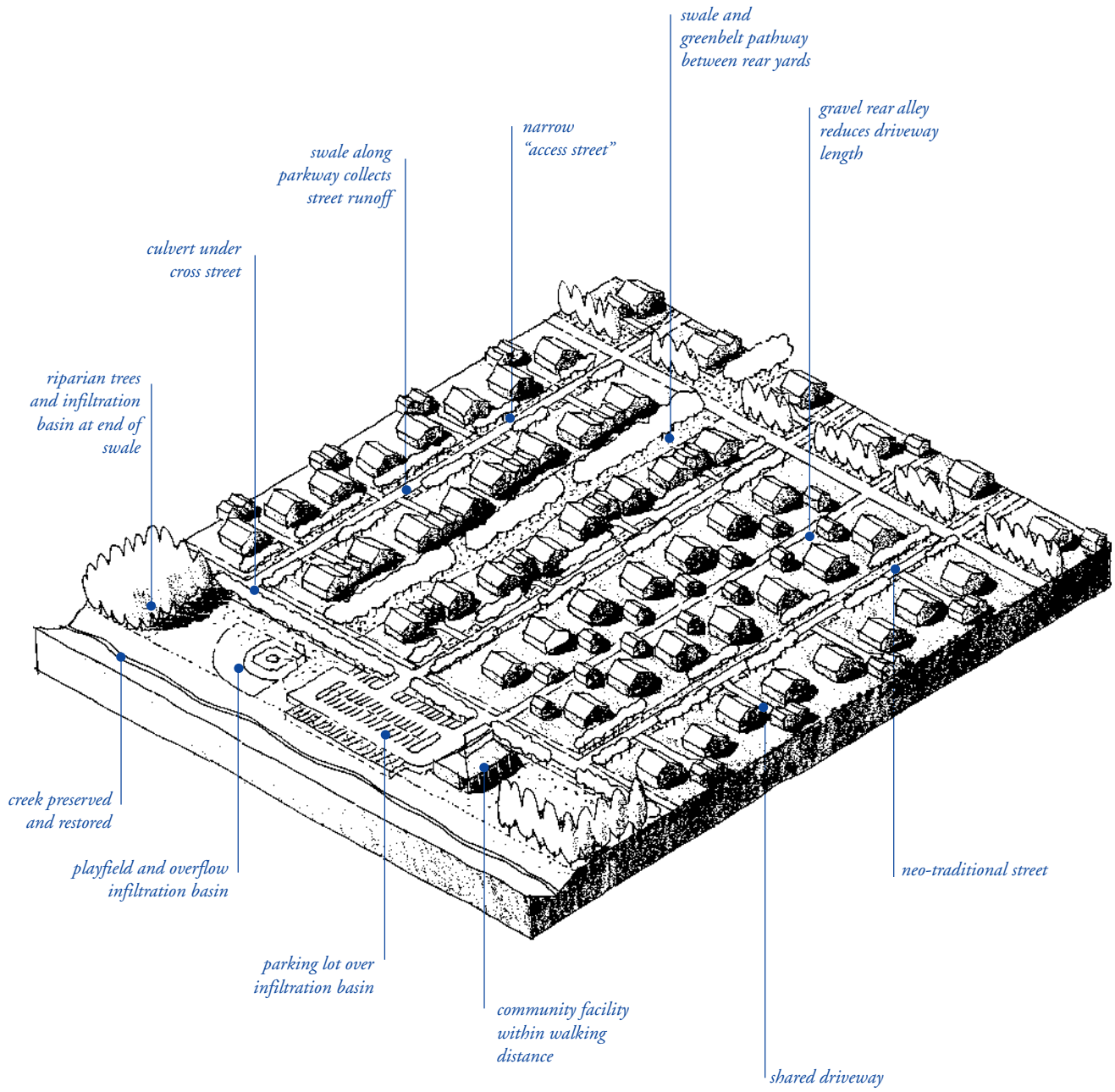

7.1f Large flat site. Larger flat sites present some of the greatest opportunities for stormwater management. If soils have adequate percolation rates, infiltration swales and basins are easily incorporated. In more poorly drained soils, flat sites allow for detention and retention systems to slow the speed of runoff and hold it for later release. This allows sediments to settle and minimizes stream bank erosion from high velocity flows.

This example applies the site planning and design principles discussed earlier at the neighborhood scale. For the purposes of illustration, two different street access systems are shown: driveways from the street or rear alley access. Each has different planning implications, but both can be integrated with appropriate stormwater management.

Each cluster of buildings could also contain the finer grain elements like those illustrated for the small single lot, large single lot and infill site.

The techniques illustrated in this example are:

- neo-traditional street design
- gravel rear alley reduces driveway length
- shared driveways to minimize pavement
- community facility within walking distance
- parking lot over infiltration basin
- depressed playfield with multiple use as infiltration basin
- swale along parkway collects street runoff
- culvert to carry parkway swale under cross street
- riparian trees and infiltration basin at end of swale
- swale and greenbelt pathway between rear yards

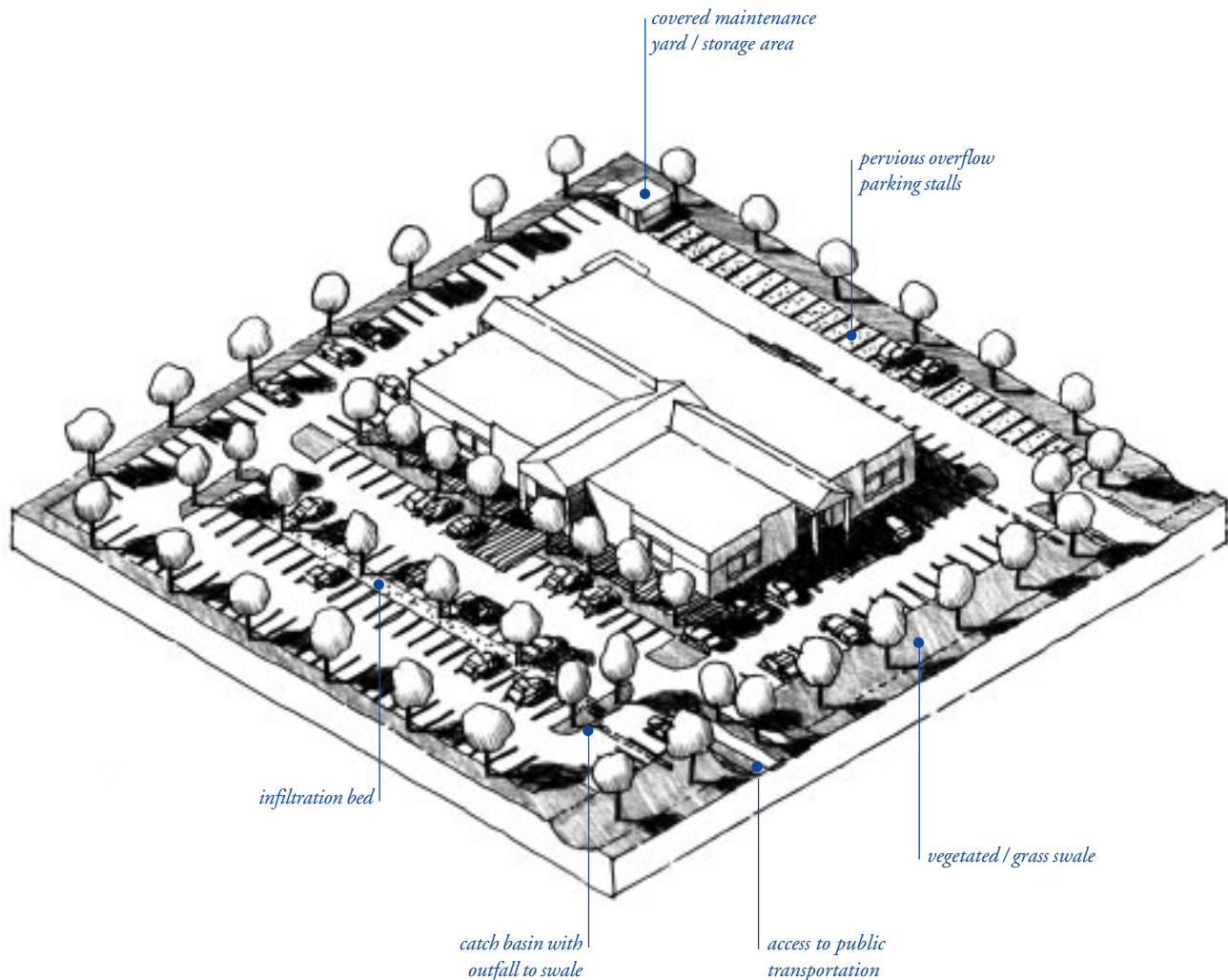
Shopping center

7.2a Shopping center. Shopping centers present many opportunities for stormwater management, especially in the parking areas. Infiltration swales and extended detention (dry) basins can be incorporated into space between parking aisles. Recognizing that much of the parking is only necessary during peak times, such as the holiday season, a proportion of outlying stalls may be paved with a more permeable pavement such as crushed aggregate or turfblock .

The utility functions inherent in any shopping center also need attention, such as restaurant wash-down areas, trash collection areas, and service yards. These outdoor work areas require specific techniques to prevent polluted runoff from entering the storm drain system or local water bodies. Similarly, potential

hazardous materials use within the shopping center, i.e. dry cleaning establishments, requires special attention and treatment.

If well designed, correctly installed, and properly maintained, stormwater management techniques can enhance the aesthetic character of a shopping center and improve its marketability.

The techniques illustrated in this example are:

- vegetated/grass swale along perimeter
- infiltration bed to divide parking aisles
- pervious overflow parking stalls
- public transportation service
- covered maintenance yard/service areas

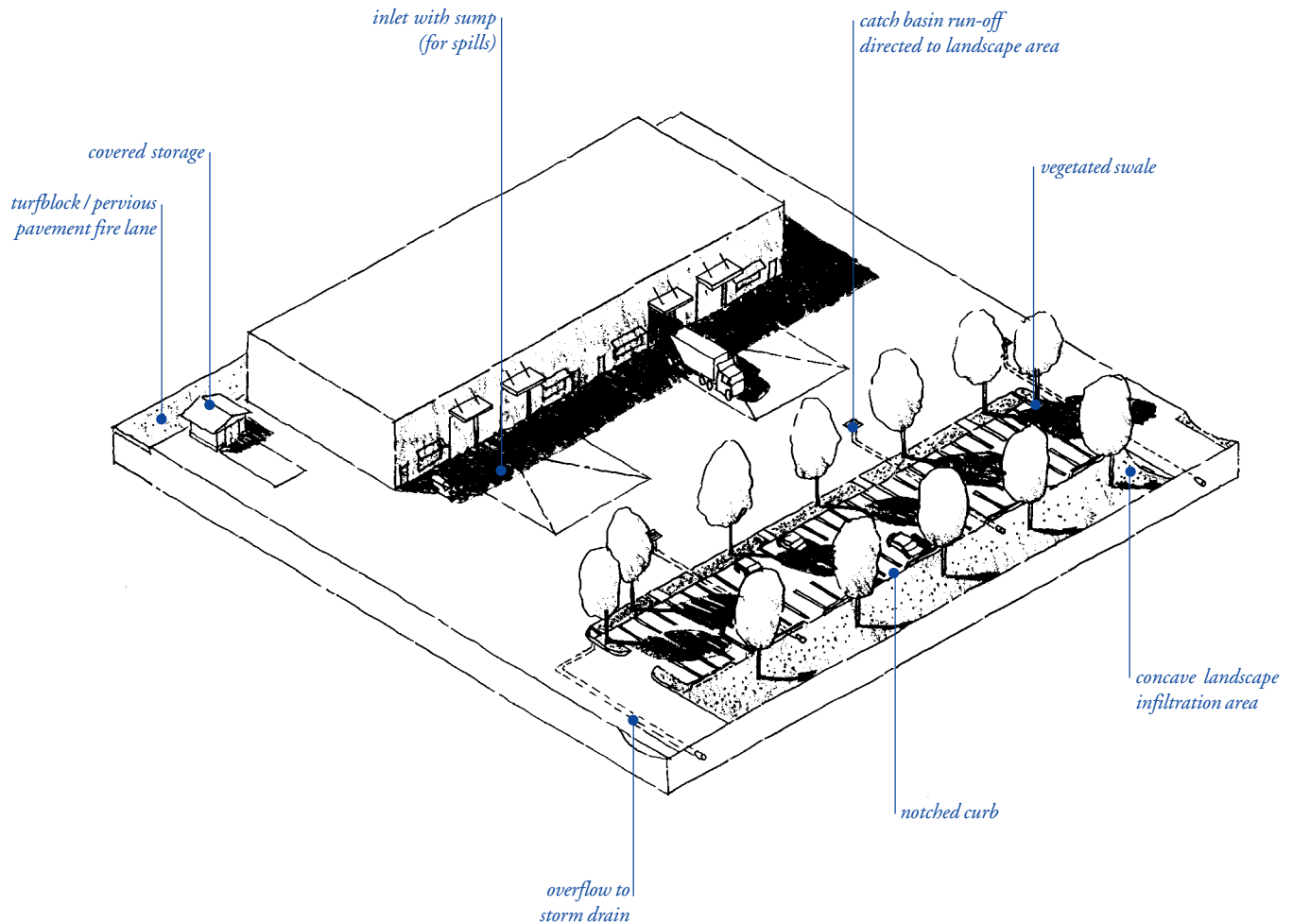

7.2b Industrial park. Industrial parks present special challenges when designing for stormwater management. They usually require large paved areas for truck access and employee parking, and space is usually limited. They also often have chemical storage and other special activity areas that require that infiltration techniques are avoided.

Still, there are opportunities to incorporate design details to protect stormwater quality. These include minimizing impervious surface area through the use of permeable pavements, infiltration areas to collect runoff, and proper treatment of special activity areas.

The techniques illustrated in this example are:

- vegetated/grass swale along perimeter
- catch basin runoff directed to infiltration area
- permeable pavement fire lane
- notched curb to direct runoff from parking area into swale
- proper loading dock design
- covered maintenance yard/service areas

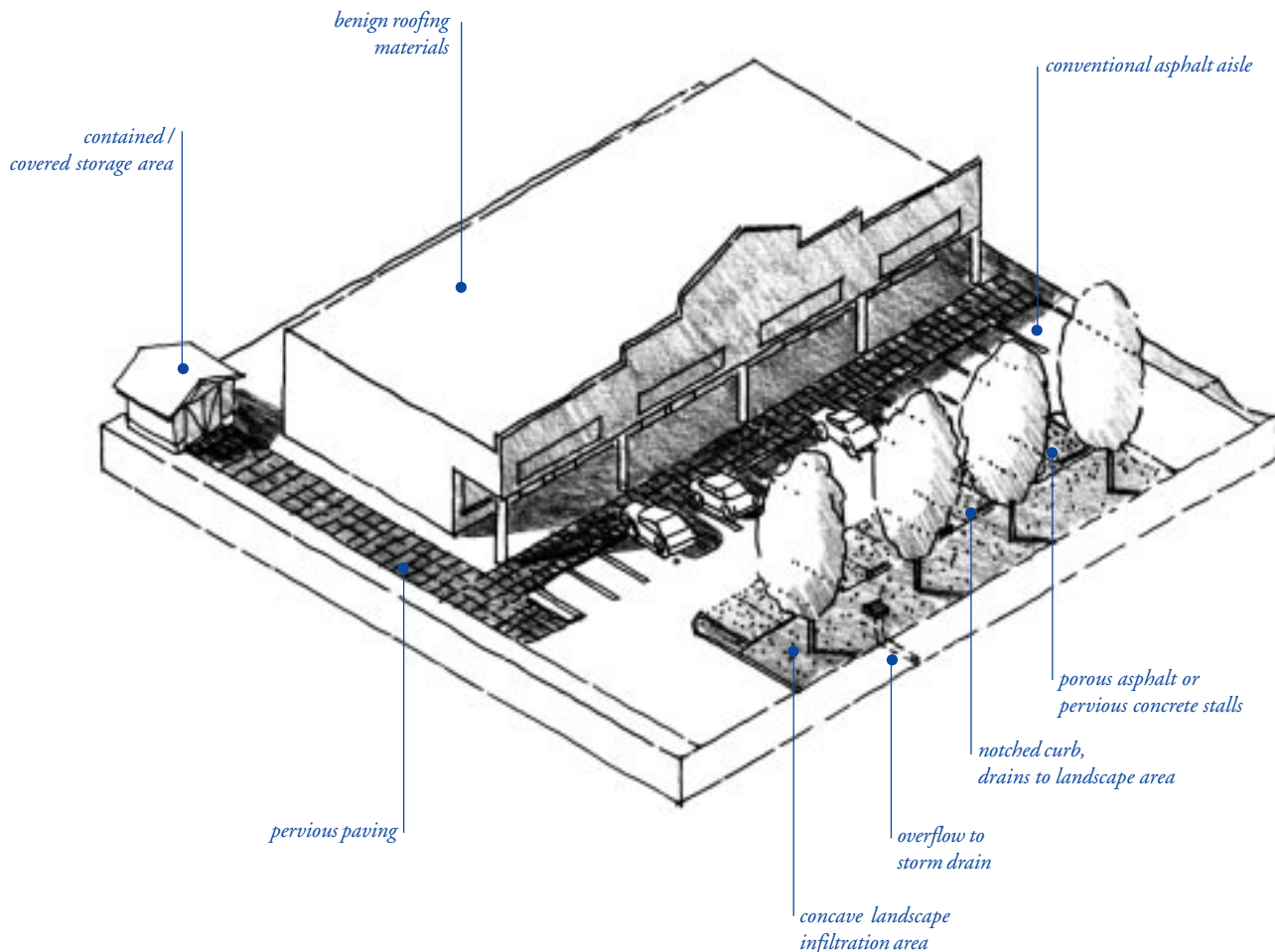
Strip Mall

7.2c Strip Mall. Though strip malls are usually very densely developed, they present opportunities for stormwater management techniques. These can be implemented without changing the normal aesthetics or function.

Parking areas can be paved in porous asphalt or other permeable pavements. Buildings can be constructed from benign materials, and the landscape buffers, usually required by local jurisdictions, can be designed as infiltration areas with appropriate overflow into the storm drain system.

Finally, trash and other storage areas can be properly designed and constructed to prevent pollutants from running off these areas into the storm drain system.

The techniques illustrated in this example are:

- benign roofing materials
- catch basin runoff directed to infiltration area
- permeable pavement parking stalls
- concave landscape areas to infiltrate runoff
- notched curb to direct runoff from parking area into swale
- covered maintenance yard/service areas

Schools and parks

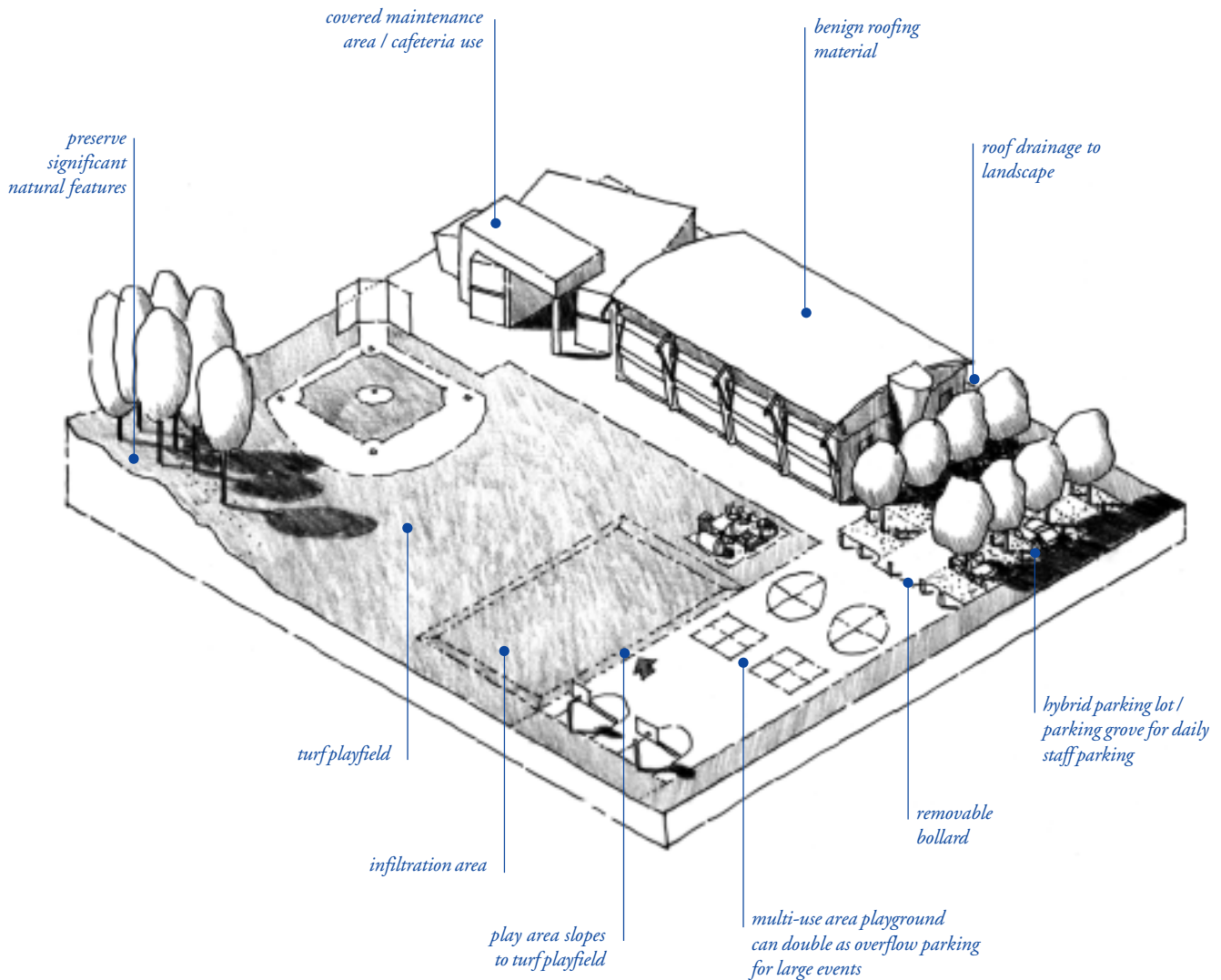

7.2d Schools and parks. Schools and parks present a wide range of opportunities for stormwater management techniques. Large landscape areas for passive and active recreation can be designed as extended detention (dry) ponds to infiltrate and detain runoff, while drying up shortly after rains.

At schools, staff parking can be located in parking groves, since the teaching staff generally parks for long periods. Paved areas, such as basketball courts, can be designed as parking or other multi-use space for special events, thus reducing the need for additional impervious land coverage. Buildings can be designed from benign building materials with appropriately designed outdoor work areas for service, cafeteria, and utility needs.

In large subdivisions, land is often reserved for future schools and parks. Land can be reserved in the lower portion of the site for these uses and designed to receive stormwater from the entire subdivision watershed. This approach illustrates how stormwater management can influence overall site planning and design.

The techniques illustrated in this example are:

- benign roofings materials
- catch basin runoff directed to infiltration area
- parking grove for staff use
- multi-use paved areas
- concave landscape areas to infiltrate runoff
- preservation of significant natural areas
- covered maintenance yard/service areas

Office building

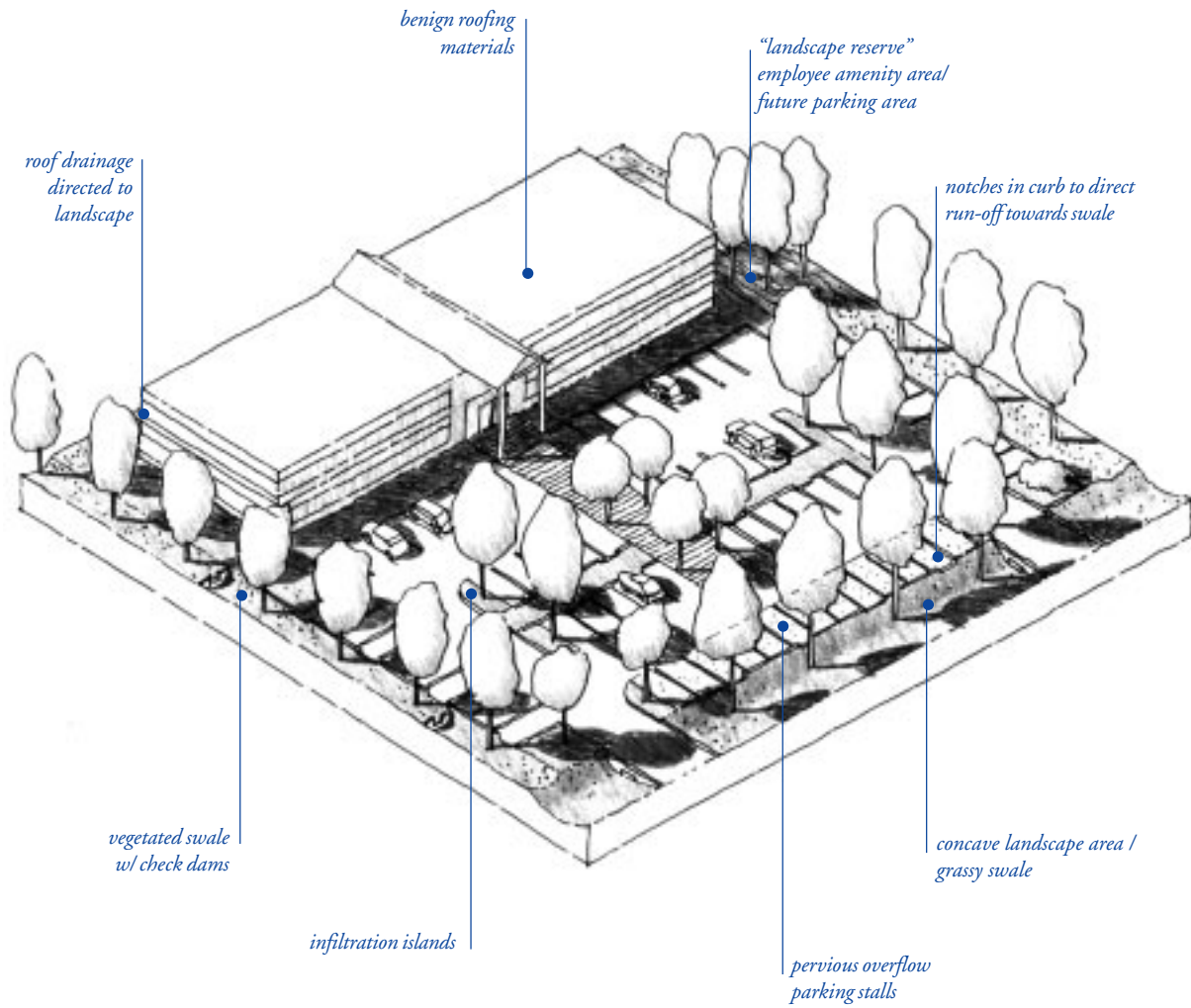

7.2e Office buildings. Office buildings can integrate stormwater management techniques in many ways.

Buildings can be designed from benign materials with appropriately designed outdoor work areas for service, cafeteria, and utility needs.

Landscape areas for employee use and perimeter screening can be designed as extended detention (dry) basins or biofilters (grassy swales) to infiltrate and detain runoff, while drying up shortly after rains. These areas can also be designed as fountains or entry statements to add aesthetic enhancement .

Parking can be treated in a variety of ways, with overflow parking accommodated on permeable pavement. Impervious parking stalls can be designed to drain onto landscape infiltration areas. Alternative transportation can be promoted by providing bicycle lockers, showers and clothes lockers for bicycle commuters, and company sponsored van- and carpool programs.

Finally, many jurisdictions allow a portion of the required parking to be held in “landscape reserve,” until a need for the full parking supply is established. This means that the original construction only builds parking to meet anticipated staff needs. If the parking demand increases, the area held in landscape reserve can be modified to accommodate parking. In this way, parking is held to a minimum based on actual use, rather than by a zoning formula that may not apply to the office building’s actual parking need.

The techniques illustrated in this example are:

- benign building materials
- catch basin runoff directed to infiltration area
- vegetated swale with check dams
- landscaped “parking reserve”
- concave landscape areas to infiltrate runoff
- pervious overflow parking stalls
- roof drainage directed to landscape

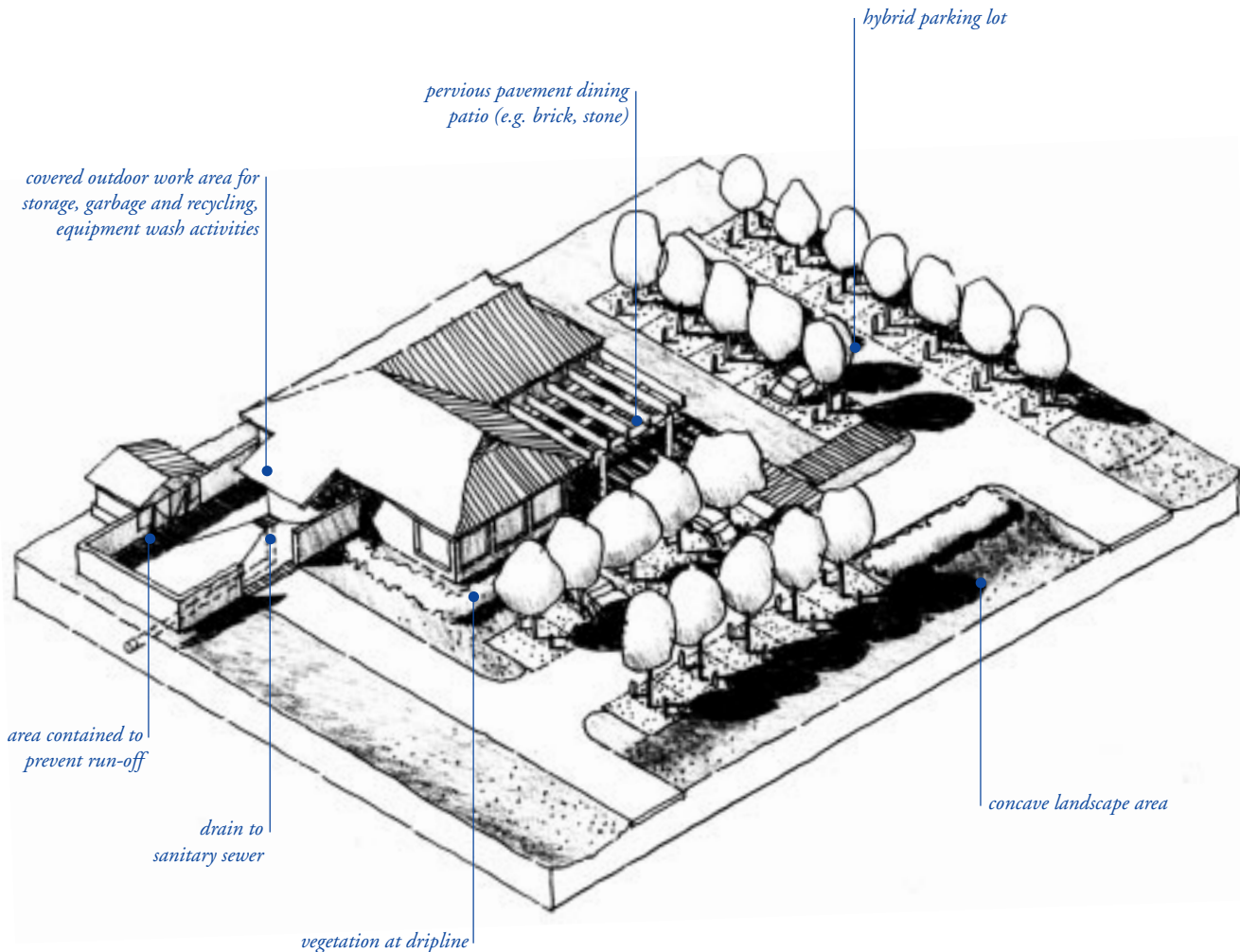

7.2f Restaurant. Restaurants offer a strong contrast between infiltration opportunities and special activity areas. Careful selection of materials such as brick or stone paving for outdoor patios can enhance the restaurant's aesthetic while allowing for infiltration. Landscape plantings can also be selected for stormwater infiltration.

Parking can be provided in a variety of ways, with hybrid parking lots for staff, who stay for long shifts, or with landscaped infiltration islands in lots with conventional paving for patrons, who stay for shorter periods.

In contrast to these infiltration opportunities, restaurants have special activity areas that need to be isolated from the storm

drain system. Grease, stored items, trash, and other food waste must be kept in properly designed and maintained special activity areas. Local ordinances may have design guidelines for allowable square footage of covered and uncovered areas.

The techniques illustrated in this example are:

- permeable pavement patio
- benign building materials
- catch basin runoff directed to infiltration area
- hybrid parking lot
- vegetation at dripline
- concave landscape areas to infiltrate runoff
- covered outdoor work area (trash, food waste, storage, equipment wash)

Gas station

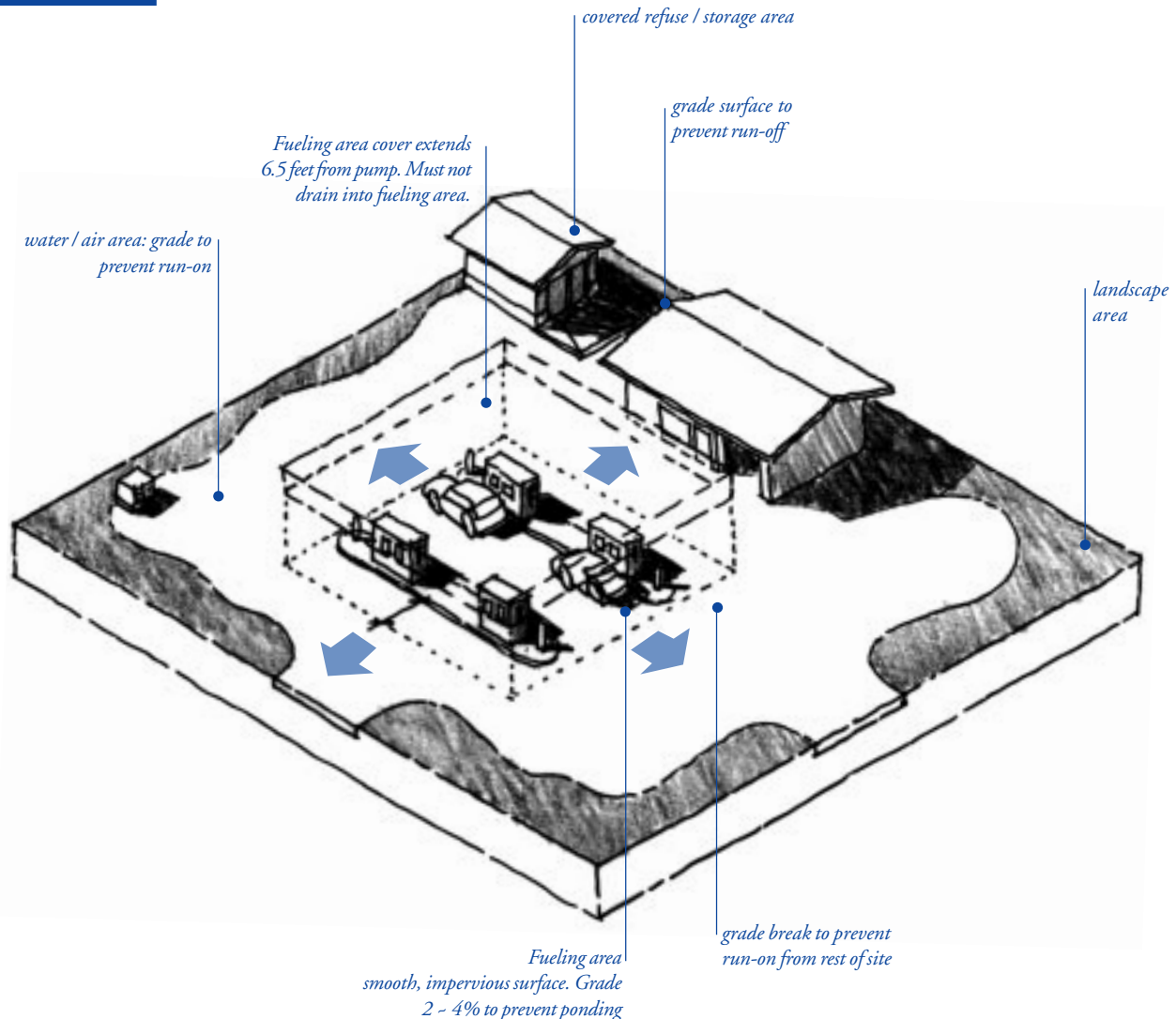

7.2g Gas station. Gas stations and vehicle fueling areas have specific design guidelines. These are described in a Best Management Practice Guide for retail gasoline outlets developed by the California Stormwater Quality Task Force, in cooperation with major gasoline corporations. Designing for prevention is the first step. Plans must be developed for cleaning near fuel dispensers, emergency spill cleanup, and routine inspections to prevent leaks and ensure properly functioning equipment.¹

The practice guide addresses standards for existing, new, or substantially remodeled facilities, and is available from www.blymyer.com/swqtf.

Some of these features are illustrated in the case study above:

- fueling area cover
- flat impervious surface fueling area (2%-4% slope to prevent ponding,
- grade break (e.g., curb, berm) that prevents run-on of stormwater
- separate water / air area graded to prevent run-on
- covered refuse / storage area

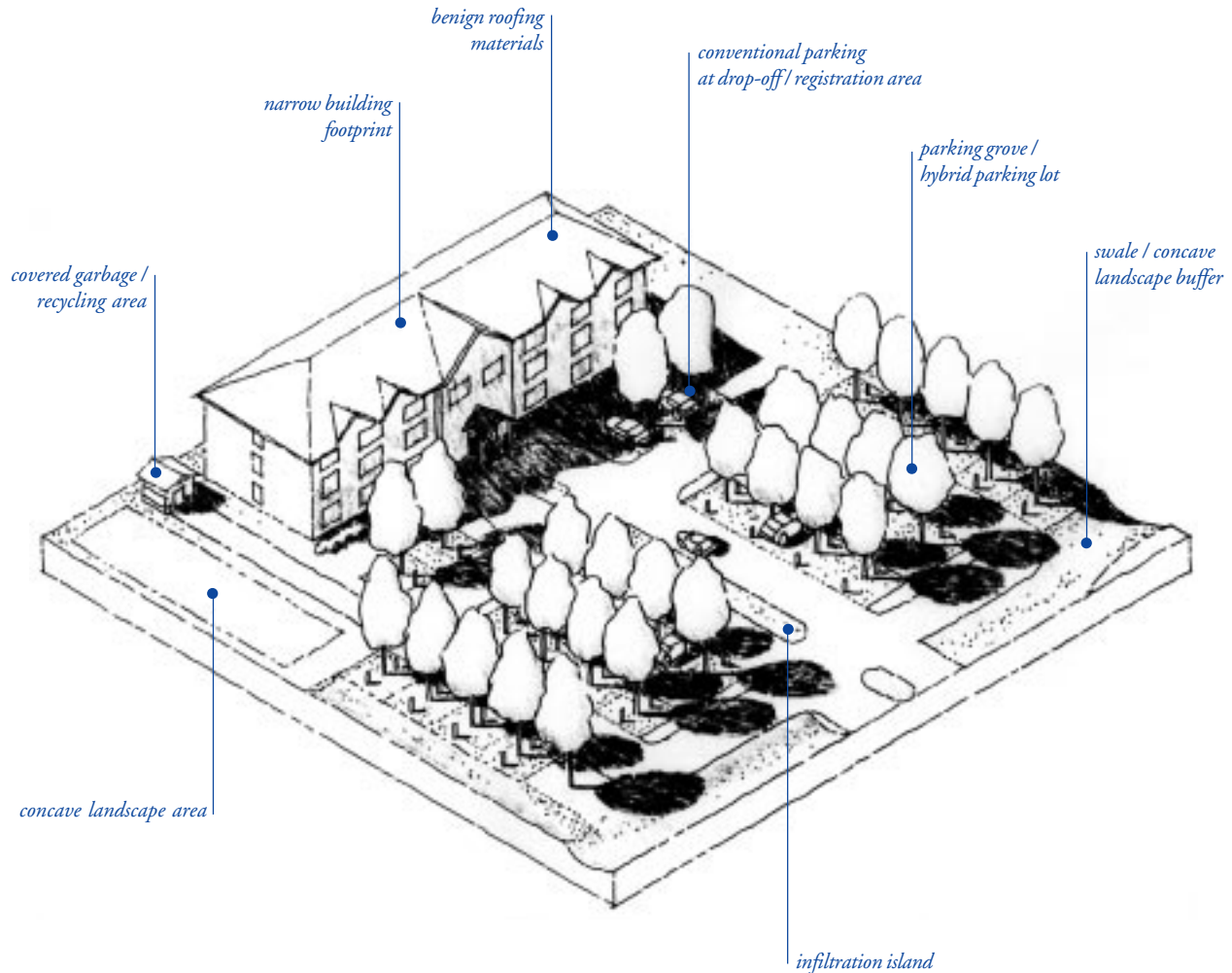

7.2h Hotel/motel. Hotels and motels present many opportunities for stormwater management designs. Because guests park for long periods of time, such as overnight, parking areas can be designed as parking groves or hybrid lots. This increases the aesthetic appeal of the hotel, reduces heat island effect, and minimizes the impact of parking when the hotel is not highly occupied. However, it is important to retain some conventional parking for more heavily used drop-off and loading areas.

Landscape areas for guest use can be designed as infiltration/detention areas to hold water briefly after rains. Perimeter areas also can provide opportunities for stormwater management.

The building can be designed from benign materials with a narrow multistory footprint, rather than a sprawling single floor. Rainwater can be directed in gutters and downspouts into landscape areas.

The techniques illustrated in this example are:

- permeable pavement patio
- benign building materials, narrow building footprint
- catch basin runoff directed to infiltration area
- parking grove
- vegetation at dripline
- concave landscape areas to infiltrate runoff
- covered special activity area (trash, food waste, storage)

8 Technical Section

The site design and landscape details illustrated here have two purposes:

- *to minimize the creation of new runoff, and,*
- *to infiltrate or detain runoff in the landscape.*

The techniques presented here illustrate an approach to design and construction for maximizing infiltration, providing retention, slowing runoff, and minimizing impervious land coverage. They are not all-inclusive, and may not be appropriate for every site or condition. Each detail is given in a generic or typical form— particular site and soil conditions must be assessed by a qualified professional to determine which details are appropriate and what modifications are required for their proper application.

Technical Section

- 8.1 Permeable pavements**
- 8.2 Streets**
- 8.3 Parking lots**
- 8.4 Driveways**
- 8.5 Buildings**
- 8.6 Landscape**

8.1 Permeable Pavements

Permeable pavements are a method of reducing impervious land coverage while simultaneously providing a stable load-bearing surface. While forming a surface suitable for walking and driving, permeable pavements also contain sufficient void space to infiltrate runoff into soil. By making pavements permeable, impervious surface coverage can be reduced without sacrificing intensity of use.

There are three main categories of permeable pavements: poured-in-place, unit pavers-on-sand, and granular materials. A typical component of these permeable pavements is a reservoir base course. This base course provides a stable load-bearing surface as well as an underground reservoir for water storage. The base course must meet two requirements:

- it must be open graded, meaning that the particles are of a limited size range, with no fines, so that small particles do not choke the voids between large particles. Open-graded crushed stone of all sizes has a 38 to 40% void space, allowing for substantial subsurface water storage.
- it must be crushed stone, not rounded river gravel. Rounded river gravel will tend to rotate under pressure, causing the surface structure to deform. The angular sides of the crushed stone will form an interlocking matrix, keeping the surface stable.

Permeable pavements must be laid on a relatively flat slope, generally 5% or flatter. If permeable pavements are laid on steep slopes, the underlying base course tends to migrate downhill, causing the surface to deform.

Permeable Pavements

Pervious concrete
Porous asphalt
Turf block
Brick
Natural stone
Unit pavers on sand
Crushed aggregate (gravel)
Cobbles

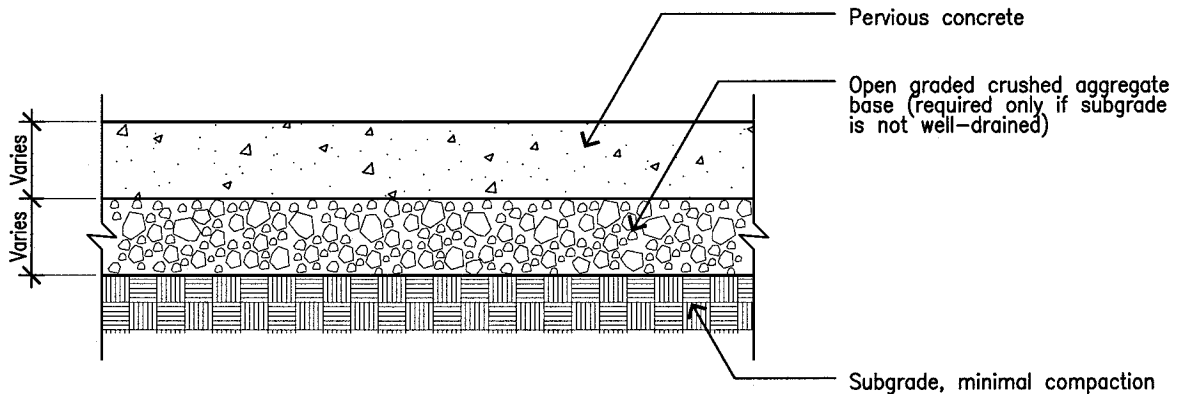

Conditions, dimensions, and materials shown are typical. Modifications may be required for proper application, consult qualified professional.

Pervious Concrete is a discontinuous mixture of coarse aggregate, hydraulic cement, and other cementitious materials, admixtures, and water, which has a surface-void content of 15-25%, allowing water and air to pass through the pavement.

Characteristics

- Rigid, poured-in-place slab.
- Appearance similar to exposed aggregate.
- Curb and gutter system may not be necessary to control low flow.
- Runoff coefficient: very low to nil (can infiltrate up to 140 cm/h [56"/h]).
- Reduces impervious land coverage.

Applications

- Flat sites (slope \leq 5%) with uniform, permeable subgrade (or appropriate depth to construct deep base).
- Low traffic volume bikeways, streets, travel lanes, parking stalls, residential driveways, patios.

- Not appropriate for gas stations, truck stops, areas in which high concentrations of hydrocarbons can be leached into the soil.

Design

- Subgrade and base rock design must be determined by a qualified professional according to soil conditions and intended use or anticipated loads.
- Subgrade must be uniform, well-drained (infiltration rate \geq 5"/hr). Top 6" of subgrade should be granular/gravelly soil, predominantly sandy, with low to moderate amount of clay or silt.
- Base of open graded, crushed (not rounded) stone, no fines. Must be designed to support surface uses, allow water to flow through, and prevent migration of subbase soils.
- Special attention and tools required for installation.

Maintenance

- Inspect for clogging after installation and annually; remove spot clogs.
- Some installers recommend quarterly vacuum sweeping or high pressure hosing.
- Maintenance can be high first few years, until site is fully stabilized.

Economics

- Installation costs up to 50% greater than conventional concrete.
- Costs can be offset by savings in not installing curb and gutter drainage system.
- Maintenance cost up to 1-2% of construction cost annually.

Examples/resources

- Drain cover at Stanford Shopping Center, Palo Alto, CA.
- Tree grates in city sidewalks, Los Angeles, CA.
- Florida Concrete and Products Association (407) 423-8279.

Porous asphalt

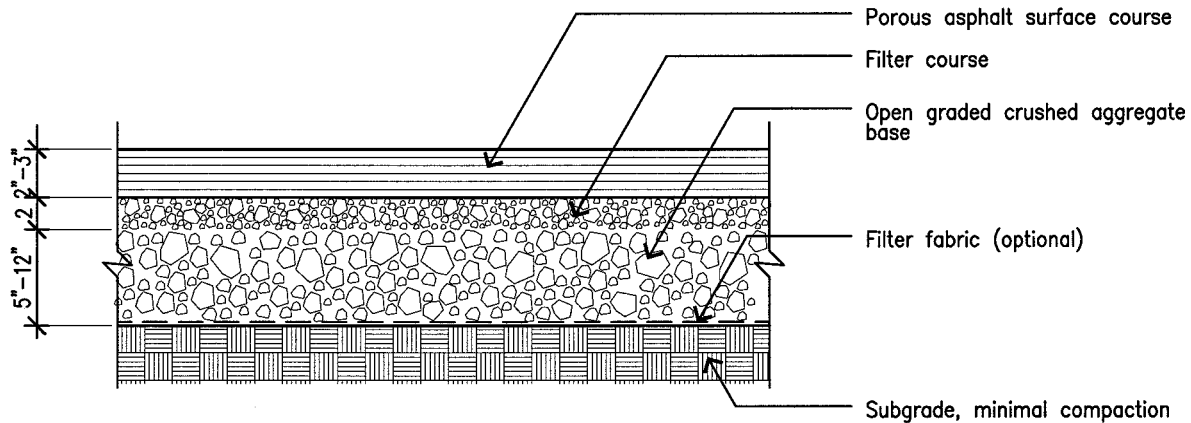

Conditions, dimensions, and materials shown are typical. Modifications may be required for proper application, consult qualified professional.

Porous Asphalt is an open graded asphalt concrete over an open graded aggregate base and a draining soil. It is composed almost entirely of stone aggregate and an asphalt binder. Porous asphalt is widely used as a top lift on state highways to minimize water ponding and hydroplaning. In this case it does not create a permeable pavement, because the porous (“open graded”) asphalt is laid over a conventional asphalt lift.

Characteristics

- Flexible, poured-in-place slab.
- Appearance similar to conventional asphalt, though rougher surface.
- Rough, coarse surface improves traction in wet conditions, but may result in a rough ride.

- Curb and gutter system may not be necessary to control low flow.
- Runoff coefficient: very low to nil (can infiltrate 50-150 cm/h [20-60"/h])
- Reduces impervious land coverage.

Applications

- For use in areas with low traffic use, such as parking lots, travel lanes, parking stalls (surface may be too rough for bicycle path).
- Flat sites (slope ≤ 5%) with uniform, permeable subgrade (or appropriate depth to construct deep base).
- Not appropriate for gas stations, truck stops, areas in which hydrocarbons can be leached into the soil.

- May not be appropriate in areas where children are at play (pavement may cause abrasion injuries).

Design

Asphalt mix void content of 12 - 20%.

Surface composition 4.5 - 6.5% asphalt aggregate, 2.5 - 3.0% asphaltic cement.

Base composition 5" to 12" depth open graded crushed (not rounded) 1/2 - 1" stone, having infiltration rate ≥ 5" per hour.

- Filter fabric may be required below base course.

Subgrade and base rock design must be determined by a qualified professional according to soil conditions and intended use or anticipated loads.

- Special tools required for installation.

Maintenance

- Most failures occur when substantial quantities of sediment erode onto pavement surface. This can happen if pavement is located downhill from an erosive and sediment is allowed to wash over the surface, or during construction due to a lack of erosion/sediment control measures. Void spaces then become clogged, either requiring wet-vacuuming or reducing the permeability of the surface.
- Some installers recommend quarterly vacuum sweeping and high pressure hosing, though installations are known that have had no special maintenance and remain permeable for 20 years.

- Inspect for clogging after installation and annually; remove spot clogs.
- Take measures to ensure that future property managers do not use top-coat or slurry seal, as this will clog the asphalt pores.

Economics

- Up to 50% more than conventional asphalt pavement.
- Costs can be offset by savings in reducing or eliminating curb and gutter drainage system.
- Maintenance cost up to 1-2% of construction cost annually.

Examples/resources

- Asphalt Institute (805) 373-5130.
- Metropolitan Transportation Commission, pavement management div. (510) 464-7700.
- CalTrans Specifications, Section 39, Asphalt Concrete “Open Graded” type.

Turf block

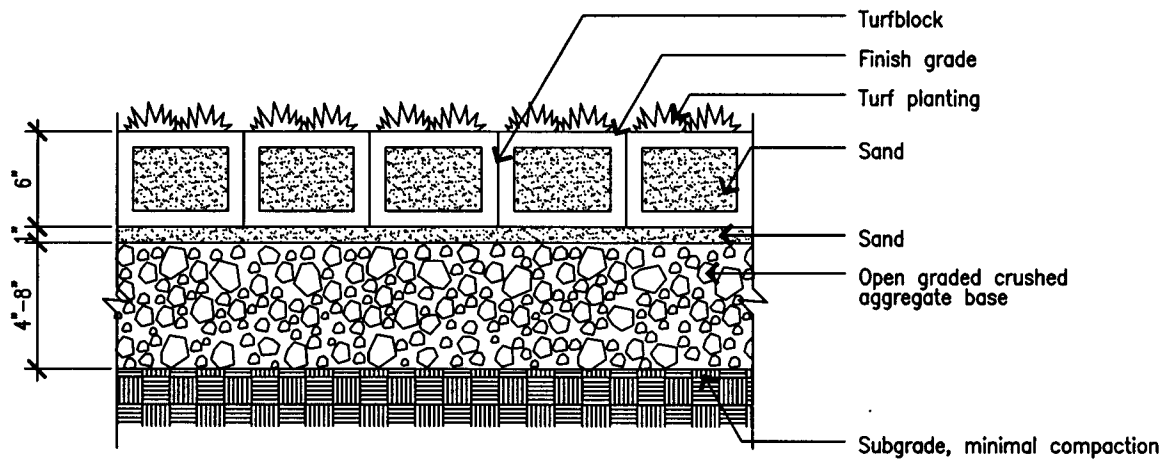

Conditions, dimensions, and materials shown are typical. Modifications may be required for proper application, consults qualified professional.

Turf block is an open-celled unit paver in which the cells are filled with soil and planted with turf. Sometimes the cells are filled with crushed rock only.

Characteristics

- Units vary in size, weight, surface characteristics, strength, durability, proportion of open area, interlocking capability, runoff characteristics, and cost.
- Original turf block was made solely of concrete, newer plastic styles are available. Concrete block is bulkier, with smaller openings for soil and infiltration. The concrete draws the moisture out of the soil, tending to dry out the grass in hot, dry weather. Plastic open-celled pavers eliminate this problem and have a greater void/soil space.
- Requires deep rooted grass species that can penetrate reservoir base course. Frequent watering may be required because the bulk of root and soil mass are located in the top 3"-4".
- Curbs and gutters generally not necessary to control low flow.

- Runoff coefficient: similar to grass, 0.15-0.60.
- Permeability is directly related to the permeability of the subgrade.
- Reduces impervious land coverage.

Applications

- Areas of low flow traffic and infrequent parking such as: residential driveways, overflow parking areas, the outer 1/3 of commercial and retail developments where parking space is used less often and for shorter periods of time, fire/emergency access roads, utility roads, street shoulders.
- Not suitable for all day parking, heavy use or areas with turning movements because the grass gets insufficient sun for optimal growth, or is suppressed by constant abrasion.
- Swales in urban areas. Turf block prevents mowers from getting stuck or creating grooves in the swale.

Design

- Flat sites (slope ≤ 5%)

- Base course: open-graded and composed of crushed rock (not rounded).
- Subgrade must be designed for anticipated loads.
- Provide underdrain system where there are no deep permeable soils.

- Irrigation required to maintain turf.

Maintenance

- May need occasional reseeding.
- Similar to maintenance of regular lawn, requiring mowing, fertilization, and irrigation.

Economics

- \$4-6 per square foot, installed.

Examples/resources

- Emergency access/fire lane. Guadalupe River Project, San José, CA.
- Parking lot with asphalt aisles, turf block stalls, University of Miami Orange Bowl Stadium, Miami, FL.
- Shopping mall expansion overflow parking, NEMO Project, CT.

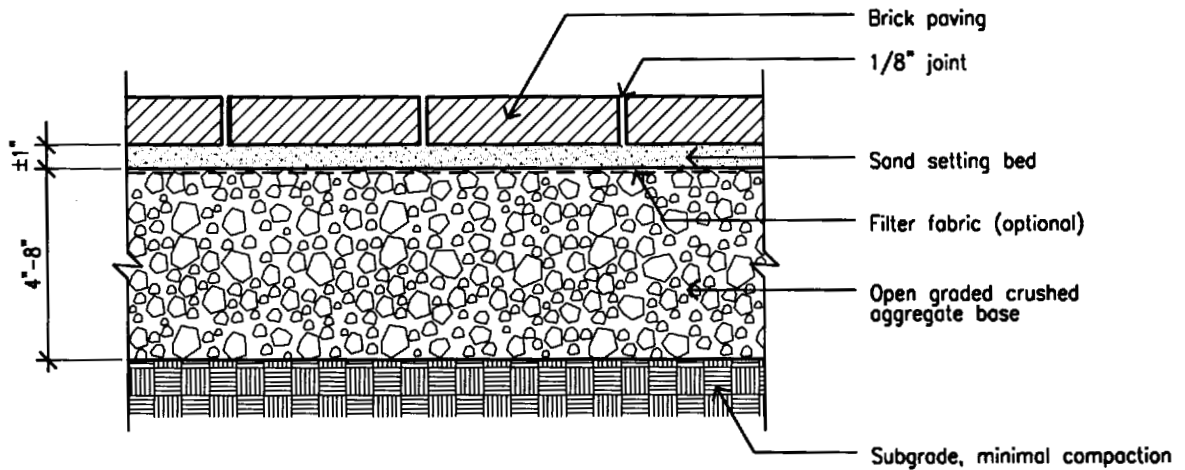

Conditions, dimensions, and materials shown are typical. Modifications may be required for proper application, consult qualified professional.

Brick is a solid unit paver available in a variety of colors and sizes, and a traditional building material with a long history. Bricks are typically laid either with sand joints on a crushed rock base, or with mortared joints on a concrete base. Only sand joints on a crushed rock base form a permeable pavement.

Characteristics

- Available in a variety of materials and finishes. Typically, bricks are rectangular in shape and made of a fired clay. Concrete bricks are also commonly available.
- Runoff coefficient: 0.13 to 0.76, depending on rainfall intensity and joint spacing. Brick pavement is more permeable in light rains and with wider joints.

Applications

- Driveways, walkways, patios, public sidewalks, plazas, low volume streets.
- Flat sites (slope $\leq 5\%$).
- Reduces impervious land coverage.

Design

- Because the bricks are laid loose, the field must be enclosed by a rigid frame. Concrete, mortared brick on a concrete grade beam, redwood header, and metal edging are commonly used.
- To maximize permeability, use an open-graded crushed rock base course (not rounded pea gravels, no fines).
- In areas with pedestrian traffic, make joints not larger than 1/4".
- Subgrade must be designed for anticipated loads.

Maintenance

- Longevity ensured by locating in low-erosion conditions, quality construction, and installation of good base layer.
- Easy to repair, since units are easily lifted and reset.
- Periodically add joint material (sand) to replace material that has been moved/worn by traffic or weather.
- Occasional weed suppression may be required.

Economics

- \$6–10 per square foot. Generally more expensive than concrete or asphalt, less expensive than brick on concrete.

Examples/resources

- Widely used as patios, plazas, sidewalks, driveways.

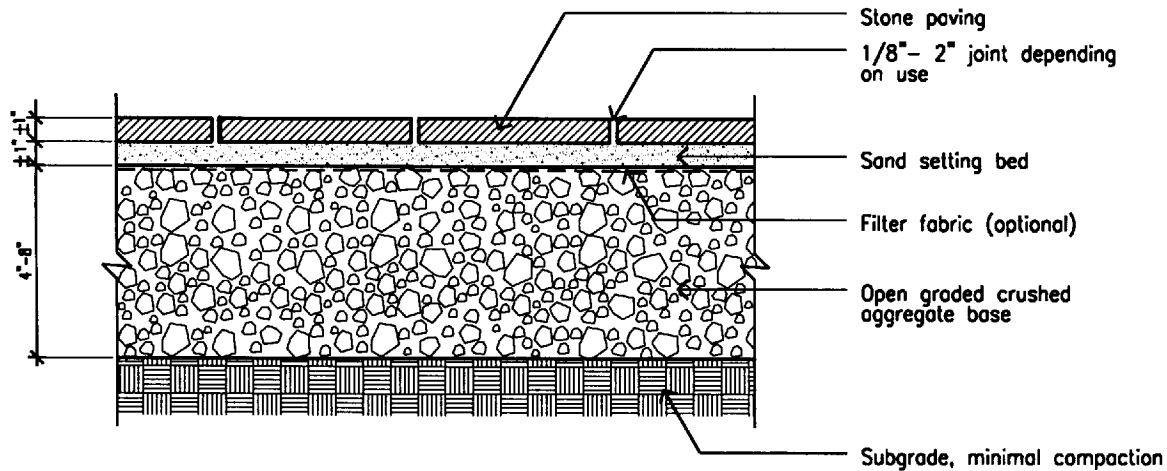

Conditions, dimensions, and materials shown are typical. Modifications may be required for proper application, consult qualified professional.

Natural stone paving is made of discrete units set in a pattern on a prepared base. A traditional building material with a long history, natural stone is typically laid either with sand joints on a crushed rock base, or with mortared joints on a concrete base. Only sand joints on a crushed rock base form a permeable pavement.

Characteristics

- Available in a variety of natural materials of varying colors, textures, shapes, and finishes. These include flagstone, slate, granite, and bluestone. For sand-set permeable pavement, the stone must be at least 1" thick— thinner pieces suitable for mortar-setting will crack if sand-set.
- Shapes range from random broken pieces of irregular patterns to cut stone of geometric patterns.
- Permeability is determined by the size of the joints. Large joints in patio or light traffic areas can be filled with plant material such as moss or turf.

- Runoff coefficient: 0.25 - 0.8 depending on joint size. Natural stone pavement is more permeable in light rains and with wider joints.
- Reduces impervious land coverage.

Applications

- Driveways, walkways, patios, low-use parking stalls.
- Flat sites (slope ≤ 5%).

Design

- Because the stone is laid loose, the field must be enclosed by a rigid frame. Concrete, mortared stone on a concrete grade beam, redwood header, and metal edging are commonly used.
- To maximize permeability, use an open-graded crushed rock base course (not rounded pea gravels, no fines).
- Subgrade must be designed for anticipated loads.

Maintenance

- Longevity ensured by locating in low-erosion conditions, quality construction, and installation of good base layer.
- Easy to repair, since units are easily lifted and reset.
- Periodically add joint material (sand) to replace material that has been moved/worn by traffic or weather.
- Occasional weed suppression may be required.

Economics

- Unit cost varies from \$10–25 per square foot, depending on material selected.

Examples/resources

- Parking lot stalls, La Casitas del Arroyo community building, Pasadena, CA.
- Widely used as patios, plazas, sidewalks, driveways.

Unit pavers on sand

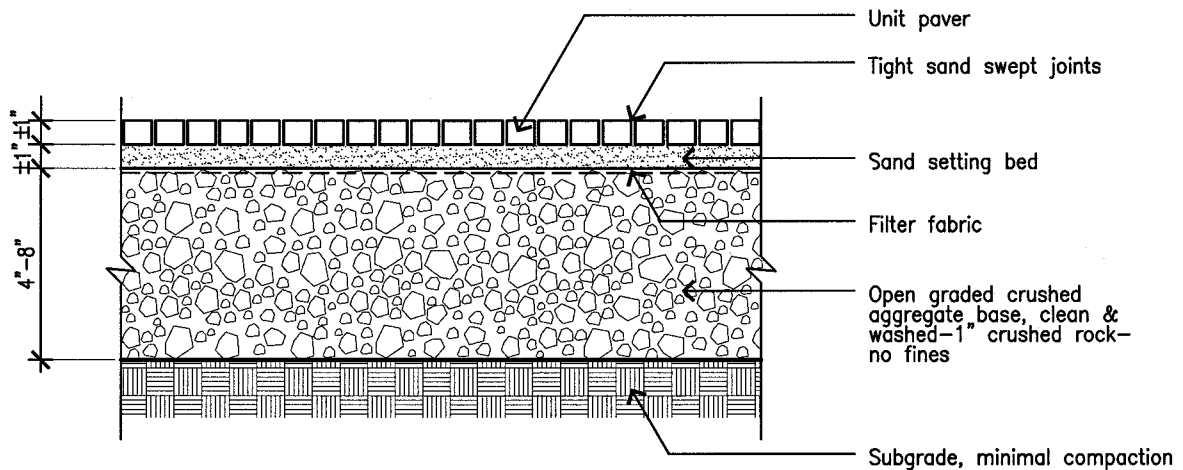

Conditions, dimensions, and materials shown are typical. Modifications may be required for proper application, consult qualified professional.

Unit pavers on sand are discrete units that are set in a pattern on a prepared base. A variation on traditional brick technology, unit pavers are typically made of pre-cast concrete in shapes that form interlocking patterns. Some of these shapes form patterns that include an open cell to increase permeability.

Characteristics

- Widely used as patios, plazas, side-walks, driveways.
- Open celled unit pavers are designed with precast voids to allow water to pass through.
- Solid unit pavers can form a permeable surface when spaced to expose permeable joints and set on a permeable base.
- Available in a variety of materials, colors and shapes.
- Runoff coefficient: 0.1 - 0.35 (more permeable with open cells or larger joints).
- Reduces impervious land coverage.

Applications

- Parking stalls, private driveways, walkways, patios.
- Can be used for low volume streets, travel lanes, bikeways.
- Flat sites (slopes $\leq 5\%$).

Design

- Because the unit pavers are laid loose, the field must be enclosed by a rigid frame. Concrete bands, metal or plastic edgings are commonly used.
- To maximize permeability, use an open-graded crushed rock base course (not rounded pea gravels, no fines).
- May not be suitable on expansive soils without special subgrade preparation.

Maintenance

- Longevity ensured by locating in low-erosion conditions, quality construction, and installation of good base layer.

- Easy to repair, since units are easily lifted and reset.
- Periodically add joint material (sand) to replace material that has been moved/worn by traffic or weather.
- Occasional weed suppression may be required.

Economics

- Installation cost \$9-15 per square foot
- More expensive than conventional concrete or asphalt, less expensive than unit pavers on slab.

Examples/resources

- Ecostone, SF RIMA are two manufacturers of open-celled concrete unit pavers.
- St. Andrews Church, Sonoma CA. uses Ecostone in drop-off area near entrance.
- 3170 Porter Drive, Palo Alto, uses Ecostone in parking lot stalls to increase permeability near heritage oak trees.

Crushed aggregate

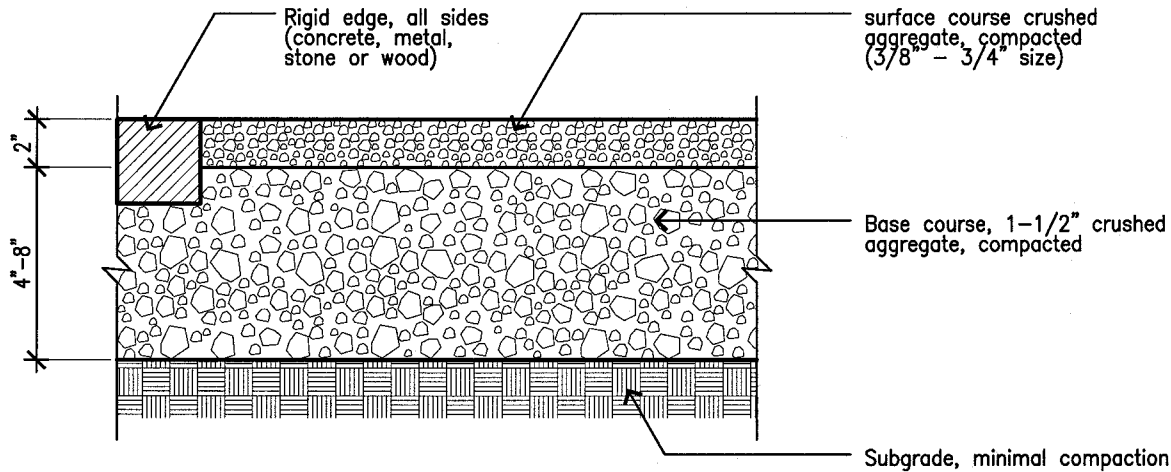

Conditions, dimensions, and materials shown are typical. Modifications may be required for proper application, consult qualified professional.

Crushed aggregate is crushed stone ranging from sand-sized “fines” to 2” diameter stone.

Characteristics

- A granular material, crushed aggregate can be laid in any shape field or configuration.
- Runoff coefficient 0.10 – 0.40. Pavements of fine crushed stone (e.g. decomposed granite fines) is relatively impermeable. Permeability increases with larger aggregate sizes. Open graded mixes are more permeable than mixes that include fines.
- Easy to install.
- Reduces impervious land coverage.

Applications

- Low volume, low speed vehicle traffic areas.
- Parking stalls, private driveways, walkways, patios.

- Areas of low erosion.
- Not appropriate for ADA-compliant accessible paths of travel.

Design

- Because the aggregate is laid loose, the field must be enclosed by a rigid frame in most applications. Concrete, mortared brick on a concrete grade beam, redwood header, and metal edging are commonly used.
- To maximize permeability, use an open-graded crushed rock base course (not rounded pea gravels, no fines).
- In areas with pedestrian traffic, use smaller aggregate (3/8” size). Larger aggregate (3/4” size) makes a better driving surface.

Maintenance

- Longevity ensured by locating in low-erosion conditions, quality construction, and installation of good base layer.

- Easy to repair, since aggregate is easily regraded and replenished.
- Occasional weed suppression may be required.
- To maximize permeability, minimize compaction of subgrade.
- Periodic and/or replenishing, raking of displaced gravel may be required.

Economics

- Less expensive than conventional asphalt or concrete pavement.
- Least expensive of all pavements, ranging from \$1 to \$3 per square foot.
- Reduced impervious land coverage reduces or eliminates need for catch basins/underground storm drain system.

Examples/resources

- Widely used as patios, plazas, driveways.

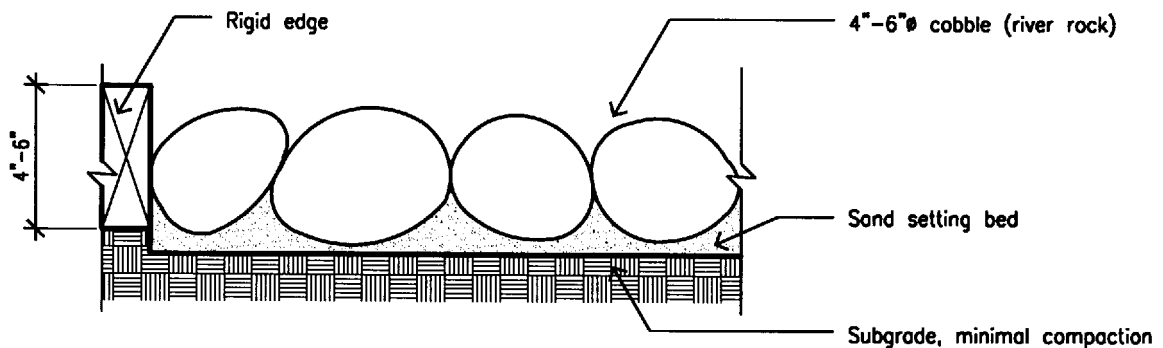

Conditions, dimensions, and materials shown are typical. Modifications may be required for proper application, consult qualified professional.

Cobbles are natural stones of various sizes. River rock is rounded, other cobbles can be angular in shape. Cobbles are typically set in native soil with soil joints or on a mortar bed with mortared joints. Only soil set cobbles are a permeable pavement.

Characteristics

- Can be laid in a fields of any shape or configuration, with or without base.
- Material varies in color, shape, and size.
- Runoff coefficient 0.60 – 0.90; higher for larger sizes.
- Easy to install.
- Reduces impervious land coverage.

Applications

- Garden areas.
- Not suitable for walkway surface.

Design

- Rigid edge such as concrete, brick, wood or metal band is useful to keep cobbles in place.
- To maximize permeability, use an open-graded crushed rock base course (not rounded pea gravels, no fines).
- Diameters range from 4” to 8”.
- A permeable filter fabric may be provided under the cobbles to suppress weeds and minimize migration of soil.

Maintenance

- Periodic weed suppression may be required.
- Resetting or replacement of cobbles may be required periodically.

Economics

- Easy to remove/reinstall
- Cost varies widely depending on material. Washed river rock is less costly than angular granite cobbles.

Examples/resources

- Commonly used around bases of trees in lawn areas.
- Commonly used in parkway planter strips and median islands.
- Commonly used as decorative mulch in landscaped areas.

8.2 Streets

More than any other single element, street design has a powerful impact on stormwater quality. Streets and other transport-related structures typically can comprise between 60 and 70% of the total impervious area, and, unlike rooftops, streets are almost always directly connected to an underground stormwater system.

From a technical point of view, streets present many complex design challenges. First, their design must respond to a variety of traffic loads, ranging from the most heavily travelled highway to the least travelled access street or lane. Second, street design is often mandated by a wide array of industry and government standards, many of which may conflict with current stormwater management practice.

The intent of the technical details that follow is two-fold:

- *to reduce the impervious surface area by “right-sizing” streets to fit the transportation demand, and*
- *to disconnect the street as far as possible from the underground stormwater system by incorporating infiltration/detention areas and swales into their design.*

Streets

Access street: urban neo-traditional standard

Access street: rural standard

Urban curb/swale system

Rural swale system

Dual drainage system

Concave median

Cul-de-sac

Access street: urban neo-traditional standard

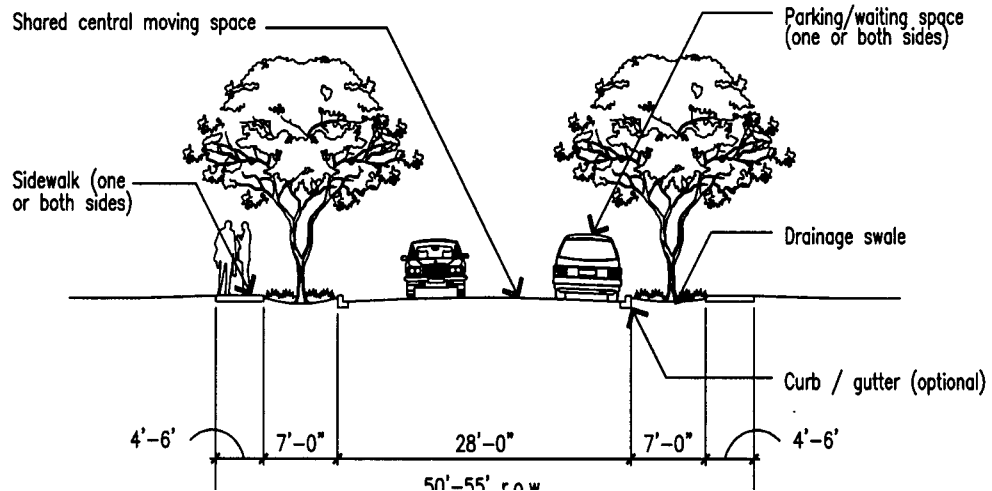

Conditions, dimensions, and materials shown are typical. Modifications may be required for proper application, consult qualified professional.

Urban neo-traditional standard access streets have a typical pavement width of 20 to 30' for vehicular movement and parking, as compared to conventional local streets, that typically require 36 to 40' of pavement.

Characteristics

- Central shared space for traffic in both directions.
- Sidewalks provided on one or both sides of the street depending on adjacent land uses, pedestrian needs.
- Parkway on one or both sides can be used for planting and surface drainage.
- Generally utilize curbs and gutters, though the gutter may be tied to a bio-filter or swale rather than an underground storm drain.
- Reduces impervious land coverage by up to 50 percent.

- Reduces sediment, oil and grease, hydrocarbons when combined with biofilters and swales.

Applications

- Appropriate for areas where traffic volumes are at or below 500-750 ADT and speeds between 15 to 25 mph.
- Most appropriate for grid street systems.
- May not be appropriate for long cul-de-sac streets or hillside sites with high fire risks (because of the potential of shared moving space to be blocked by a single vehicle, with no alternate emergency route).

Design

- Construction detailing same as typical street standard.
- Coordinate with local and regional zoning ordinances and public works standards.

- Streets with special uses, such as bike routes, may require additional pavement width.
- Depending on topography, parkway strip can be designed as a linear swale/biofilter, with curb openings directly into swale (see 6.2c Urban curb/swale system).

Maintenance

- Standard street maintenance practices required.
- Parkway strip between curb and sidewalk requires mowing, tree care. This can be the responsibility of the local jurisdiction or the adjacent property owner, depending on local codes and ordinances.

Access street: urban neo-traditional standard, continued

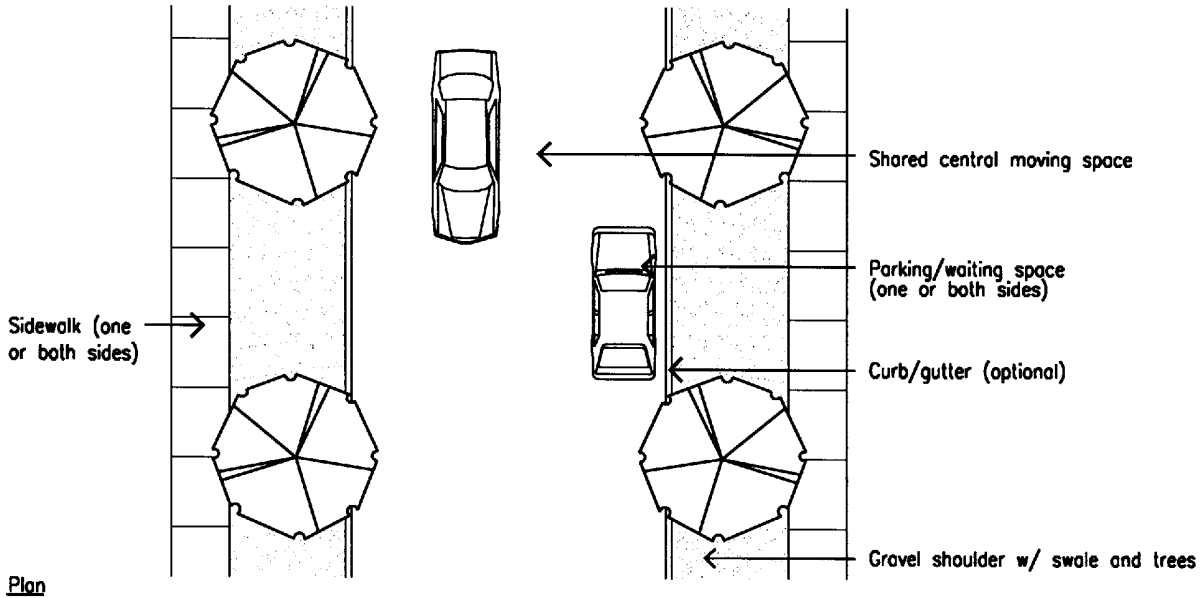

Conditions, dimensions, and materials shown are typical. Modifications may be required for proper application, consult qualified professional.

Economics

- Narrower street section reduces initial construction costs.
- Increased parkway adds additional landscape maintenance cost, especially compared with conventional street section without a parkway strip.
- Properties on narrower streets with tree-lined landscaped parkways typically command higher values than those on wider treeless streets.

Examples/resources

- Institute of Transportation Engineers (ITE) “Traditional Neighborhood Development Street Design Guidelines,” 1997.
- Skinny Streets program, Portland, OR.
- Velarde, Loreto Streets, Mountain View, CA.
- Typical of neighborhoods built before WWII.

Access street: rural standard

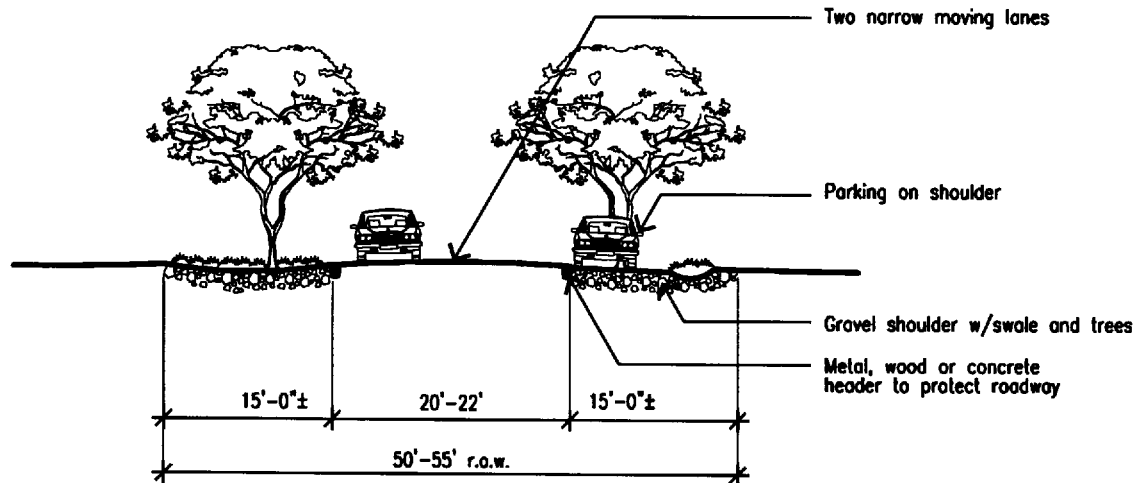

Conditions, dimensions, and materials shown are typical. Modifications may be required for proper application, consult qualified professional.

Rural standard access streets have an 18'–22' two-lane paved roadway, with no curb or gutters. Gravel or crushed aggregate shoulders act as drainageway and parking area.

Characteristics

- Vehicles tend use the center of the narrow paved roadway. When two cars are present moving in opposite directions, drivers reduce speeds and move towards the right hand shoulder.
- Permeability: Road is crowned to the gravel shoulders on each side. Reduced pavement width allows for shoulder on one or both sides that can be used for planting and surface drainage.
- Reduces impervious land coverage.
- Reduces sediment, oil and grease, hydrocarbons when combined with biofilters and swales.

Applications

- Appropriate for areas where traffic volumes are at or below 500-750 ADT and speeds between 15 to 25 mph.
- May not be appropriate for long cul-de-sac streets or hillside sites with high fire risks (because of the potential of shared moving space to be blocked by a single vehicle, with no alternate emergency route).
- Rural standard presents a more informal aesthetic and is suitable for less urban locations.

Design

- Roadway edge protection can be achieved by flush concrete bands, steel edge, or wood headers.
- Depending on topography, gravel shoulder can be designed as a linear swale/biofilter, with water sheet flowing directly into swale.

- Parking can be organized by bollards, trees, or allowed to be informal.
- Parking can be allowed only on one side to preserve a wider moving space for emergency vehicles.
- On very low volume, low speed, access streets, sidewalks may not be required, as pedestrians walk in the street or on the shoulder.
- If catch basins are used, provide settlement basin before inlet, or raise inlet above bottom of swale, to prevent sediment from filling catch basin.

Maintenance

- Gravel shoulders require periodic re-grading and replenishing.
- Elimination of curb means that conventional street sweeper machinery cannot be used.

Access street: rural standard, continued

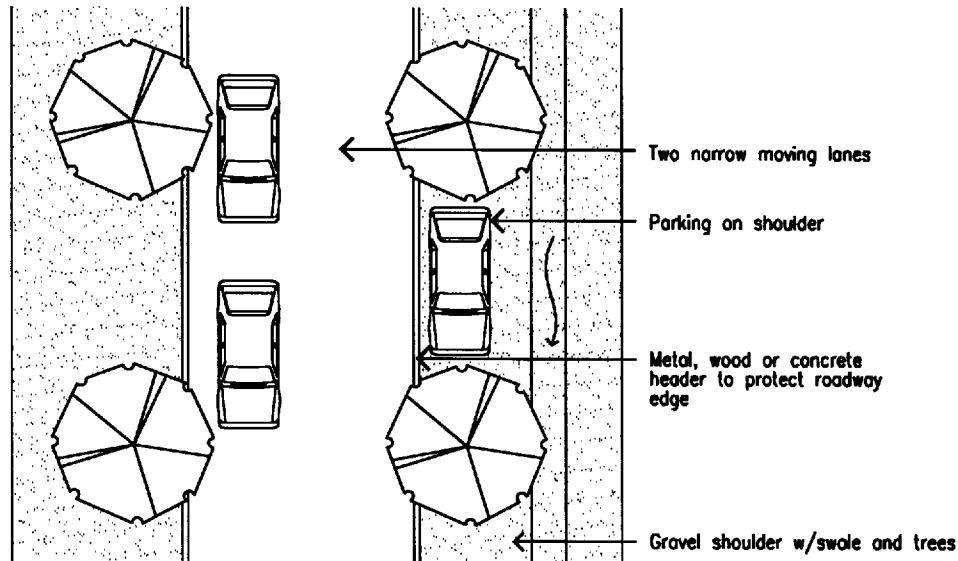

Conditions, dimensions, and materials shown are typical. Modifications may be required for proper application, consult qualified professional.

- Landscaped shoulder with surface stormdrain elements requires maintenance. This can be the responsibility of the local jurisdiction or the adjacent property owner, depending on local codes and ordinances.

Economics

- Narrower street section and elimination of curb and gutter reduces initial street construction costs significantly.
- Reduced roadway pavement width and increased infiltration in gravel shoulders reduces or eliminates need for underground stormdrain system.
- Landscaped shoulder with surface stormdrain elements adds moderate landscape maintenance cost.
- Properties on narrower streets with tree-lined landscaped parkways typically command higher values than those on wider treeless streets.

Examples/resources

- Institute of Transportation Engineers (ITE) “Traditional Neighborhood Development Street Design Guidelines,” 1997.
- Skinny Streets program, Portland, OR.
- Residential streets, Atherton, CA.
- Neighborhoods built before WWII.

Urban curb/swale system

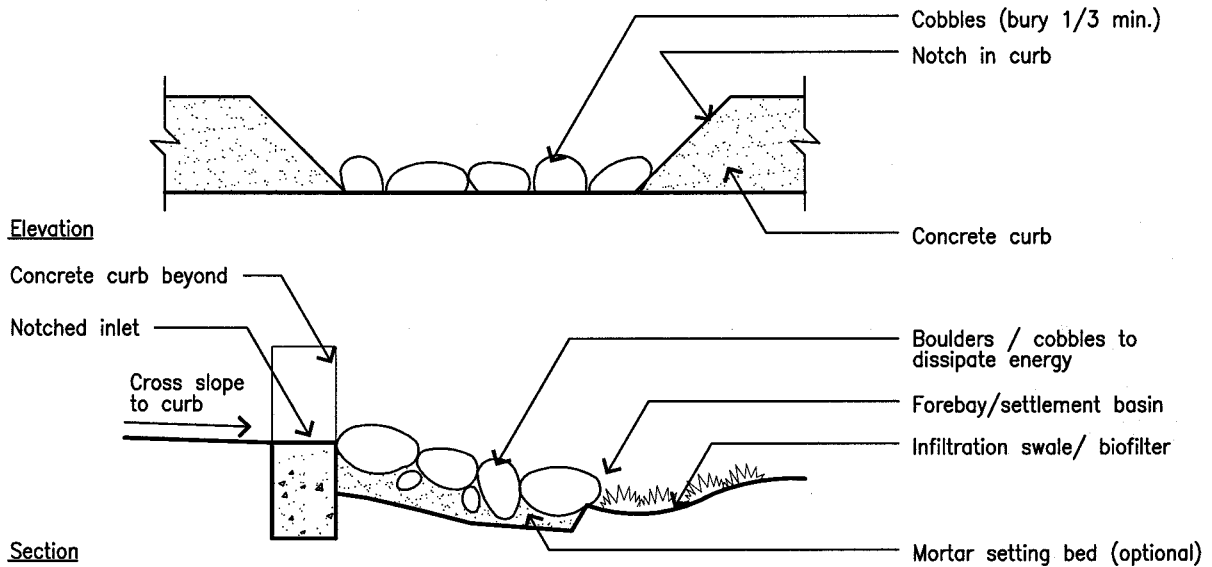

Conditions, dimensions, and materials shown are typical. Modifications may be required for proper application, consult qualified professional.

Urban curb/swale systems are a hybrid of standard urban curb and gutter with a more rural or suburban swale drainage system. It provides a rigid pavement edge for vehicle control, street sweeping, and pavement protection, while still allowing surface flow in landscaped areas for stormwater quality protection.

Characteristics

- Runoff travels along the gutter, but instead of being emptied directly into catch basins and underground pipes, it flows into surface swales.
- Stormwater can be directed into swales either through conventional catch basins with outfall to the swale or notches in the curb with flowline leading to the swale.
- Swales remove dissolved pollutants, suspended solids (including heavy metals, nutrients), oil and grease by infiltration.

Applications

- Residential developments, commercial office parks, arterial streets, concave median islands.
- Swale system can run either parallel to roadway or perpendicular to it, depending on topography and adjacent land uses.

Design

- Size curb opening or catch basin for design storm.
- Multiple curb openings closely spaced are better than fewer openings widely spaced because it allows for greater dissipation of flow and pollutants.
- Provide energy dissipators at curb notches or catch basin outfall into swale.
- Provide settlement basin at bottom of energy dissipator to allow for sedimentation before water enters swale.

Maintenance

- Annual removal of built-up sediment in settlement basin may be required.
- Catch basins require periodic cleaning.
- Inspect system prior to rainy season and during or after large storms.

Economics

- Cost savings through elimination of underground storm drain network.
- Cobble-lined curb opening may add marginal cost compared to standard catch basin.
- Swale system requires periodic landscape maintenance.

Examples/resources

- Residential street network, Village Homes subdivision, Davis, CA.
- Dual-drainage system, Folsom, CA.

Rural swale system

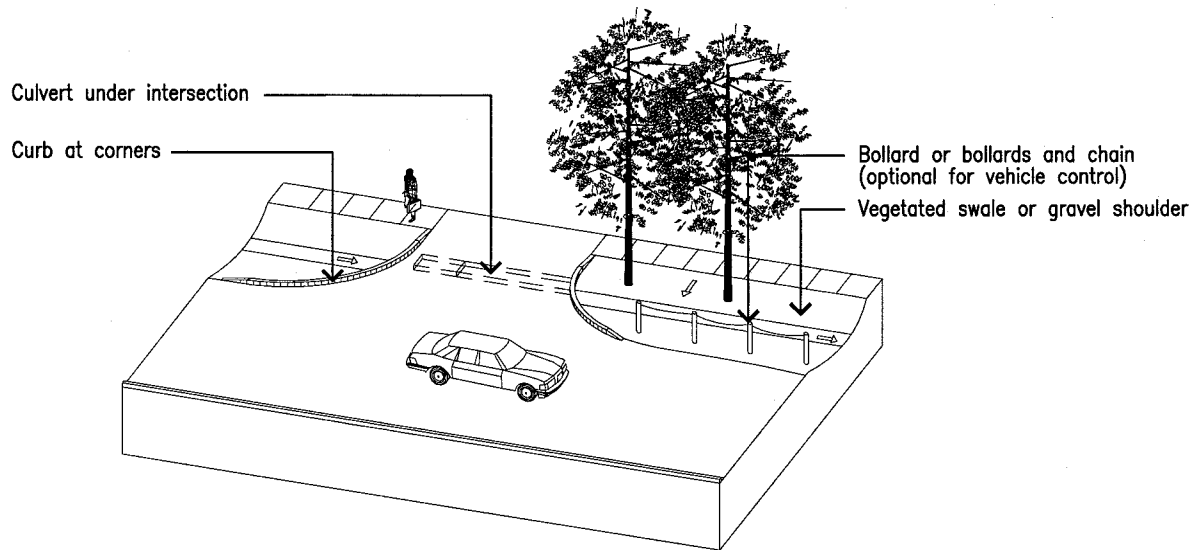

Conditions, dimensions, and materials shown are typical. Modifications may be required for proper application, consult qualified professional.

Rural swale systems are a combination of street design elements that allow for surface drainage while simultaneously protecting the roadway edge, organizing parking, and allowing for driveway access and pedestrian circulation.

Characteristics

- Shoulder can be designed to accommodate parking or to serve as a linear swale, permitting infiltration of stormwater along its entire length.
- Runoff from the street is not concentrated, but dispersed along its entire length, and build-up of pollutants in the soil is minimized.

Design

- Concrete curb and gutter not required.
- Ensure that culverts under intersections drain, to avoid standing water and resulting septic condition.

- Provide concrete curb at intersection radii to protect roadway edge and landscape area from turning movements.
- Crown street to direct runoff to shoulders. If drainage is provided on one side only, then provide cross-slope towards swale.
- Protect pavement edge with rigid header of steel, wood or a concrete band poured flush with the street surface.
- If parking is not desired on the shoulder, or if it needs to be organized, install bollards, trees or groundcovers along the shoulder to prevent vehicle trespass.
- Central medians can be used to divide traffic for safety or aesthetics.

Maintenance

- Surface systems require periodic maintenance and inspection.
- Maintenance for surface systems is different than most urban Public Works Departments currently practice, and employee retraining may be required.
- Surface drainage systems are easier to monitor and clear than underground systems, because problems, when they occur, are visible and on the surface. This eliminates the need for subsurface inspection or street excavation.

Economics

- Surface swales are less costly to install than underground pipe systems, but may have higher on-going maintenance costs.

Examples/resources

- City of Folsom, CA.

Dual drainage system

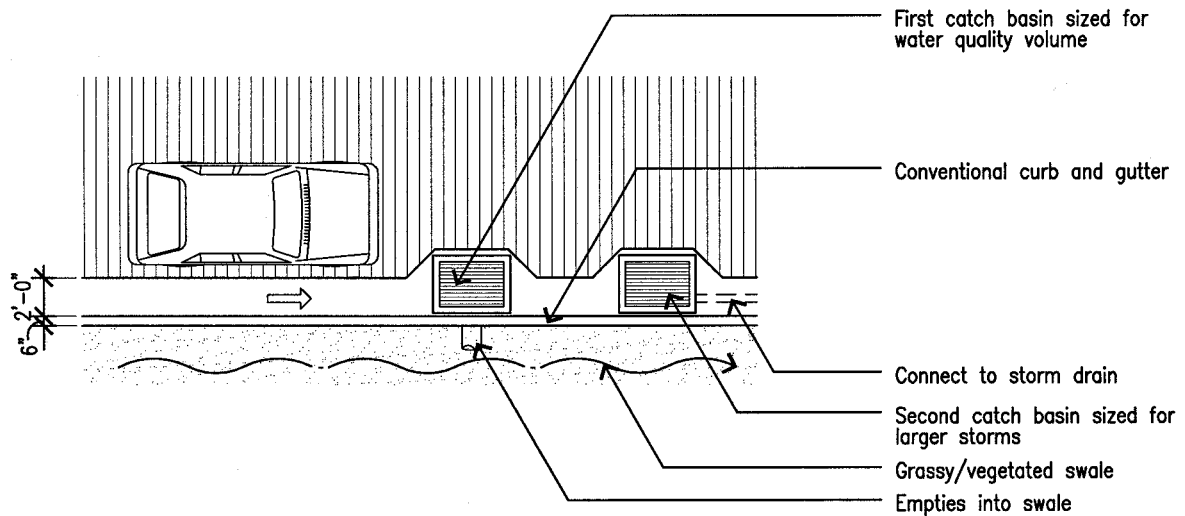

Conditions, dimensions, and materials shown are typical. Modifications may be required for proper application, consult qualified professional.

Dual drainage systems provide a pair of catch basins at each inlet point— the first is sized to direct the water quality volume into a landscaped infiltration area, and the second collects the overflow of larger storms and directs it to the storm drain system.

Characteristics

- “Treatment train” approach provides for both water quality and flood protection.
- Separation of water quality volume from larger storms provides a bypass that prevents flushing of sediment and pollutants in vegetated swale during larger storms.
- Appearance of typical urban street.

Applications

- Streets in residential or commercial developments, arterial streets.
- Swale can be located on shoulder or in concave median.

- Not appropriate for industrial areas due to the potential of spills.

Design

- Locate two catch basins adjacent to each other.

First (uphill) catch basin Design outlet pipe to accommodate the water quality volume and direct to adjacent grass or vegetated swale. When first catch basin is full (because inflow exceeds volume of outlet pipe), water will flow past first basin inlet and enter second catch basin.

Second (downhill) catch basin Design to accommodate larger volumes and connect outlet to underground storm drain system or to detention pond.

- Culverts must be provided to carry swale under cross streets and drive-ways.

- Design swale to accommodate water quality volume.
- If swale is planted with turf grass, provide supplemental irrigation to maintain turf.
- For additional information on swale design, see Technical Detail 6.6a Grass/vegetated swales.

Maintenance

- Perform standard maintenance practices on swale and catch basins.

Economics

- Dual drainage system is more expensive to install and maintain than other solutions because of multiple elements.

Examples/resources

- City of Folsom, CA, Highway 50 at Folsom exit. Contact City Engineer.

Concave median

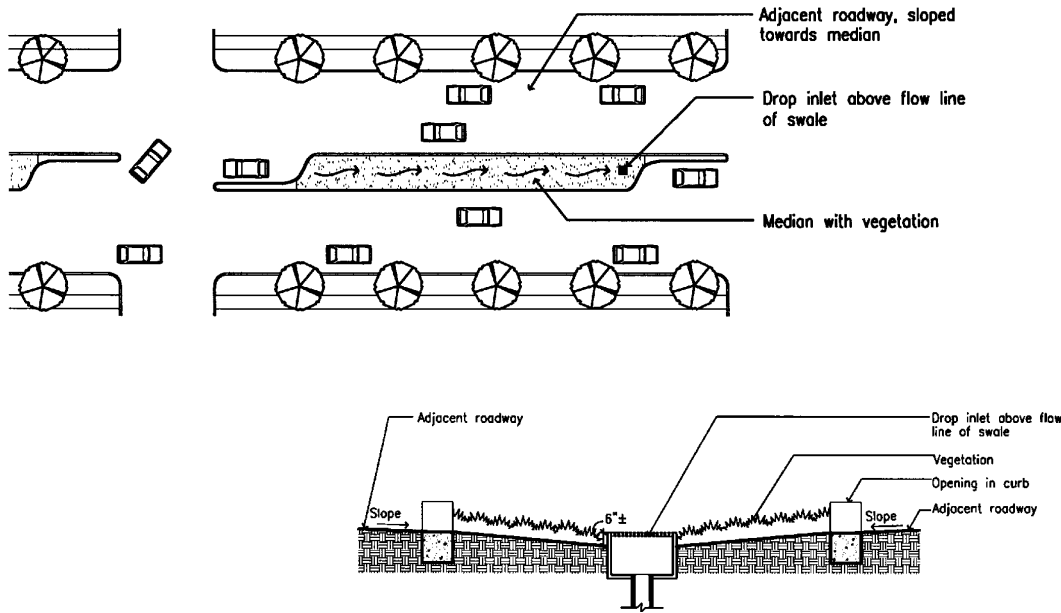

Conditions, dimensions, and materials shown are typical. Modifications may be required for proper application, consult qualified professional.

Concave medians. Conventional medians are normally designed as a convex surface to shed water onto adjacent pavement and into a curb and gutter system. Concave medians reverse this relationship by depressing the median surface slightly depressed below the adjacent pavement section and designing the median to receive runoff.

Characteristics

- Provides safety and aesthetic functions of traditional convex medians while accommodating stormwater infiltration.
- Helps to disconnect impervious street surface from storm drain system by directing street runoff into landscaped or aggregate-filled median for infiltration.
- Can be designed as a landscaped swale or turf-lined biofilter to treat first-flush runoff, which carries a high concentration of oils and other pollutants off the street.

Design

- Adjacent roadway design must provide cross-slope into medians.
- Runoff from street can be directed into swale by sheet flow or curb inlets.
- Concave medians must be sized to accommodate the water quality volume, and planting must be designed to withstand periodic inundation.
- Catch basin and underground storm drain system may be required for high flows, depending on the available area for infiltration and retention.
- Set catch basin rim elevations just below the pavement elevation, but above the flow line of the infiltration area so that the water quality volume will collect in the swale before overflowing into the underground system.

Maintenance

- Landscaped concave medians have maintenance requirements similar to landscaped convex medians.
- Some maintenance staff retraining may be required to facilitate maintenance of swales or other stormwater detention elements.

Economics

- Costs are similar to convex landscaped medians.

Cul-de-sac

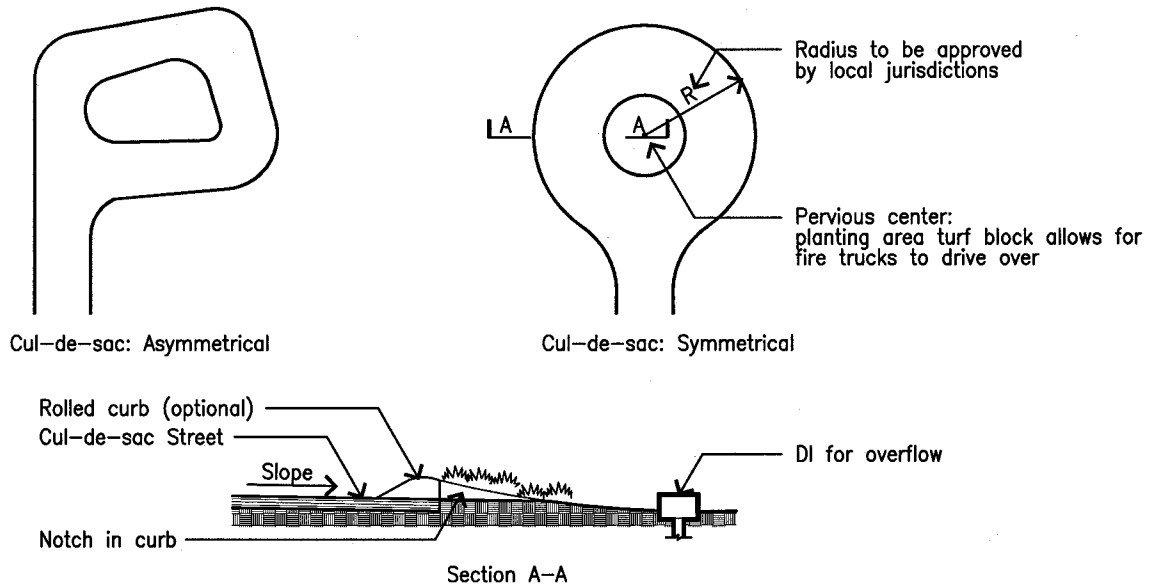

Conditions, dimensions, and materials shown are typical. Modifications may be required for proper application, consult qualified professional.

Cul-de-sac streets are dead-end streets that require turnaround areas large enough to accommodate large trucks and emergency access vehicles.

Characteristics

- Conventional cul-de-sacs are paved across their entire diameter. This large impervious area adds to environmental degradation by increasing runoff and creating a heat island at the front of adjacent land uses.
- A turnaround with a central concave landscaped space or other pervious surface can meet fire department access requirements and create an opportunity for stormwater infiltration or detention.
- A landscaped area in the center of a cul-de-sac can reduce impervious land coverage by 30 to 40%, depending on configuration, while maintaining the required turning radius.

Applications

- Appropriate for cul-de-sac streets in residential, commercial, and institutional settings.

Design

- Street termination requires turnaround area large enough to accommodate large trucks, such as occasional moving vans and emergency access vehicles (fire departments often require 60 feet or greater diameter turnarounds).
- Some local fire departments may require the center landscaped area to accommodate fire trucks. This can be achieved by providing a permeable load bearing surface such as turf-block, and eliminating woody plant materials such as trees from the planting area.
- Asymmetrical cul-de-sac design is more rural than conventional round cul-de-sac design.
- Curb with slots may be needed to allow run-on from the street while keeping vehicles off landscaping.

Maintenance

- Similar to other planted medians.

Economics

- Cost of extending storm drain the length of the cul-de-sac may outweigh the savings gained from reduction of paved area.
- Landscaping in center island may add costs for irrigation, planting, and periodic maintenance.

8.3 Parking Lots

In any development, storage space for stationary automobiles can consume many acres of land area, often greater than the area covered by streets or rooftops.

T*he standard parking stall occupies only 160 square feet, but when combined with aisles, driveways, curbs, overhang space, and median islands, a parking lot can require up to 400 square feet per vehicle, or nearly one acre per 100 cars. Since parking is usually accommodated on an asphalt or concrete surface with a conventional underground storm drain system, parking lots typically generate a great deal of directly-connected impervious area. Because the cars sitting in these lots shed hydrocarbons, heavy metals and other pollutants, parking lots are a primary collector and conveyor of urban runoff pollution.*

There are many ways to both reduce the impervious land coverage of parking areas and to filter runoff before it reaches the storm drain system.

Parking Lots

Hybrid parking lot

Parking grove

Overflow parking

Porous pavement recharge bed

Hybrid parking lot

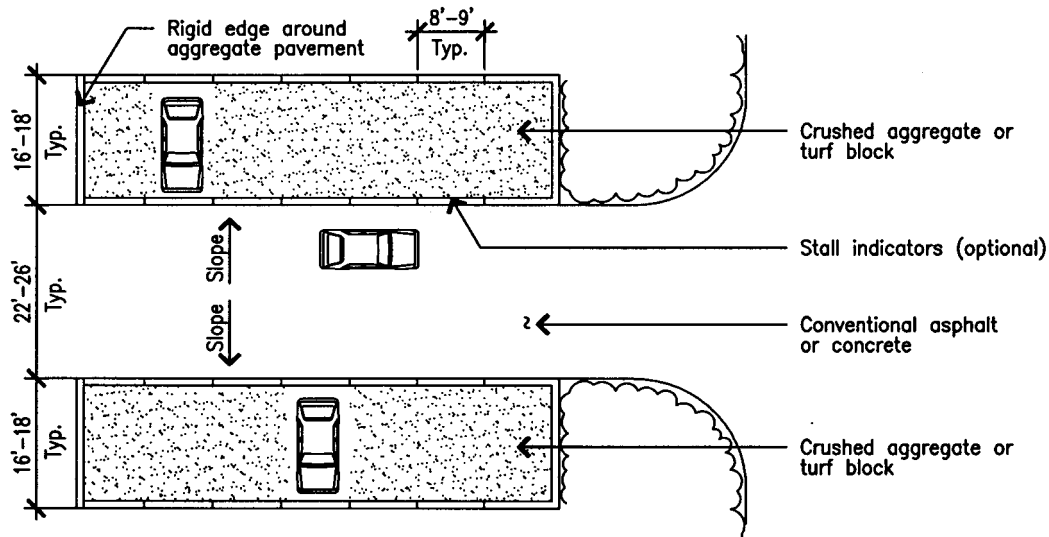

Conditions, dimensions, and materials shown are typical. Modifications may be required for proper application, consult qualified professional.

Hybrid parking lots differentiate paving, combining impervious aisles with permeable stalls. Impervious aisles are designed to carry moving vehicle traffic and accommodate turning movements. Permeable stalls are designed for stationary or very slow moving cars. There are many possible combinations of materials.

Characteristics

- Hybrid lot can reduce the overall impervious surface coverage of a typical double-loaded parking lot by 60%, and avoid the need for an underground drainage system.
- Differentiation between aisles and stalls can mitigate the overall visual impact of the parking lot.

Applications

- Commercial areas, offices, multi-family housing, hotels, restaurants.
- Selection of permeable pavement material depends on use. Porous asphalt, pervious concrete or unit pavers are

recommended for stalls in areas with high turnover, such as restaurants. Areas with low turnover, such as hotels, office buildings, and housing can use crushed aggregate for stalls.

- Variable permeability, depending on pavements chosen.
- High ground water or lack of deep, permeable soils may limit applications.

Design

- Keep permeable pavement areas relatively flat (slope $\leq 5\%$). See Section 6.1 Permeable pavements.
- Aisles are constructed of conventional asphalt or concrete suitable for heavier traffic use, speeds between 10 and 20 mph, and designed to support the concentrated traffic of all vehicles using the lot.
- Stalls are constructed of a permeable pavement, such as open-graded crushed aggregate, open-celled unit pavers, turfblock, porous asphalt, or

pervious concrete.

- Slope aisles into adjacent permeable stalls.
- Subdrain or overflow drainage may be required depending on design storm and underlying soils.
- Stall markings can be indicated with wood headers laid in field of permeable pavement, change in unit paver color, concrete bands or pavement markers (“botts dots”), depending on the material used.
- Designated handicapped stalls must be made of an ADA compliant pavement.

Maintenance

- Periodic weed control, sweeping, and regrading required for gravel stalls.
- Irrigation, fertilizer, weed control, and mowing required for turf block stalls.
- Pressure hosing or vacuum sweeping may be required for pervious concrete or porous asphalt stalls.

Hybrid parking lot, continued

Economics

- Reduction of overall impervious surface coverage may eliminate or reduce need for underground drainage system.
- Construction cost will depend on materials chosen. A hybrid lot of conventional asphalt aisles with crushed aggregate stalls will be lower cost than a lot entirely paved in asphalt. A hybrid lot of conventional asphalt aisles with unit pavers stalls will be higher cost than a lot entirely paved in asphalt.

Examples/resources

- Parking lot. Medford Village, NJ.

Parking lots

Parking grove

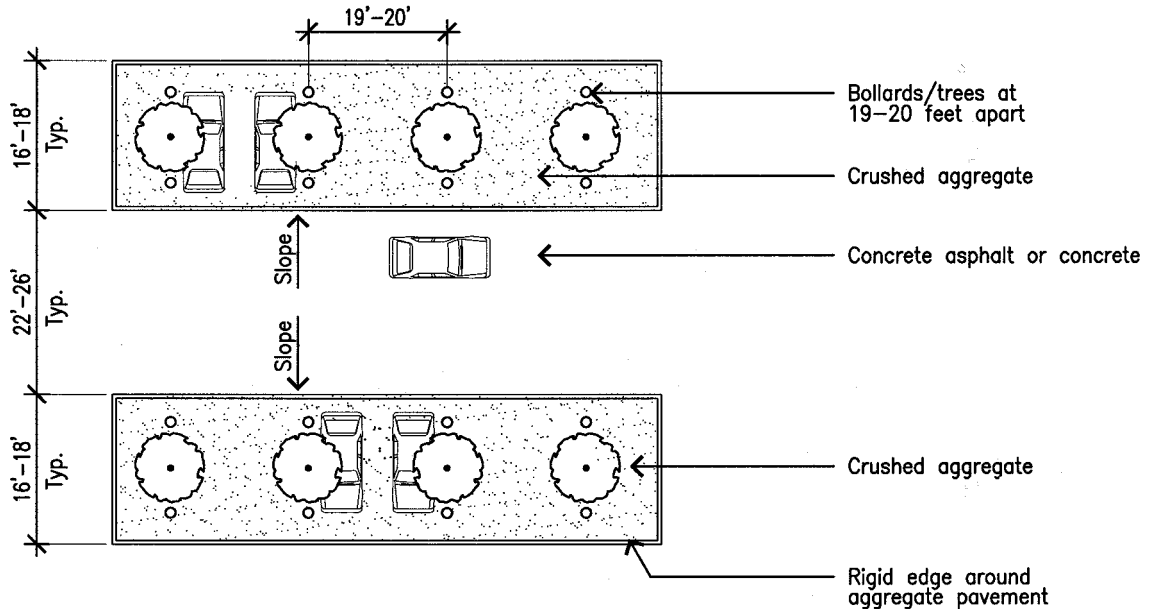

Conditions, dimensions, and materials shown are typical. Modifications may be required for proper application, consult qualified professional.

Parking groves, a variation on the hybrid parking lot design (See 6.3a), use a grid of trees and bollards to delineate parking stalls and create a shady environment. The permeable stalls reduce impervious land coverage while the trees reduce heat island effect and improve soil permeability.

Characteristics

- Parking grove not only shades parked cars, but presents an attractive open space when cars are absent.
- Permeability depends on the type of pavement used.
- Reduces impervious land coverage.

Applications

- Best in locations where the users of the parking lot are a consistent group of people (such as multi-family housing or an office building) who become familiar with parking between the trees.
- Best in situations where vehicles park for long periods of time, such as hotels, housing, offices.

- Not recommended for high turnover lots, such as restaurants and commercial areas because of additional care needed to navigate around trees.

Design

- Parking stalls must be oversized to accommodate thickness of bollards and trees. A grid of trees/bollards spaced approximately 19 feet apart allows two vehicles to park between each row of the grid (9.5 foot space per stall, compared to the standard 8.5 to 9 foot space per stall). A grid of 28 to 30 feet allows for three cars between each pair of trees.
- Set trees/bollards at least three feet in from end of stall to allow for turning movements into and out of stall.
- Trees should be protected during the establishment period with double staking of 3" diameter wood stakes. Align stakes along implied stall line.
- Bollards may be omitted if proper tree staking is provided during establishment period.

- Metal tree cages are not recommended because they are easily damaged and can scratch cars.
- Trees should be selected for high, horizontal branching structure, and should not be prone to limb breakage (such as Eucalyptus spp. and Grevillea robusta), or insects that secrete honeydew (such as Celtis).
- Provide irrigation to trees as required.

Maintenance

- Requires tree pruning and maintenance to ensure clearance of vehicles.
- Trees may occasionally be hit by cars, but will heal themselves under normal circumstances.

Economics

- More expensive to construct and maintain than standard parking lots.

Examples/resources

- Seaside Motel Auto Court, Seaside, FL.

Overflow parking

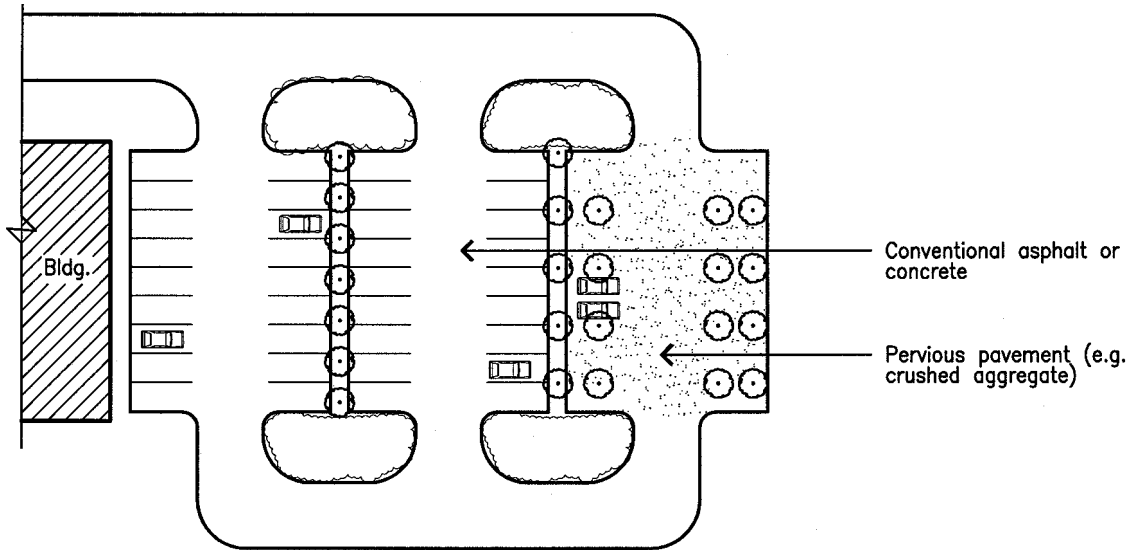

Conditions, dimensions, and materials shown are typical. Modifications may be required for proper application, consult qualified professional.

Overflow parking design differentiates between regular and peak parking demands, constructing the regular demand parking stalls with traditional impervious materials and constructing peak parking stalls of a different, more permeable, material.

Characteristics

- Overflow area can be pervious materials such as turf block, crushed stone, unit pavers on sand, and can be designed to break up an expanse of continuous parking lot.
- Permeability depends on pavement used.

Applications

- Large parking lots with variable capacity needs such as shopping malls, conference centers, office complexes, amusement parks, sport facilities.

- Visitor parking areas in multifamily residential developments or office complexes.
- Facilities with infrequent but extensive peak parking needs, such as churches, sports arenas, and conference centers.

Design

- Must be designed to accommodate volume of overflow parking.
- In many uses, regular parking demand accounts for approximately two-thirds of total, with one-third accommodated as overflow.
- Irrigation may be necessary if overflow parking is turf block.

Maintenance

- Maintenance depends on pavement selected.

Economics

- Cost depends on pavement selected and overall design.

Examples/resources

- Gravel overflow parking at Nordstrom parking lot. Corte Madera, CA.
- Orange Bowl parking lot, FL.

Porous pavement recharge bed

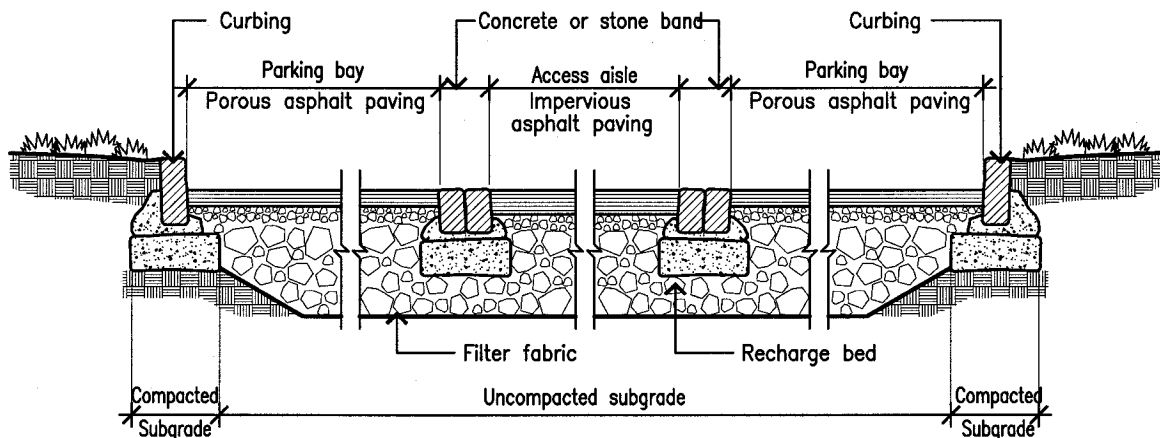

Conditions, dimensions, and materials shown are typical. Modifications may be required for proper application, consult qualified professional. Detail adapted from Andropogon Associates.

Porous pavement recharge beds underneath parking lots are gravel beds that receive and store infiltration.

Characteristics

- Underground system eliminates the possibilities of mud, mosquitoes and safety hazards sometimes associated with ephemeral surface drainage.
- Provides for storage of large volumes of runoff, which is directed underground by means of perforated distribution pipes.
- Constraints include soil infiltration rates, depth to water table and bedrock, and traffic type and volume.

Applications

- Underneath parking lots generally in areas where land values are high and the need to control runoff is great.

Design

- 2-1/2" porous asphalt paving on clean gravel topcourse.
- Recharge and storage basin of clean open-graded crushed stone with 40% void space.
- Filter fabric placed on floor and sides of recharge bed following excavation allows water to pass readily, but prevents soil fines from migrating up into rock basin, reducing effective storage area of recharge bed.
- Design an unpaved edge of porous pavement, and top off with stone (such as river stone), place wheelstops at edge. This functions as an emergency overflow inlet around perimeter of parking bay.
- Limit porous surfaces to parking areas receiving least wear and tear.
- Soil layer of 4 feet or more with percolation rate of 0.5 inches per hour or more required; must be field tested.

- Direct all sediment-laden runoff from impervious surfaces (e.g., roof tops, roads, parking areas, walkways, etc) away from porous pavement/recharge bed or pretreat to eliminate sedimentation.
- Prevent failures by implementing strict erosion/sediment control during construction (sediment that erodes or is tracked on to the surface can clog void spaces in pavement and prevent stormwater from entering the recharge bed below).

Maintenance

- Vacuum sweeping or pressure hosing recommended twice per year under normal circumstances.

Economics

- Expensive, requires extensive engineering.

Examples/resources

- Morris Arboretum, Philadelphia, PA.
- Automatic Data Processing corporate offices, Philadelphia, PA.

8.4 Driveways

Driveways can comprise up to 40% of the total transportation network in a conventional residential development, with streets, turn-arounds and sidewalks comprising the remaining 60%.

There are several ways to reduce the impact of driveways on water quality. These include directing runoff from an impervious driveway to a landscaped infiltration area, constructing the driveway from a permeable pavement, and reducing the overall amount of pavement provided.

Driveways

- Not directly-connected impervious driveway
- Gravel driveway
- Unit pavers on sand
- Paving only under wheels
- Flared driveways
- Temporary parking

Not-directly connected impervious driveway

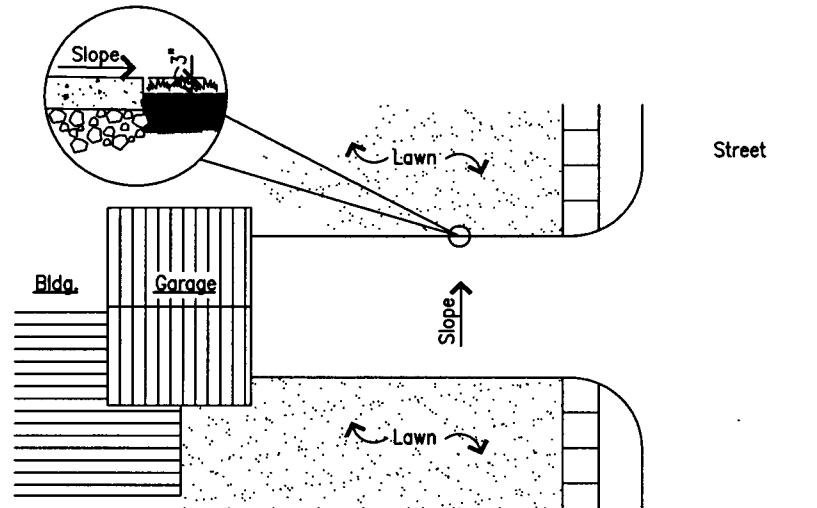

Conditions, dimensions, and materials shown are typical. Modifications may be required for proper application, consult qualified professional.

Not directly-connected impervious driveway slopes the surface to drain into an adjacent turf or groundcover area, rather sloping towards the curb and gutter in the street as commonly done.

Characteristics

- Appearance is the same as conventional driveway.
- Pollutants are dispersed and cleansed in the soil as driveway runoff passes through a permeable landscaped area.

Applications

- Suitable for all driveways with sufficient adjacent landscape areas.

Design

- Cross slope must be greater than longitudinal slope to direct runoff into adjacent landscape
- Adjacent landscaped area must be sized to accommodate the water quality volume.

- Edge of driveway must be approximately 3 inches above the vegetated area, so that vegetation or turf doesn't block sheet flow from driveway onto soil.

Maintenance

- Edging of adjacent lawn is important to allow unimpeded flow of runoff from driveway onto lawn.

Economics

- Cost is same as conventional driveway.

Crushed aggregate driveway

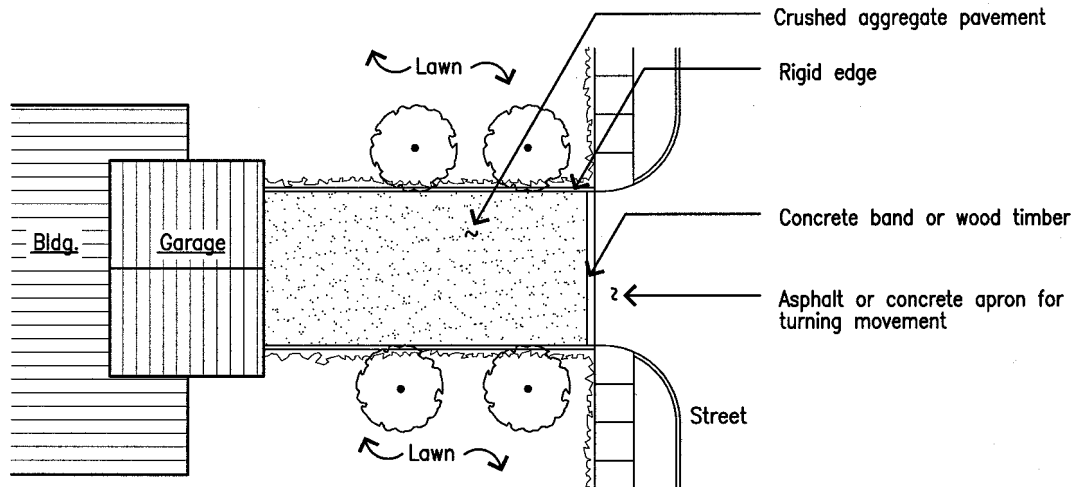

Conditions, dimensions, and materials shown are typical. Modifications may be required for proper application, consult qualified professional.

Crushed aggregate driveway.

Crushed stone and other granular materials can make a relatively smooth permeable pavement suitable for the low speeds and volumes of typical residential driveways.

Characteristics

- Aesthetic can be formal or rural depending on design and materials.
- Crushed aggregate driveways have a distinctive “crunchy” sound reminiscent of traditional country estates and homes.

Applications

- For driveways that are lightly used by very slow moving vehicles, and those that serve single family homes.
- Not suitable for multi-use driveways such as those that accommodate children’s play.
- Flat sites (slope $\leq 5\%$).

Design

- Rigid edge such as wood header, concrete, metal, or brick band desirable to contain aggregate material and to maintain surface strength.
- Provide a non-granular apron at intersection of driveway with street to accommodate turning movements.
- Provide a concrete band or wood timber at transition between apron and crushed aggregate driveway to absorb impact of repeated wheel crossings.
- Use open-graded crushed aggregate (such as 3/8” to 3/4” granite) rather than rounded stones such as pea gravel. Angles of the crushed stone form a matrix that holds the granular material in place, able to bear the load traffic without substantial displacement.
- Minimize compaction of finished grade and subgrade. Roll surface of aggregate sufficiently to stabilize the stone.

- Open-celled plastic matrix can be used to provide added stability of crushed aggregate.

Maintenance

- Weed control may be needed periodically.
- Periodic replenishment of aggregate may be required.

Economics

- Least cost of all pavement materials.
- \$1 to \$3 per square foot, depending on design.

Examples/resources

- Open-celled matrixes are available from Gravelpave, GeoWeb by Presto.

Unit pavers on sand driveway

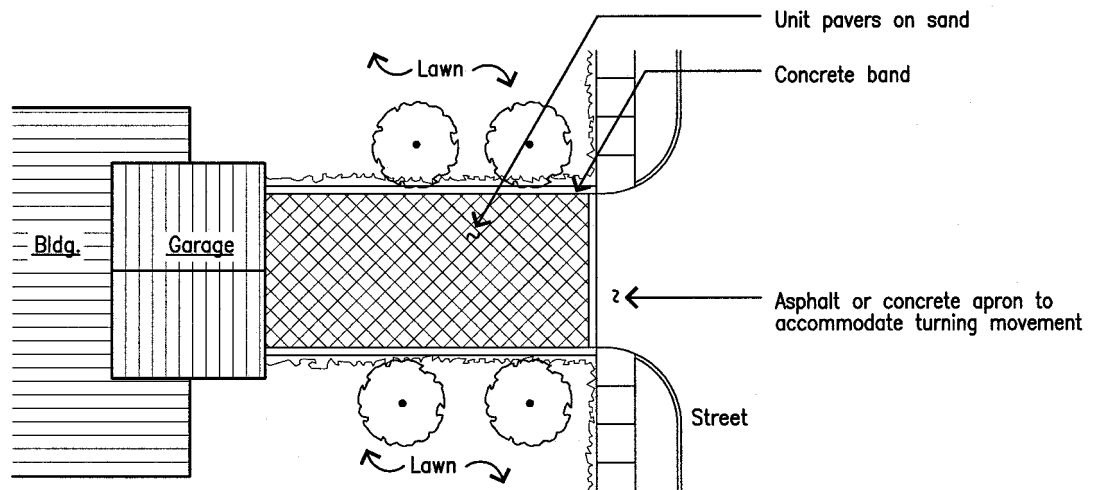

Conditions, dimensions, and materials shown are typical. Modifications may be required for proper application, consult qualified professional.

Unit pavers on sand are discrete units that are set in a pattern on a prepared base and bound by a rigid edge to form a pavement suitable for a driveway.

Characteristics

- A pavement of brick or unit pavers on sand can make the driveway more integrated with the garden rather than an extension of the street penetrating deep into the garden space.
- Available in a variety of natural and synthetic materials, such as brick, natural stone, cast concrete.
- Runoff coefficient of open celled units: 0.10-0.35 (more permeable if larger voids, solid units: 0.10-0.20. Infiltration rates are higher during lighter, lower intensity rains.

Applications

- Residential driveways.
- Accent to traditional asphalt in low volume commercial driveway.
- Flat sites (slope \leq 5%).

Design

- Because the unit pavers are laid loose, the field must be enclosed by a rigid frame. Concrete bands, metal or plastic edging are commonly used.
- To maximize permeability, use an open-graded crushed rock base course (not rounded pea gravels, no fines).
- May not be suitable on expansive soils without special subgrade preparation.

Maintenance

- Longevity ensured by locating in low-erosion conditions, quality construction, and installation of good base layer.
- Easy to repair, since units are easily lifted and reset.
- Periodically add joint material (sand) to replace material that has been moved/worn by traffic or weather.
- Occasional weed suppression may be required.

Economics

- Installation cost \$9-15 per square foot
- More expensive than conventional concrete or asphalt, less expensive than unit pavers on slab.
- Increased construction and maintenance costs can be offset by improved aesthetic and market appeal compared to conventional asphalt or concrete driveways.

Paving only under wheels

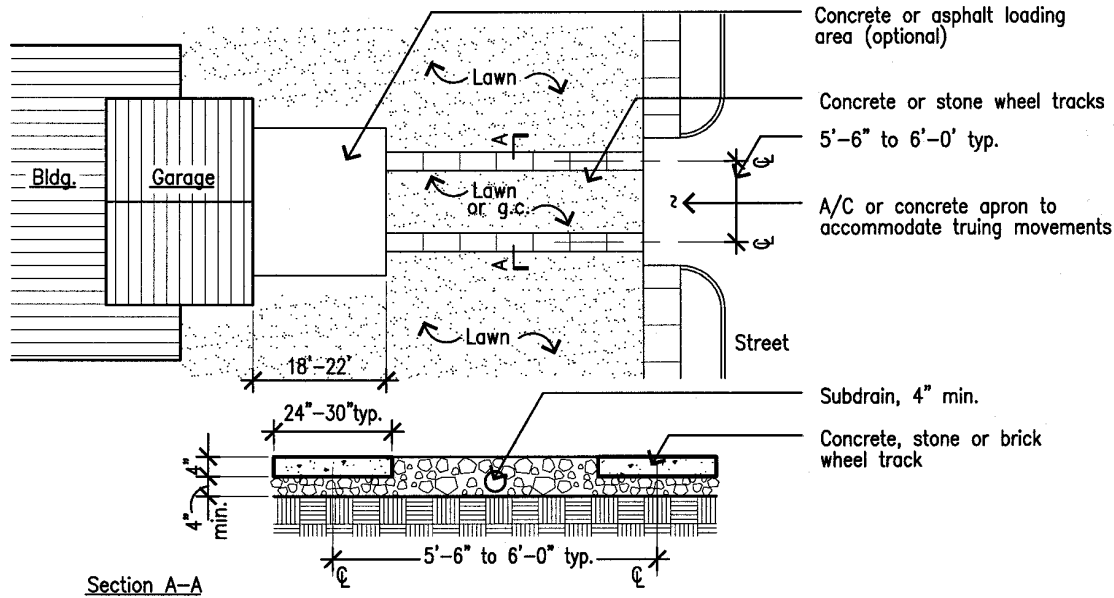

Conditions, dimensions, and materials shown are typical. Modifications may be required for proper application, consult qualified professional.

Paving only under wheels. Paving only under the wheel tracks, with the area between landscaped reduces impervious land coverage, also called a “Hollywood driveway.”

Characteristics

- Center strip planted with grass, groundcovers, or filled with gravel.
- A driveway of two paved wheel tracks can reduce impervious surface coverage by 60 to 70% compared with a single lane paved driveway.

Applications

- Residential, low density single family, duplex, mobile home.
- Best in straight driveways, not recommended for curving driveways.

Design

- Wheel tracks should be wide enough to accommodate variability in driving and vehicle widths.
- Wheel tracks must be designed to support vehicle loads, usually concrete or mortar-set unit pavers such as stone or brick.
- A perforated drain line buried between wheel tracks to collect and direct runoff may be added in soils with low infiltration rates.
- If ground cover or grass is selected for center strip, irrigation system must be provided, and parked vehicles must be moved periodically so that a single location is not continuously shaded.

Maintenance

- Area between wheel tracks requires maintenance.
- If area between tracks is planted with lawn, additional edging will be needed.

Economics

- Reduced pavement area reduces construction costs.
- Complex detailing, inclusion of landscape planting and irrigation can add significant costs.

Flared driveways

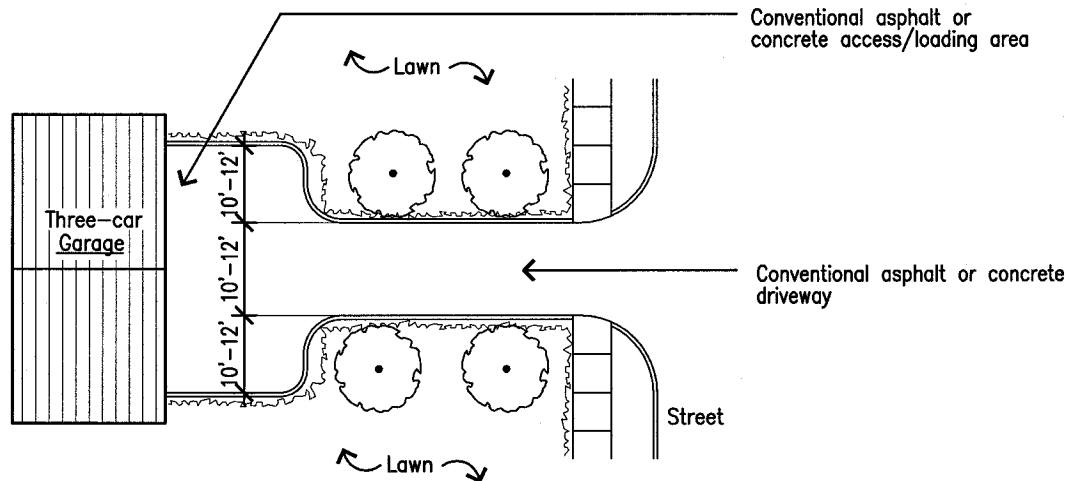

Conditions, dimensions, and materials shown are typical. Modifications may be required for proper application, consult qualified professional.

Flared driveways use a single lane to provide access to multiple-car garages by flaring the area in front of the garage.

Characteristics

- The approach to the garage from the street is a single lane, adequate to accommodate the relatively infrequent vehicle trips, while the portion of the driveway at the garage is widened to provide access to all garage doors.
- Reduces impervious surface area compared to multi-lane driveway extending entire length from garage to street.

Applications

- Appropriate for multi-car garages or single family homes with adjacent garages that do not require the full multi-lane width along their entire length.

Design

- Typical driveway design, single lane width at street, and flare to serve garages that are shared.
- Provide adequate depth in front of multi-car garage for vehicle parking and maneuvering.

Maintenance

- Same as standard driveway.

Economics

- Reduces overall pavement cost.

Temporary parking

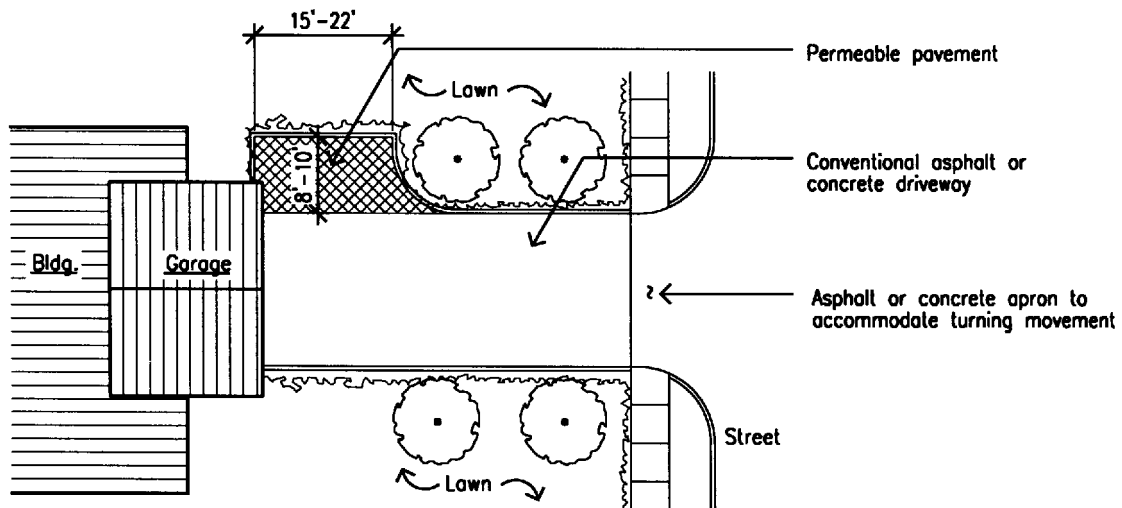

Conditions, dimensions, and materials shown are typical. Modifications may be required for proper application, consult qualified professional.

Temporary parking is paved with a permeable surface, such as turf-block or open-celled unit paver, and maintained as a landscaped surface.

Characteristics

- Appears and functions as green space or patio for the majority of the time when not used for parking.
- Runoff coefficient depends on the type of pavement used.
- Reduces impervious surface area.

Applications

- Residential driveway applications, such as RV or trailer parking.
- Areas where parking or loading access is required infrequently.
- Guest parking areas.

Design

- Must be designed to support vehicle loads.

Maintenance

- Turf-block requires similar maintenance as conventional lawn.
- Brick or unit pavers require periodic weed suppression.

Economics

- Higher initial cost than asphalt or concrete parking areas.
- Increased construction and maintenance costs can be offset by improved aesthetic and market appeal compared to conventional asphalt or parking areas.

8.5 Buildings

By definition, buildings create impervious land coverage. There are, however, techniques to treat runoff from individual buildings and to collect rooftop runoff for infiltration into the soil.

Roof runoff is typically either channeled in gutters and downspouts or allowed to sheetflow off the roof. Downspouts focus runoff, concentrating the entire watershed of the roof into one or a few points. This concentrated flow can be stored and slowly infiltrated into the soil in a controlled manner through dry-wells, cisterns, or by directing flow into landscape infiltration/detention areas.

Sheet runoff from roofs can be directed and infiltrated onto adjacent landscape areas through grading, mulching, and plant selection.

Buildings

Dry-well

Cistern

Foundation planting

Pop-up drainage emitters

Dry-well

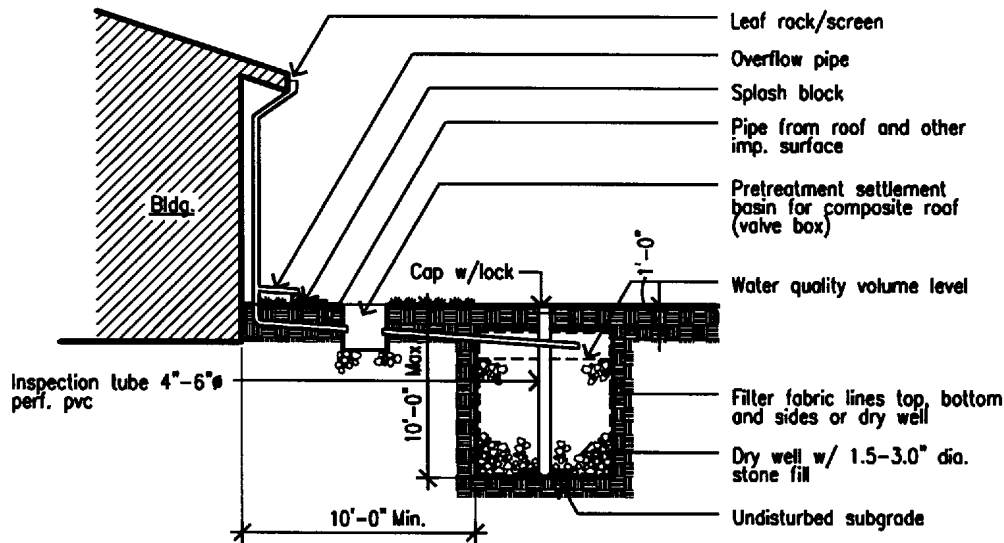

Conditions, dimensions, and materials shown are typical. Modifications may be required for proper application, consult qualified professional.

Dry-well. A dry-well is a subsurface basin to which runoff is diverted for infiltration. The roof downspout is connected to the dry-well, allowing runoff to be stored and slowly infiltrated.

Characteristics

- Compact.
- Hidden from view, has no effect on aesthetics.

Applications

- Not appropriate for slopes >40% or areas with expansive soils.
- Many agencies have policies regarding dry wells because of concerns that include migration of pollutants into groundwater, or dumping of pollutants into drywell. Most jurisdictions permit drywells that are connected directly to roof downspouts and are less than ten feet deep. Check local regulations.

Design

- Confirm requirements with local municipal ordinances. These may include

overall depth, as well as setbacks from structures, property lines, water supply wells, groundwater level, septic drainfields, and sensitive areas.

- Dimension calculations assume:
 - 1) Total volume runoff generated by roof in a design storm (e.g. 10 year, 24-hour, etc.) must be stored or infiltrated by the system during the storm.
 - 2) Infiltration system empty at beginning of storm and full at end.
 - 3) Rainfall and infiltration rates constant for duration of storm, including a safety factor.
- Subgrade must be relatively permeable (not appropriate for clay).
- Requires excavation filled with drain rock and wrapped top, sides and bottom with filter fabric. Excavation is sized to accommodate water quality volume storm, accounting for 38-40% void space of gravel fill.
- A buried catch basin (concrete, plas-

tic, or metal) or large diameter pipe with open bottom set on end can be used to contain drain rock.

- Roof downspouts are attached to the dry well, an overflow pipe is provided for runoff in excess of water quality volume.
- Provide perforated observation pipe (such as a 6" diameter PVC) to allow for inspection and maintenance.
- Provide pre-treatment sedimentation basin for composite roofs. This can be a small plastic valve box with open bottom.

Maintenance

- Requires inspection at beginning of rainy season.
- Remove sediment from sedimentation basin prior to rainy season.

Economics

- Relatively inexpensive to construct and maintain.

Cistern

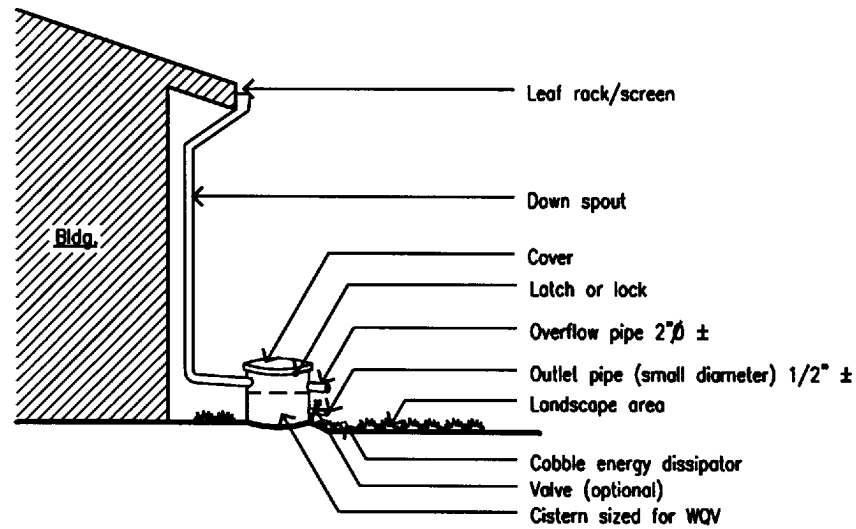

Conditions, dimensions, and materials shown are typical. Modifications may be required for proper application, consult qualified professional.

Cistern. A cistern is an above ground storage vessel that is directly connected with the roof downspout. Water is slowly released with either a manually operated valve or a permanently open outlet.

Characteristics

- Cisterns can be incorporated into the aesthetics of the building and garden. Japanese, Mediterranean and American southwest architecture provide many examples of attractive cisterns made of a variety of materials.
- Reduces peak runoff and allows sediment to settle.
- Provides more infiltration benefits than connecting directly to storm drain.

Applications

- Residential, commercial, office buildings.

Design

- Manually operated valve can be closed to store stormwater for irrigation use or infiltration between storms.
- Cistern must be covered to prevent mosquitoes from breeding.
- Permanently open outlet must be sized appropriately. If it is significantly smaller than the size of the downspout inlet (approx. 1/4 to 1/2 inch diameter), runoff will build up inside the cistern during storms, and will empty out slowly after peak intensities subside, mitigating the peak flow runoff from impervious rooftops, especially for the frequent, small storms.
- Size cistern for water quality volume, provide overflow for larger storms.

- Provide secure cover or ≤ 4 " top opening if holding more than 6" depth of water, to prevent small children from gaining access to the standing water.
- Provide screen on gutter and intake of outlet pipe to minimize clogging by leaves and other debris.

Maintenance

- System requires regular monitoring and cleaning.
- Maintenance required to ensure that system is not clogged by leaves or other debris.

Economics

- Low installation cost.

Foundation planting

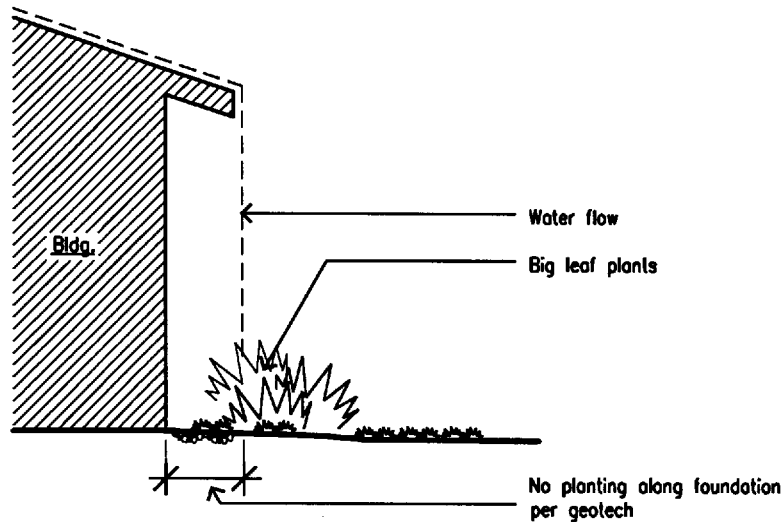

Conditions, dimensions, and materials shown are typical. Modifications may be required for proper application, consult qualified professional.

Foundation planting. Landscape planting around the base of the eaves can reduce the physical impact of water on the soil and provide a subsurface matrix of roots that encourage infiltration.

Characteristics

- Foundation planting serves function of to provides increased opportunities for stormwater infiltration.
- Planting protects the soil from erosion caused by concentrated sheet flow coming off the roof, reducing the amount of sediment in urban runoff.

Applications

- For buildings that do not use a gutter system.

Design

- Locate plants at the roof drip-line.
- Select plants with high capacity for vertical water storage.

- Select plants with leaf architecture that intercepts rainwater and traps it for eventual evaporation.
- Select plants sturdy enough to tolerate the heavy runoff sheet flows, and periodic soil saturation.
- Provide mulch cover in planting bed to protect soil from impact of falling rainwater and to increase soil water-holding potential.
- Protect perimeter of foundation as required by local soil conditions.

Maintenance

- Regular garden maintenance.

Pop-up drainage emitter

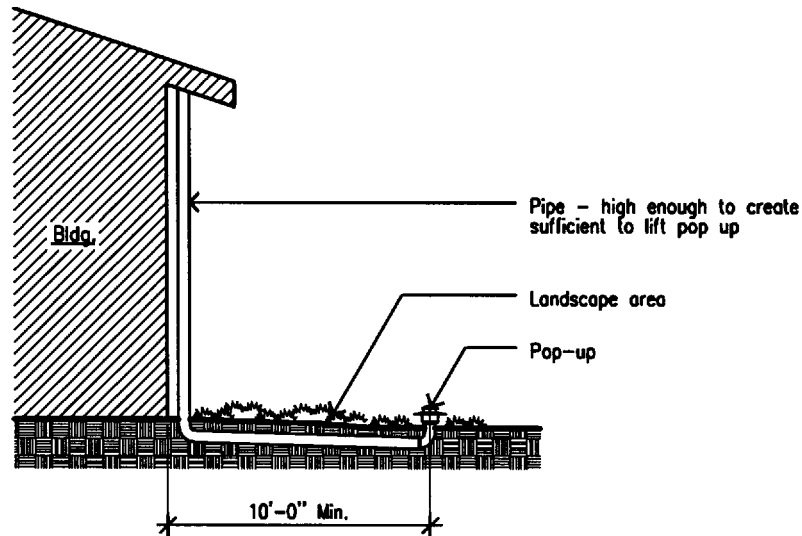

Conditions, dimensions, and materials shown are typical. Modifications may be required for proper application, consult qualified professional.

Pop-up drainage emitters allow water collected by downspouts and roof gutter systems to flow through a drainage pipe away from structural foundations, and “pop-up” to disperse in lawn or landscaped areas.

Characteristics

- Emitter is opened by the hydrostatic pressure flowing through the drain pipe. As flow diminishes, the emitter closes again.
- Blends into the surrounding landscape; appearance similar to standard pop-up sprinkler.
- Sheet flow of runoff allows for infiltration.

Applications

- Can use for water captured by standard gutter and downspout system, grates, catch basins, grates and drains.
- Can use to divert water away from erosion-prone or poor drainage areas.
- May be more effective in certain soil types.

Design

- Size emitter(s) according to downspout and watershed (roof area) size.
- Design pipe riser to height required to create head sufficient enough to lift pop-up.
- Design outfall to sheetflow onto vegetated area (such as lawn or groundcover) or suitable landscaped or paved infiltration and drainage system.

Maintenance

- Standard maintenance practices can be used.
- Emitter is only open when water is flowing through the drain pipe, minimizing the risk of debris and rodents entering the pipes.

Economics

- Emitter unit cost \$12-20 each plus pipe.

Examples/resources

- City of Milpitas has info. on the sq. ft. of landscape required per sq. ft. roof.

8.6 Landscape

Landscape solutions for stormwater quality combining site engineering – grading and drainage – with landscape architecture. This presents an opportunity for civil engineers and landscape architects to cooperate on the designs for integration of function and aesthetics.

One concern among developers and property owners is that landscape stormwater infiltration and detention areas will become subject to government regulation as wetlands after they are established.

According to the California Regional Water Quality Control Board, these landscape areas are not classified as jurisdictional wetlands subject to mitigation if their land use is later changed, as long as:

- *the design elements (e.g., swales, ponds) are clearly identified on plans and documentation as stormwater treatment areas (BMPs),*
- *the design elements are not used as mitigation for impacts to other wetlands, and*
- *the design elements do not impact or replace existing wetlands.*

Landscape

Grass/vegetated swales

Extended detention (dry) ponds

Wet ponds

Plant species selection for infiltration areas

Grass/vegetated swales

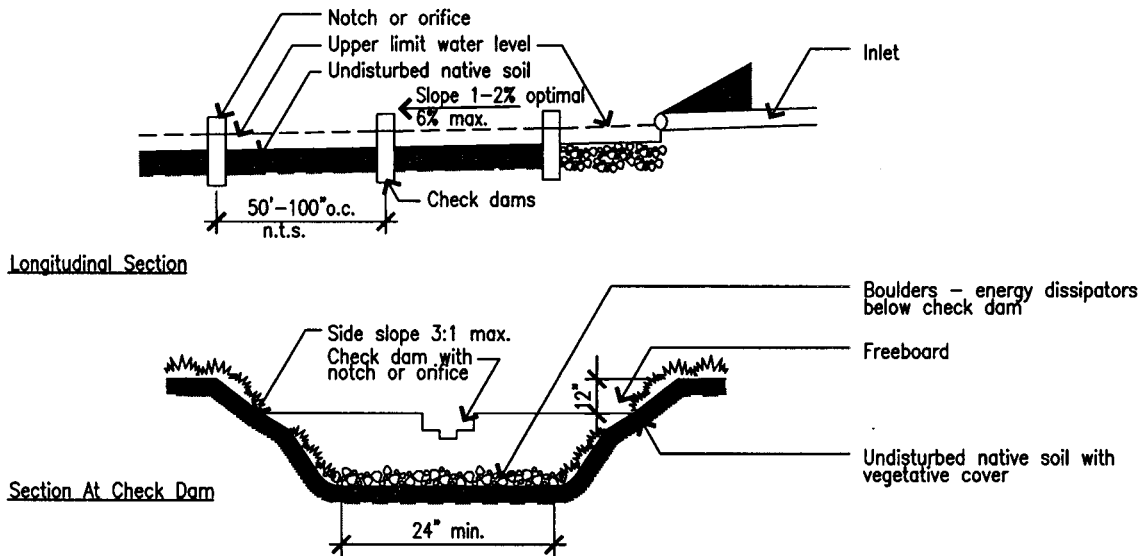

Conditions, dimensions, and materials shown are typical. Modifications may be required for proper application, consult qualified professional.

Grass/vegetated swales. An alternative to lined channels and pipes, grass and vegetated swales are vegetated earthen channels that convey and infiltrate water and remove pollutants.

Characteristics

- If properly designed and maintained, swales can last for at least 50 years.
- Can be used in all types of soil. In clay or impermeable soils, swale may require an underdrain to keep maximum water residence time below 24 hours. In sandy or highly permeable soils, swale may require soil amendments to maintain dense turf or vegetation.
- When swales are not holding water, they appear as a typical landscaped area.
- Pollutants and water are filtered by grass/vegetation and removed by infiltration into soil.
- Swales remove suspended solids, the pollutants that are adsorbed onto the

solids (including heavy metals and nutrients), oil and grease.

Applications

- Swales require approx. 1200 square feet minimum per impermeable acre (i.e., they will occupy an area equal to at least 2.75% of site's total impermeable area)
- A single grassy swale can drain approximately 4 acres of land. Multiple swales would be required to drain a larger site.
- Parking lot medians, perimeters of impervious pavements.
- Street and highway medians, edges (in lieu of curb and gutter, where appropriate).
- In combination with constructed treatment systems or sand filters.

Design

- Grass swales move water more quickly than vegetated swales. A grass swale is planted with turf grass; a vegetated swale is planted with bunch grasses, shrubs or trees.

- Pollutant removal effectiveness can be maximized by increasing residence time of water in swale.
- Incorporate systems that temporarily divert flows to allow for maintenance.

Longitudinal slope Optimal longitudinal slope is approximately 2% at bottom of the swale. Low slopes reduce public hazards and limit erosion by reducing water velocities and increase pollutant removal by increasing residence time.

For slopes $\leq 1\%$, install an underdrain to limit standing water in swale.

Install check dams approximately every 50 to 100 feet on slopes between 4% and 6% to reduce velocity.

Do not use swales on slopes greater than 6%.

Installing turf block bottoms on grass swales can minimize wet, muddy con-

Grass/vegetated swales, continued

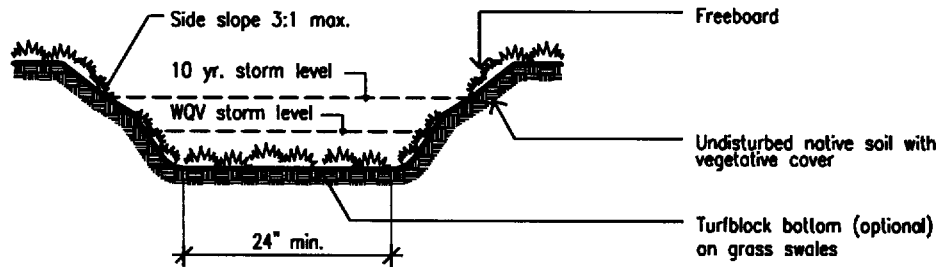

Typical Section

Conditions, dimensions, and materials shown are typical. Modifications may be required for proper application, consult qualified professional.

ditions that hinder maintenance activities.

Side slope 3:1 (horizontal:vertical) or shallower, to limit erosion and to improve maintainability.

Residence time 9 minutes achieves approximately 80% removal of total suspended solids (TSS).

Inlet Sheet flow or multiple dispersed inlets are better than a single inlet.

If a single inlet (pipe or curb cut) is necessary, design an energy dissipator and flow spreader (such as cobbles or gravel) where water enters the swale to reduce erosion and maintenance.

Planting Select plant species that can survive through both periods of inundation and periods of drought.

A variety of grass species, including native and non-native, can together produce a swale turf that is adapted to varying site environments (see table).

Both trees and shrubs can be located adjacent to swales, and on the banks of larger swales.

If planted with turfgrass, provide supplemental irrigation, to keep swale green year round.

Establishment If establishing vegetation during the dry season, it must be planted at least one month prior to the beginning of the rainy season and irrigated to promote establishment until regular rains begin.

If establishing vegetation during the wet season, divert stormwater runoff from the swale during the first rainy season in which the vegetation is being established.

Erosion control measures such as netting or blankets may be used to aid establishment.

Mosquito prevention Design for maxi-

mum residence time of 24 hours (mosquitoes generally require 48 hours to breed and hatch).

Maintenance

- Grass swale maintenance includes mowing and removing clippings and litter; vegetated swales may require additional maintenance of plants.
- Periodically remove sediment accumulation at top of bank, in swale bed, or behind check dams.
- Monitor for erosion and reseed grass or replace plants, erosion control netting and mulch as necessary.
- Fertilize and replace turf well in advance of rainy season to minimize water quality degradation.

Economics

- Grass swale construction cost per linear foot \$4.50-\$8.50 (from seed) to \$15-20 (from sod), compare to \$2 per inch of diameter underground pipe

e.g., a 12” pipe would cost \$24 per linear foot).

- \$0.75 annual maintenance cost per linear foot

Examples/resources

- 10.9 acre site drains parking lot and roof runoff into swales. BT Office Supply Warehouse, 6601 Overlake Place, Newark, CA.
- Parking lot and roof runoff drains to swale at office building. 3150 Porter Drive, Palo Alto, CA.
- Santa Clara Valley Water District offices. 5750 Almaden Blvd., San José, CA.
- Landscape Architecture Technical Information Series (LATIS), *Vegetated Swales*, 1999.

Grass species for swales

There are many alternatives to conventional turfgrass suitable for use in vegetated swales.

Scientific Name	<i>Festuca rubra</i> †
Common Name	Molate/Red fescue
<i>Agrostis exarata</i> †	<i>Hordeum brachyantherum</i> †
Bentgrass	Meadow barley
<i>Bromus carinatus</i> †	<i>Hordeum brachyantherum salt</i> †
California Brome	Meadow barley salt
<i>Buchloe dactyloides</i>	<i>Juncus spp.</i>
Buffalo Grass	Rushes
<i>Elymus triticoides</i>	<i>Stipa pulchra</i> †
Creeping wildrye	Purple needle grass
<i>Festuca idahoensis</i>	<i>Vulpia myuros v. hirsuta</i> †
Idaho fescue, Blue bunchgrass	Zorro annual fescue

† *California native*

Extended detention (dry) ponds

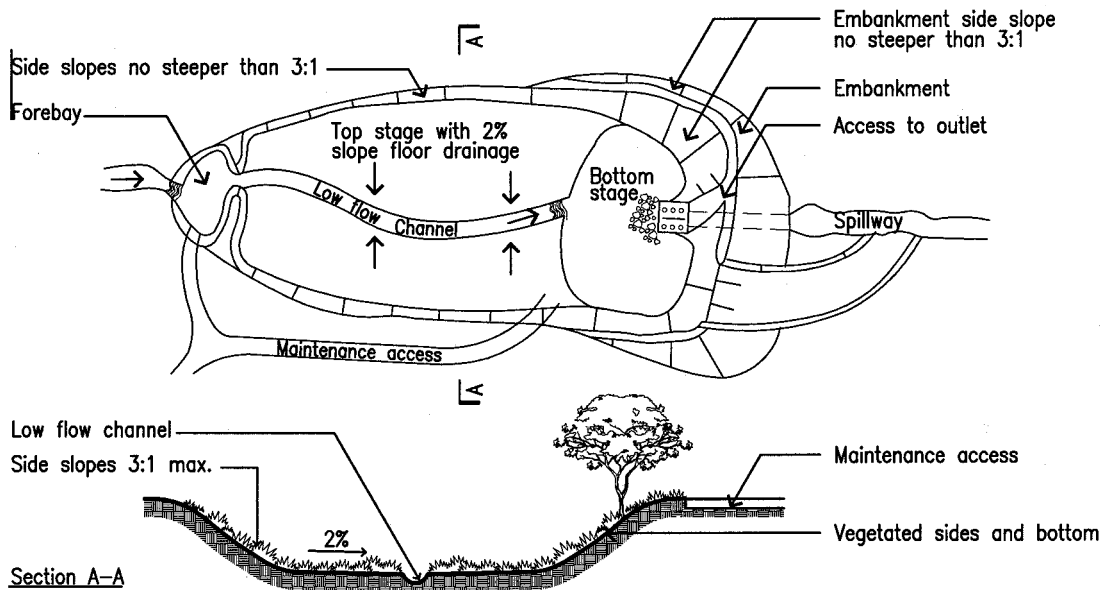

Conditions, dimensions, and materials shown are typical. Modifications may be required for proper application, consult qualified professional.

Extended detention (dry) ponds store water during storms for a short period of time (from a few hours up to a few days), and discharge water to adjacent surface waters. They are *dry* between storms, and do *not* have a permanent pool of water.

Characteristics

- If properly designed, ponds can have a lifetime of 50 years.
- Clay or impervious soils should not affect pollutant removal effectiveness, as the main removal mechanism is settling.
- Pollutants removed primarily through gravitational settling of suspended solids, though a small portion of the dissolved pollutant load may be removed by contact with the pond bottom sediments and/or vegetation, and through infiltration.
- Moderate to high removal of suspended solids (sediment) and heavy metals.

- Low to moderate removal of nutrients and Biological Oxygen Demand (B.O.D.).
- Pollutant removal can be maximized by increasing residence time (average 24 hours); two-stage pond design, with the addition of wetland vegetation to lower stages of the pond; sediment-trapping forebay to allow efficient maintenance; regular maintenance and sediment cleanout; installing adjustable gate valves to achieve target detention times; designing pond outlet to detain smaller treatment volumes (less than two-year storm event).

Applications

- May be initially used as construction settling basins, but must be regraded and cleaned out before used as a post-construction wet pond.
- May be designed for both pollutant removal and flood control.
- May be appropriate for developments of 10 acres or larger.

- Potential for multiple uses including flood control basins; parks, playing fields, and tennis courts; open space; overflow parking lots.

Design

- Coordinate pond design, location, and use with local municipal public works department and/or county flood control department to reduce potential downstream flooding.
- Default conditions for safety have been to fence basins with chain link. Consider aesthetic design elements with safety analyst to address pond barriers, such as fencing and/or vegetation, and shallow side slopes (8:1 to 12:1).

Residence time Design pond for an average residence time of 24 hours, with a maximum of 40 hours.

Slopes Inside basin slopes should be not greater than 3:1 (horizontal:vertical), to minimize erosion and allow heavy equipment access for periodic cleanout.

Inlet Design energy dissipation at the inlet to minimize erosion and promote settling in the forebay. A trash rack can be installed at the inlet to capture large debris before it enters the basin.

Outlet Vertical risers, negatively sloped pipes, and perforated pipes in a gravel bed are all methods of discharging water from the pond. Vertical risers have the advantage of being less susceptible to clogging.

Vegetation Vegetation can enhance pollutant removal and the aesthetic appearance of extended detention ponds. Specify emergent wetland vegetation and non-wetland plants tolerant of inundation.

Mosquito prevention Minimize pond area that has a depth less than 18 inches.

Use foundation aeration to limit periods of still water during detention.

Plant emergent vegetation with minimal submerged growth.

Apply *Bacillus* (Bti) or other bacteria.

Maintenance

- Regular inspection during wet season for sediment buildup and clogging of inlets and outlets (designing forebay to trap sediments can decrease frequency of required maintenance, as maintenance energy is concentrated towards a smaller area of the basin, and less disruptive than complete cleaning).
- Clean inlet trash rack and outlet standpipe as necessary.
- Clean out basin sediment approximately once per year (this may vary depending on pond depth and design, and if forebay is used). Once site is stabilized, annual cleaning will not likely be needed.
- Mow and maintain pond vegetation, replant or reseed as necessary to control erosion.

Economics

- Least expensive stormwater quality pond option available. 0-25% additional cost when added to conventional stormwater detention facilities.
- Construction cost \$0.10-\$5.00 per cubic foot of storage (savings from preparing silt basins used during construction for use as extended detention ponds).
- Maintenance cost 3-5% of construction cost annually.

Wet ponds

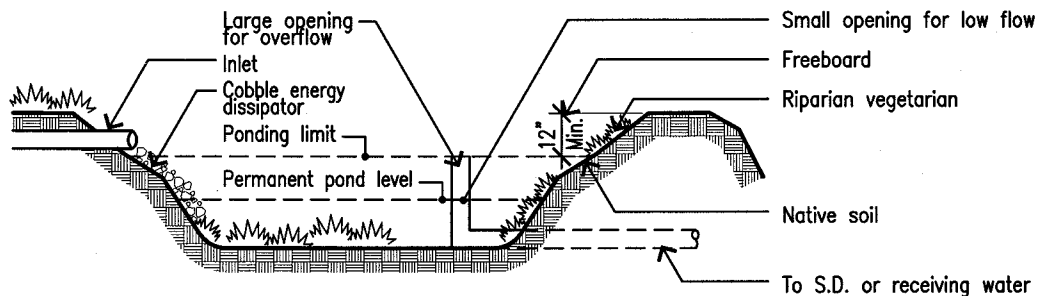

Conditions, dimensions, and materials shown are typical. Modifications may be required for proper application, consult qualified professional.

Wet ponds are permanent pools of water that detain and treat stormwater runoff. They can be enhanced by designing a forebay to trap incoming debris and sediment, and by establishing a fringe wetland at the pond edge to increase pollutant removal and enhance the aesthetic, economic, and habitat value of the pond.

Characteristics

- If properly designed, wet ponds can last indefinitely.
- Clay or impervious soils should not affect pollutant removal effectiveness, as the main removal mechanism is settling.
- Can increase property values by providing a significant landscape amenity.
- Wet ponds provide moderate to high removal of most urban stormwater pollutants, including total suspended solids, sediment, heavy metals, phosphorus, nitrogen, and B.O.D. Removal rates are dependent on residence time

of water in pond, amount of wetland vegetation fringing the pond, and other factors.

- Pollutants are removed by settling suspended solids, uptake by wetland plants and algae, and bacterial decomposition.

Applications

- Wet ponds are appropriate for stormwater drainage in a development or project with a drainage area greater than approximately 2 acres, but are more cost effective for drainage areas greater than 10 acres.
- Landscape amenity in residential or commercial development with opportunities for passive recreation (e.g., birdwatching, fishing, boating), and can be combined with consideration to pedestrian and bicycle circulation to provide active recreation.
- May be initially used as construction settling basins, but must be regraded and cleaned out before used as a post-construction wet pond.

Design

- Coordinate pond design, location, and use with local municipal public works department and/or county flood control department to reduce potential downstream flooding.
- Pretreatment may be needed to remove trash, debris and sediments and to reduce maintenance.
- For risk management, basins area often fenced. Other alternatives to minimize risk include screening vegetation and shallow side slopes (8:1 to 12:1).

Area Surface area must equal 1% of the drainage area for high pollutant removal (e.g. 100 acre drainage area would require a 1 acre wet pond).

Storage volume Design permanent pool to store 0.5-1.0" of runoff per contributing watershed area (a storage volume of 1.0" of runoff per contributing watershed area in the Bay Area will capture and treat the runoff from about 75-85% of the rainstorms each year).

Residence time In general, pollutant removal increases as residence time increases. Pollutant removal can be accomplished with a few days of residence time. The California Stormwater BMP Handbook: Municipal recommends that removal of very fine sediments and removal of dissolved nutrients by plants requires a minimum residence time of 14 days.

Side slopes Forebay side slopes 4:1 to allow access for heavy equipment for periodic cleanout and sediment removal.

Permanent pool side slope 4:1 or shallower if wetland vegetation will be planted around the edge. Shallower slopes will also increase safety and wildlife habitat value.

Depth Range from 3 to 9 feet maximum. A depth greater than 9 feet may produce odor generated from depletion of oxygen in bottom sediments.

Length to width ratio Minimum 3:1 length:width ratio, baffles separating inflow and outflow pipes, and small islands will help avoid flow short circuiting.

Inlet and Outlet Energy dissipation should be used to minimize erosion and promote settling in the forebay.

A weir overflow should be used to pass high-return period (50- or 100- year) flows through the pond and to avoid erosion and flooding.

Vegetation Wet ponds may be constructed with or without a fringe wetland. If fringe wetland is not used, inundation-tolerant grass or other vegetation may be used on the banks. However, this will lower pollutant removal and wildlife value. Wet pond vegetation should consist of wetland plants, including emergent plants, and non-wetland plants tolerant of inundation.

Where fringe wetlands are used, wetland vegetation should occupy 25-50% of the pond surface area to enhance pollutant removal.

Establish vegetation with irrigation 6 months prior to the rainy season, to stabilize the wet pond prior to the rainy season. If this is impossible, appropriate erosion control measures such as blankets, matting, or mulch may be used.

Maintenance

- Check facility annually and after each major storm for erosion and debris.
- Approximately every 2-5 years (when 10-15% of storage volume has been lost), remove sediment from forebay and main pool. Studies generally indicate that pond sediments meet sludge toxicity limits and can be safely disposed of as normal landfill.
- Replant or reseed as necessary to control erosion.
- Provide supplemental water in summer, if required.

Economics

- Construction cost: \$0.50-\$1.00 per cubic foot of storage.
- Annual maintenance cost is approximately 5% of capital cost for <100,000 cubic feet of storage; 3% for 100,000-1,000,000 cu. ft.; 1% for >1,000,000 cu. ft.

Examples/resources

- Ponds planned to receive summer dry weather flows from landscape irrigation and car washing uses in residential development. Basking Ridge, San José CA.
- West Davis Ponds, Davis, CA.
- Parking lot and structure runoff drain to wet pond in strip mall development. South Napa Marketplace, Napa CA.

Plant species selection for infiltration areas

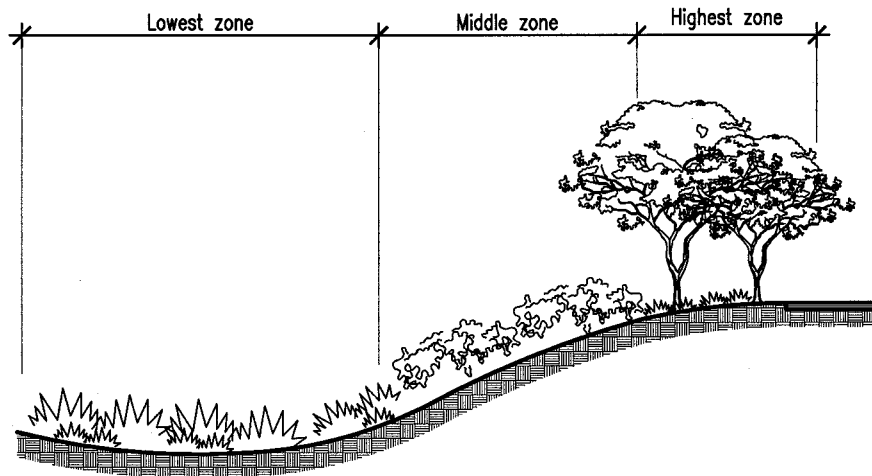

Conditions, dimensions, and materials shown are typical. Modifications may be required for proper application, consult qualified professional.

Plant species selection for infiltration areas can improve the infiltration potential of landscape areas as well as improve the aesthetics of design.

Characteristics

- Deep rooted plants help to build soil porosity.
- Leaf surface-area helps collect rainwater before it lands on the soil, especially in light rains, increasing the overall water holding potential of the landscape.
- Select species that are tolerant of moist soils or periodic inundation, as well as drought if planted without supplemental irrigation.

Applications

- Applicable to all treatment devices that incorporate plant materials.

Design

- Select appropriate plant species depending on zone of inundation: lowest, middle, and highest.
- Most plants and grasses require initial irrigation during establishment period,

as well as during dry periods.

- Select the appropriate plant for the use, water cycle, and aesthetic goals.
- Consider sight-line and other requirements for parking lots and street-side plantings.
- Include mulch cover in planting areas.

Maintenance

- Maintenance can have a significant impact on soil permeability and its ability to support plant growth. If the soil is exposed or bare, it can become so hot that surface roots will not grow in the upper 8 to 10 inches, where the majority of small absorbing roots lie. The common practice of removing all leaf litter and detritus with leaf blowers creates a hard crusted soil surface of low permeability and high heat conduction. Proper mulching of the soil surface improves water retention and infiltration, while protecting the surface root zone from temperature extremes.

- Slightly more attention to maintenance and care of plant material may be required than in non-infiltration areas.

Economics

- Riparian and native plant material species are approximately 20% more expensive to purchase than common landscape species.
- Changing from the leaf blower maintenance practice to more manual practices may increase labor cost.

Plant Species for Infiltration Areas

Most infiltration and detention basins are designed to remain inundated for less than 48 hours (drawdown time). The following trees and shrubs tolerate wet soil and periodic inundation, and may be suitable for planting in basins and biofilters depending on regional hardiness and other factors. This list is not all-inclusive, and draws from both native and exotic species. Local riparian habitats may provide additional native species suitable for wet locations.

Highest Zone

<i>Acer negundo</i>	Box Elder
<i>Acer rubrum</i>	Red Maple
<i>Acer saccharinum</i>	Silver Maple
<i>Alnus spp.</i>	Alder
<i>Betula spp.</i>	Birch
<i>Carya illinoensis</i>	Pecan
<i>Carya ovata</i>	Buttonbush
<i>Casuarina spp.</i>	She-Oak
<i>Clethra arborea</i>	Lily-of-the-Valley
<i>Cornus stolonifera</i>	Redtwig Dogwood
<i>Diospyros virginiana</i>	Persimmon
<i>Eucalyptus camaldensis</i>	Red Gum
<i>E. citriodora</i>	Lemon Gum
<i>E. erythrocorys</i>	Red-Cap Gum
<i>Fraxinus latifolia</i>	Oregon Ash
<i>Gleditsia triacanthos</i>	Honey Locust
<i>Liquidambar styraciflua</i>	Liquidambar
<i>Liriodendron tulipifera</i>	Tulip Tree
<i>Magnolia grandiflora</i>	Southern Magnolia
<i>M. virginiana</i>	Sweet Bay
<i>Melaleuca quinquenervia</i>	Cajeput Tree
<i>Nyssa sylvatica</i>	Tupelo
<i>Picea sitchensis</i>	Sitka Spruce
<i>Platanus x acerifolia</i>	London plane
<i>Platanus occidentalis</i>	Sycamore
<i>P. racemosa</i>	California Sycamore
<i>Populus deltoides</i>	Cottonwood
<i>Pterocarya stenocarpus</i>	Wingnut
<i>Quercus macrocarpa</i>	Bur Oak
<i>Q. palustris</i>	Pin Oak

<i>Salix spp.</i>	Willow
<i>Sequoia sempervirens</i>	Coast Redwood
<i>Taxodium distichum</i>	Bald Cypress
<i>Thuja occidentalis</i>	Arborvitae

Middle Zone

<i>Cornus stolonifera</i>	Redtwig Dogwood
<i>Gaultheria shallon</i>	Salal
<i>Equisetum hyemale</i>	Horsetail
<i>Ferns (many spp.)</i>	Fern
<i>Iris (many spp.)</i>	Iris
<i>Mimulus</i>	Monkeyflower
<i>Miscanthus sinensis</i>	Japanese Silver Grass
<i>Myoporum parvifolium</i>	Myoporum
'Putah Creek'	
<i>Myrica</i>	Pacific Wax Flower
<i>Salix spp.</i>	Willow
<i>Vaccinium</i>	Huckleberry

Lowest Zone

<i>Acorus gramineus</i>	Acorus
<i>Carex spp.</i>	Sedge
<i>Deschampsia caespitosa</i>	Tufted Hairgrass
<i>Iris (many spp.)</i>	Iris
<i>Leucothoe davisiae</i>	Sierra Laurel
<i>Scirpus cernuus</i>	Bulrush
<i>Juncus spp.</i>	Rush
<i>Tradescantia virginiana</i>	Spiderwort
<i>Typha latifolia</i>	Common Cattail

Table adapted from Harris (1992), *Sunset Western Garden Book* (1988), and *ABAG* (1995b)

9 Next Steps

This document illustrates an approach and philosophy towards site planning and design for stormwater management. The design details and site planning principles presented here are proven, practical methods for reducing the impact of new development on environmental quality.

This approach seeks to restore the hydrologic cycle by infiltrating runoff into the soil as close to its source as possible. It proposes simple site planning principles to cluster development, preserve natural areas, and avoid development on fragile lands. It accepts impervious land coverage as an environmental indicator, and seeks to maximize the permeability of new development. It aims to achieve all these objectives economically while creating communities that are more beautiful and desirable places to live.

The document has one goal: to create better projects. Because of the complex nature of development, this goal can only be achieved if developers, regulatory agencies, local governments, designers, contractors, maintenance staff, and others in the real estate industry work cooperatively.

Each group active in development can take a series of steps to create better projects.

Next Steps

9.1 Frequently asked questions

9.2 Getting started

9.3 Keys to success

9.4 Resources

Communities can be built that reward investment, are kind to the natural environment, and make better places for people to live.

9.1 Frequently asked questions. The techniques described in this document have three basic goals:

- to minimize or reduce overall impervious land coverage,
- to ensure that remaining impervious areas are not directly connected to a storm drain system as far as feasible, and
- to slow runoff within a drainage system.

Because this approach is different than the conventional stormwater management approach of conveying water offsite as quickly as possible – “getting rid of the water” – it often raises questions. A few of the most frequently asked questions are addressed below.

If pollutants infiltrate into the soil, will there be a problem with contaminated soil or groundwater in the long term?

Not usually, especially in residential areas. The risk of contamination is a function of a compound’s relative mobility, concentration, and solubility. In residential areas, the concentrations of most pollutants are generally low, and capturing them in the ground where they will eventually degrade is usually the best way to manage them. A recent study published by the U.S. EPA found that residential areas pose the least risk of groundwater contamination from infiltration practices. This study found that the risk from compounds with greatest potential for groundwater pollution – nitrate-nitrogen, pesticides, organic compounds and heavy metals – was generally low provided that runoff percolates through the soil layer. Runoff from some sites in residential communities with higher concentrations of pollutants, such as car wash facilities and service stations, may not be suitable for infiltration.

If water is standing in pools, won’t they breed mosquitoes?

Not if the pools are properly designed. All of the techniques described in this document that utilize surface drainage – such as infiltration basins, biofilters, and detention basins – can be designed to dry up within 48 hours of a storm. Even an extended retention basin, which is a semi-permanent pool that holds water for two or three weeks, should be designed to dry up in the spring before temperatures are warm enough to breed mosquitoes.

What about expansive clay soils that don’t infiltrate?

The Bay Area’s expansive clay soils – with their high runoff potential and low infiltration rates – present special challenges. Also, because these soils have a high swelling potential, care must be taken to prevent damage to foundations from saturated soils. Though infiltration may not be feasible, retention and detention strategies that hold water for later release are often practical. Minimizing impervious land coverage and directly-connected impervious areas are also viable strategies, even in expansive clay soils.

You recommend reducing street widths by adopting “neo-traditional” standards. How is that going to help?

The street is the single most important design element in site planning. Reducing street widths can reduce overall impervious land coverage significantly. For example, most Bay Area municipal street standards mandate between 80 and 100% impervious surface coverage in the right-of-way for streets, curb, gutter and sidewalk. If new standards are adopted for the most lightly traveled local streets, impervious surface coverage can be reduced by 25 to 60%. This alone helps to reduce the generation of “new” runoff from a proposed development. If the street design includes alternative stormwater collection strategies, such as linear biofilters and infiltration basins rather than standard catch basins and storm drains, the pollution generated by vehicles can be controlled near its source.

What about cost? Aren’t these designs expensive to build?

These designs emphasize source control because it’s the cheapest form of pollution control. Treatment control systems – collecting pollutants and treating them at the end of a pipe before the outfall – are more expensive to build and maintain, and require treating greater quantities of runoff.

Of the source control designs illustrated here, costs vary. Some designs, like concave vegetated surfaces or sloping driveways towards adjacent landscape rather than towards curbs and gutters, are cost neutral. Others, like gravel parking aisles, are less costly than conventional pavements. Cluster development, a

Frequently asked questions, continued

strategy for minimizing overall impervious land coverage, can be less expensive than conventional development because of reductions in roadway and utility requirements. Some of the techniques, such as pervious concrete, do add cost when compared to conventional materials, but these costs can sometimes be offset by savings generated by not having to install an underground drainage system.

Aren't these designs more expensive to maintain? And who's responsible for maintaining them, anyway?

Though some of the design details need special maintenance, many of them don't. For example, a lawn with a gently sloping concave surface requires the same maintenance as one that is convex. Yet the concave lawn holds water, making it a stormwater management device, while the convex lawn sheds water, making it a contributor to "new" runoff. Overall, the maintenance requirements of the designs recommended here can be comparable to conventional practice, though they may require a different kind of maintenance.

Maintenance responsibility will depend on the control's design and location. Some controls located on private property, such as a dry well or concave lawn near a home, will be maintained by the homeowner. Other controls, such as swales or basins along streets or in parks, may be maintained by a public agency. Still others may be the responsibility of a homeowner's association or management company. In all cases adequate maintenance and proper education are critical to the long-term viability of each control. Once people understand the design intent of a control, and are given guidance on its proper maintenance, acceptance increases and maintenance effort can be optimized.

What about liability?

Compared to building large, single detention basins, the approach described in these pages minimizes risk. By minimizing impervious surface coverage and creating multiple, small basins in the landscape, overall runoff is reduced, and the runoff that remains is held in small, shallow pools for limited periods of time. These small source controls, if properly designed and maintained, present very limited risk.

For example, Village Homes, in Davis, California was built in the mid-1970s using a surface drainage system that includes infiltration basins in private gardens, community lawns and children's playgrounds connected by a continuous network of seasonal swales and pools. For over twenty years this system has functioned successfully in a residential environment with no injuries or litigation associated with the storm drain system.

Where can I get more copies of this manual?

Call your local stormwater program (see Resources, p. 154). They can get you more copies of this manual and help you to implement its design philosophy into your project.

I need more technical information. Where can I get it?

This document contains general technical information and design guidance. For more technical information, see the Resources section and the bibliography.

9.2 Getting Started. The following lists illustrate the wide range of options available that each of the groups active in development can take to begin implementing guidelines for better site planning and design. The lists are not meant to be mandates or all-inclusive, but to serve as a menu for each community to select from depending upon priorities, resources, and local conditions.

Regulatory agencies

- promote education and exchange of information on stormwater management
- create a regulatory environment that facilitates the implementation of better stormwater management practices
- assist local governments in the monitoring and evaluation of alternative stormwater management practices
- recognize and reward projects that take risks and that embrace better stormwater management practices.

Local governments

- adopt standards and alternatives for design and stormwater management, such as impervious surface reduction and on-site stormwater infiltration or detention
- establish an incentive program to encourage alternatives that achieve water quality goals
- establish a penalty program for projects that do not achieve water quality goals
- adopt access street standards for low volume, access streets
- adopt drainage standards and details that permit surface drainage and infiltration/retention systems in combination with conventional underground conveyance systems
- review zoning and other ordinances for driveways, setbacks, lot coverage, and other factors to accommodate more environmentally responsible land use
- modify maintenance practices on public lands and in the public right-of-way to accommodate stormwater infiltration/detention systems
- build a culture of environmental stewardship across all departments and offices

- use these principles and techniques in siting and designing government facilities.

The building industry

- think of water as an amenity to be featured rather than a liability to be gotten rid of or a hazard from which the public must be protected
- market the stormwater system as a landscape feature that can improve product competitiveness
- explore techniques that have proven successful elsewhere, but have not yet been widely used in the Bay Area
- work cooperatively with local governments to build prototype projects that demonstrate better stormwater management practices
- invest in designs and materials that may have a higher initial cost, but that yield long-term value
- educate landscape crews on maintenance practices for stormwater infiltration systems and soil health
- exhibit a willingness to take risks in order to advance the industry and improve the environment.

Design professionals

- invest in continuing education to learn about better stormwater management practice and design
- educate clients and approval bodies on the principles and advantages of designing developments for better stormwater management
- test designs and approaches to ensure successful implementation
- conceive of the drainage system as a fundamental design element to be creatively explored
- complete post-construction review of built projects to evaluate long-term performance of stormwater system designs
- practice continuous incremental improvement of stormwater system designs and detailing.

9.3 Keys to success. Site planning and design for stormwater management involves the coordination of many disciplines and activities. Building successful projects requires careful follow-through from concept to design to construction and maintenance.

Conceptual stage

- be sure to understand site constraints, local microclimates, and soil conditions
- determine regulatory environment and which particular design strategies are favored by regulatory agencies
- have a preliminary meeting between the development team and local government officials to discuss overall stormwater management goals and strategies
- consult local stormwater program to learn what has worked (and what hasn't) in a local area.

Design stage

- establish a stormwater management awareness among all disciplines in the design team
- hold regular cross-discipline coordination meetings to evaluate overall stormwater management solutions as design develops
- consult with local nursery person or horticulturist to determine appropriate plant material selection for the site's microclimate
- verify that stormwater systems are sized appropriately for the given water quality volume, and that residence time will be within acceptable limits
- carefully coordinate related design elements, especially
 - underground utilities and surface drainage
 - curb cuts and catch basins
 - materials and pavement selection
 - downspouts, area drains and roof drains
 - grading of roads, parking and adjacent landscape areas
- check proposed stormwater solutions with geotechnical engineer to verify suitability given site soil conditions

Construction documents stage

- ensure details and specifications are coordinated across disciplines (e.g. civil engineering and landscape architecture)
- if plans call for unconventional detailing, such as notched curbs or porous asphalt, be sure they are clearly and boldly identified on the drawings as different from conventional details (or contractor may not notice the difference)
- double-check all calculations for proper sizing and function
- if using manufactured products, such as turf block or catch basin inserts, take advantage of manufacturer's design consultation services, if available

Construction stage

- hold a pre-bid meeting with all contractors to review principal design elements and site conditions
- hold a pre-construction meeting with selected contractor to review construction documents in detail, especially details that differ from those conventionally used
- explain to the contractor the design intent of the various stormwater management designs— if they understand why something is designed a certain way, they are more likely to build it the way it's designed
- insist on meeting with the job foreman, not just the contractor's estimator or client service representative— the foreman will be the one actually supervising the work
- make periodic site visits during construction to ensure that designs are being correctly implemented

Post-construction stage

- hold a project closing meeting with the contractor to verify that designs were correctly implemented and to learn how they could be improved
- hold a meeting with the owner or the owner's maintenance staff to explain the stormwater system
- provide the owner and the maintenance staff with a Management Handbook describing how the stormwater system is designed to work and how to maintain it
- make post-occupancy visits to evaluate long-term performance

9.4 Resources. The following resources are available for further information and assistance with particular aspects of site planning and design for stormwater management protection.

Regional water resources and pollution prevention

Bay Area Stormwater Management Agencies Association (BASMAA)

1515 Clay Street, Suite 1400

Oakland, California 94612

voice: 510 622.2300

www.basmaa.org

Alameda Countywide Clean Water Program

510 670.5543

Contra Costa Clean Water Program

925 313.2360

San Mateo Countywide Stormwater Pollution Prevention Program

650 599.1406

Vallejo Sanitation and Flood Control District

707 644.8949

Fairfield-Suisun Urban Runoff Management Program

707 429.8930

Marin County Stormwater Pollution Prevention Program

415 485.3363

Santa Clara Valley Urban Runoff Pollution Prevention Program

800 794.2482

California Regional Water Quality Control Board

San Francisco Bay Region

1515 Clay Street, Suite 1400

Oakland, California 94612

510 622.2300

Central Valley Region

3443 Routier Road, Suite A

Sacramento, California 95827

916 255.3000

California Environmental Protection Agency

State Water Resources Control Board

901 P Street

Sacramento, California 95814

voice: 916 657.1025

fax: 916 657.2127

Local planning and development

Association of Bay Area Governments (ABAG)

P.O. Box 2050

Oakland, California 94604-2050

voice: 510 464.7900

fax: 510 464.7970

info@abag.ca.gov

Out-of-state planning and pollution prevention

Site Planning for Urban Stream Protection

available from Department of Environmental Programs

Metropolitan Washington Council of Governments

777 N. Capitol Street N.E., Suite 300

Washington, DC 20002

voice: 202 962.3200

The Center for Watershed Protection

8391 Main Street

Ellicott City, Maryland 21043

voice: 410 461.8323

New document for planning and zoning: *Rapid Watershed Planning Handbook: A Comprehensive Guide for Managing Urbanizing Watersheds*. October 1998.

Nonpoint Education for Municipal Officials (NEMO)
 Univ. of Connecticut Cooperative Extension System
 1066 Saybrook Road, Box 70
 Haddam, Connecticut 06438
 voice: 860 345.4511
 fax: 860 345.3357

Technical documents

California Storm Water Best Management Practice Handbooks
 Stormwater Quality Task Force (Roesner, Walker, et. al.).
 available through Blue Print Service, Oakland, CA.
 510 287.5485

Design and Construction of Urban Stormwater Management Systems
 American Society of Civil Engineers Manuals and Reports of Engineering Practice No. 77
 Water Environment Federation Manual of Practice FD-20
 jointly published by ASCE and WEF, 1992

Urban Runoff Quality Management
 WEF Manual of Practice No. 23
 ASCE Manual and Report on Engineering Practice No. 87
 jointly published by American Society of Civil Engineers (ASCE) and the Water Environment Federation (WEF)
 voice: (WEF) 703 684.2400
www.wef.org
www.asce.org

Stormwater Infiltration
 by Bruce K. Ferguson
 CRC Press
 Boca Raton, FL

Methodology for Analysis of Detention Basins for Control of Urban Runoff Quality
 Environmental Protection Agency (EPA-440/5-87-001)
 Washington, DC

Economic Benefits of Runoff Controls
 Environmental Protection Agency. (EPA 841-S-95-002)
 Washington, DC

Low-Impact Development Design Manual
 Department of Environmental Resources
 Prince George's County, Maryland

On-site Residential Stormwater Management Alternatives
 Dept. of Civil Engineering
 University of Washington
 3201 Fremont Avenue North
 Seattle, Washington 98103
 206 543.5539

Impervious Surface Reduction Study
 City of Olympia Public Works Department
 P.O. Box 1967
 Olympia, Washington 98507-1967
 voice: 360 753.8598
 fax: 360 753.8087

Time-Saver Standards for Landscape Architecture, second ed.
 by Charles W. Harris & Nicholas T. Dines, co-editors
 McGraw-Hill Publishing Company, New York, 1998.

Traffic Engineering for Neo-Traditional Neighborhood Design
 Institute of Transportation Engineers (ITE)
 525 School Street, S.W., Suite 410
 Washington, DC 20024-2729
 voice: 202 544.8050
 fax: 202 863.5486
www.ite.org

A Appendices

The following pages provide supplementary information for those seeking more detail on residential site planning and design guidance for stormwater quality.

The appendices were adapted from a variety of technical sources drawn from throughout the United States.

Appendices

A.1 Glossary. Relevant terms and acronyms used in the text and common to stormwater management issues.

A.2 Bibliography. A listing of relevant documents on site planning and design for stormwater management. These documents address a wide range of approaches to current practice, including engineering, environmental science, landscape architecture, planning, horticulture, real estate marketing and development.

A.3 Footnotes. References for information cited in the text.

Access streets The lowest order street in the hierarchy of streets, it conducts traffic between individual dwelling units and higher order streets (such as collector and subcollector streets). Access streets convey the lowest traffic volume, and are prime candidates for reduced street widths.

Alternative modes of transportation Modes of transportation other than the single passenger automobile, such as transit, bicycling, carpooling, and walking.

Alternative surfaces Pavement types other than conventional asphalt or concrete. Examples include porous pavement and pavers.

Amenity Something that increases material or physical comfort.

Aquifer The underground layer of rock or soil in which groundwater resides. Aquifers are replenished or recharged by surface water percolating through soil. Wells are drilled into aquifers to extract water for human use.

Arterial street A street that provides a direct route for long-distance travel within the region and also to different parts of the city. Traffic on an arterial street is given preference at intersections, and some access control may be considered in order to maintain capacity to carry high volumes of traffic.

Average daily traffic (ADT) The average total number of vehicles that traverse a road or highway on a typical day. Often used to classify and design roadway systems.

Best Management Practice A method, activity, maintenance procedure, or other management practice for reducing the amount of pollution entering a water body. The term originated from the rules & regulations developed pursuant to the federal Clean Water Act (40 CFR 1 30).

Bioretention A technique that uses parking lot islands, planting strips, or swales to collect and filter urban stormwater, that includes grass and sand filters, loamy soils, mulch, shallow ponding and native trees and shrubs.

Buffer A zone created or sustained adjacent to a shoreline, wetland or stream where development is restricted or prohibited

to minimize the negative effects of land development on animals and plants and their habitats.

Building footprint Commonly used term to describe the ground area that a building covers.

Catchment The smallest watershed management unit, defined as the area of a development site to its first intersection with a stream, usually as a pipe or open channel outfall.

Check dam (a) A log or gabion structure placed perpendicular to a stream to enhance aquatic habitat. (b) An earthen or log structure, used in grass swales to reduce water velocities, promote sediment deposition, and enhance infiltration.

Cluster Development A development pattern for residential, commercial, industrial, institutional, or combination of uses, in which the uses are grouped or “clustered,” through a density transfer, rather than spread evenly throughout the parcel as in conventional lot-by-lot development. A local jurisdiction’s Critical Area Program may authorize such development by permitting smaller lot sizes if a specified portion of the land is kept in permanent open space to provide natural habitat or open space uses through public or private dedication.

Collector street Acts as the primary traffic route within a residential or commercial area.

Constructed wetland An artificial wetland system designed to mitigate the impacts of urban runoff.

Contamination. The impairment of water quality by waste to a degree that creates a hazard to public health through poisoning or through the spread of disease.

Cul-de-sac A circular section located at the end of an access street that permits vehicles to turn around.

Curbs A concrete barrier on the margin of a road or street that is used to direct stormwater runoff to an inlet, protect pavement edges, and protect lawns and sidewalks from encroachment by vehicles.

Density The average number of families, persons, or housing units per unit of land, usually density is expressed “per acre”.

Design storm A rainfall event of specified size, intensity, and return frequency (e.g., a storm that occurs only once every 2 years) that is used to calculate runoff volume and peak discharge rate.

Detention The temporary storage of storm runoff which is used to control discharge rates sufficiently to provide gravity settling of pollutants.

Detention time The amount of time water actually is present in a basin. Theoretical detention time for a runoff event is the average time parcels of water reside in the basin over the period of release from the basin.

Drainage basin (see Watershed) A land area bounded by high points, which drains all surface water into a single stream or other body of water.

Effective Impervious Surface The portion of impervious surface that generates stormwater runoff which must be managed or directed to a stormwater conveyance system, rather than infiltrating into the ground.

Ephemeral stream A stream or waterway that holds water only for a few hours or days, and dries up shortly after rain storms.

Erosion The wearing away of land surface by wind or water. Erosion occurs naturally from weather or runoff but can be intensified by land-clearing practices related to farming, residential or industrial development, road, building, or timber cutting.

Evapotranspiration The loss of surface water into the atmosphere, through plants and evaporation.

Excess parking Parking spaces that are constructed over and above the number required or predicted based on the parking demand ratio for a particular land use or activity

Excess stormwater runoff Any increase in stormwater resulting from: an increase in the imperviousness of a site, including all additions to buildings, roads, and parking lots; changes in

permeability caused by compaction during construction or modifications in contours, including the filling or drainage of small depression areas; the alteration of drainageways, or regrading of slopes; the destruction of forest; or the installation of collection systems to intercept street flows or to replace swales or other drainageways.

Filter fabric Textile of relatively small mesh or pore size that is used to (a) allow water to pass through while keeping sediment out (permeable), or (b) prevent both runoff and sediment from passing through (impermeable).

Filter strips A vegetated area that treats sheetflow and/or interflow to remove sediment and other pollutants. Used to treat shallow concentrated stormflows over very short contributing distances in urban areas.

First flush The delivery of a disproportionately large load of pollutants during the early part of storms due to the rapid runoff of accumulated pollutants. The first flush of runoff has been defined several ways (e.g., one-half inch per impervious acre).

Forebay An extra storage space provided near an inlet of a wet pond or constructed wetland to trap incoming sediments before they accumulate in the pond.

Grassed channel A long, open, and grassed channel used to convey stormwater runoff to a downstream point. It is designed to filter out pollutants during water quality storms, and also convey large storm events.

Green space The proportion of open space in a cluster development that is retained in an undisturbed vegetative condition.

Groundwater Water stored underground that fills the spaces between soil particles or rock fractures. A zone underground with enough water to withdraw and use for drinking water or other purposes is called an aquifer.

Habitat The specific area or environment in which a particular type of plant or animal lives. An organism’s habitat must provide all of the basic requirements for life and should be free of harmful contaminants.

Hammerhead A “T” shaped turnaround option for lightly traveled residential streets. Creates less impervious cover compared to a circular cul-de-sac.

Headwater stream A term for the smaller first and second order tributary streams in a drainage network.

Heat island effect The increase in ambient temperatures generated by heat radiating from paved surfaces exposed to sunlight.

Hydrology The science of the behavior of water in the atmosphere (air), on the surface of the earth, and underground.

Impermeable Not able to be infiltrated by water.

Impervious surface Any surface which cannot be effectively (easily) penetrated by water. Examples include pavement, buildings, compacted soils, and rock outcrops.

Imperviousness The percentage of impervious cover within a development site or watershed.

Infill Developing vacant parcels or redeveloping existing property to achieve higher density in urban areas as an alternative to development in outlying rural areas.

Infiltration The downward entry of water into the surface of the soil, as contrasted with percolation which is movement of water through soil layers.

Infiltration basin A concave vegetated surface (e.g., pond, swale) designed to hold water so that it can gradually infiltrate into the soil.

Interconnected streets Street system that allows traffic to circulate within neighborhoods instead of creating cul-de-sacs and dead end streets that result in disconnected residential areas. A grid pattern of blocks is a typical example.

Nonpoint source pollution Pollution that enters water from dispersed and uncontrolled sources, such as rainfall or snowmelt moving over and through the ground rather than single, identifiable sources. A nonpoint source is any source of water pollution that does not meet the legal definition of point source in section

502(14) of the Clean Water Act (e.g., forest practices, agricultural practices, on site sewage disposal, automobiles, and recreational boats). While individual sources may seem insignificant, they may contribute pathogens, suspended solids, and toxicants which result in significant cumulative effects.

Non-renewable resources Resources that are not naturally regenerated or renewed.

Nonstructural control A practice that does not require construction of a facility to control urban runoff.

NPDES National Pollutant Discharge Elimination System, a provision of the Clean Water Act that prohibits discharge of pollutants into waters of the United States unless a special permit is issued by EPA, a state, or another delegated agency.

Open space A portion of a cluster development that is set aside for public or private use and is not developed with homes. The space may be used for active or passive recreation, or may be reserved to protect or buffer natural areas (see also green space)

Perennial streams A stream channel that has running water throughout the year.

Performance criteria Technical standards that govern the development process that are based on meeting general objectives for design, rather than prescribing rigid, uniform and detailed design requirements.

Permeable A type of soil or other material that allows passage of water or other liquid.

Permeable surfaces Areas characterized by materials that allow stormwater to infiltrate the underlying soils (e.g., soil covered or vegetated areas)

Pervious A soil or material that has the specific quality of allowing the passage of water or other liquid.

Point Source Pollution A source of pollutants from a single point of conveyance, such as a pipe. For example, the discharge from a sewage treatment plant or a factory is a point source.

Pollutants A chemical or other additive that adversely alters the

physical, chemical, or biological properties of the environment.

Porous pavement Asphalt or concrete paving material consisting of a coarse mixture cemented together with sufficient interconnected voids to provide a high rate of permeability.

Premium An additional charge for real estate property with an amenity such as a water view or a view of wooded land.

Receiving waters Lakes, rivers, wetlands, and coastal waters that receive runoff.

Recharge Area A land area in which surface water infiltrates soil and reaches to the zone of saturation, such as where rainwater soaks through the earth to reach an aquifer.

Recharge Infiltration of surface water to groundwater.

Retrofit To provide or add new equipment, parts, or techniques unavailable at the time of original construction.

Riparian Area Habitat found along the bank of a natural and freshwater waterway, such as a river, stream, or creek, that provides for a high density, diversity, and productivity of plant and animal species.

Runoff Water from rain, melted snow, or agricultural or landscape irrigation that flows over the land surface.

Runoff coefficient The runoff coefficient determines the portion of rainfall that will run off the watershed. It is based on the permeability and water-holding capacity of the various surfaces in the watershed. The runoff coefficient value, expressed as *C*, can vary from close to zero to up to 1.0. A low *C* value indicates that most of the water is retained for a time on the site, as by soaking into the ground or forming puddles, whereas a high *C* value means that most of the rain runs off rapidly.

Setback A zone designated to protect sensitive areas from negative impacts associated with development.

Shared parking A parking strategy designed to reduce the total number of parking spaces needed within an area, by allowing adjacent users to share parking areas during non competing hours of operation (e.g., a shared lot for a theater and an office

building).

Sheetflow A flow condition during a storm where the depth of stormwater runoff is very shallow in depth and spread uniformly over the land surface. This sheet flow quickly changes into concentrated channel flow within several hundred feet.

Steep slope An area of a development site that is too steep to (a) safely build on or (b) has a high potential for severe soil erosion during construction.

Stormwater conveyance A system of gutters, pipes, or ditches used to carry stormwater from surrounding land areas to constructed or natural drainage systems.

Stormwater runoff Rain that flows off the surface of the land without entering the soil.

Structural control A practice that involves design and construction of a facility to mitigate the adverse impact of urban runoff, and often requires maintenance.

Subdivision The process (and the result) of dividing a parcel of raw land into smaller buildable sites, streets, open spaces, and public areas, and the designation of utilities and other improvements. Critical Area regulations govern the density and design of new subdivisions.

Subwatershed A watershed management unit whose boundaries are typically defined as all of the land draining to the point where two second order streams combine together to form a third order stream. A subwatershed may be a few square miles in area, and are the key geographic unit for urban stream classification and watershed-based zoning.

Surface water Water on the surface of the land that has not infiltrated the soil including streams, lakes, rivers, and ponds.

Swale An open drainage channel that has been explicitly designed to detain or infiltrate the entire runoff volume associated with a water quality storm event.

Trip generation rate A statistic that indicates the number of vehicular trips that are taken from an average dwelling unit in a

particular land use category on a typical day. For example, studies have shown that one single family home generates about 10 trips per day.

Unbuildable lands The portions of a development site where structures cannot be located for physical or environmental reasons (e.g., easements, open water, steep slopes, floodplains, wetlands and stream buffers).

Unit Pavers Concrete grid and modular pavement whose spaces are filled with pervious materials such as sod, sand, or gravel.

Water table The upper surface of groundwater or the level below which the soil is saturated with water. The water table indicates the uppermost extent of ground water.

Watershed (see Drainage basin) The geographic region within which water drains into a particular river, stream or body of water. A watershed includes hill, lowlands, and the body of water into which the land drains. Watershed boundaries are defined by the ridges of separating watersheds.

Wet pond Pond for urban runoff management that is designed to detain urban runoff and always contains water.

Zoning A set of regulations and requirements which govern the use, placement, spacing, and size of land and buildings within a specific area (zone).

- Arendt, Randall G. *Conservation Design for Subdivisions*. Washington, D.C.: Island Press, 1996.
- Arnold, Chester L., Jr., and C. James Gibbons. "Impervious Surface Coverage: The Emergence of a Key Environmental Indicator," *Journal of the American Planning Association*, vol. 62, no. 2 (Spring 1996).
- Association of Monterey Bay Area Governments. *Clean Water: Water Quality Management Plan for the Monterey Bay Region*, 1978.
- Association of Bay Area Governments. *Improving Our Bay-Delta Estuary Through Local Plans and Programs: A Guidebook for City and County Governments*, Oakland: ABAG, December, 1995.
- Association of Bay Area Governments. *Manual of Standards for Erosion & Sediment Control Measures*, 2nd ed. ABAG: Oakland, 1995.
- Bay Area Stormwater Management Agencies Association. *San Francisco Bay Area Recyclers and Disposal Services for Construction Sites*; December 1995.
- Bay Area Stormwater Management Agencies Association. *BMP Fact Sheets*. 1997.
- Berman, Laurel, C. Hartline, N. Ryan, J. Thorne. *Urban Runoff: Water Quality Solutions*, APWA Special Report #61; May 1991.
- Bicknell, Jill C. and Lisa Horowitz McCann. *Controlling the Impacts of Development on Storm Water Quality through Proper Site Planning and Design*.
- Cahill Associates Environmental Consultants. "Stormwater Management Systems: Porous pavement system with underground recharge beds," *Engineering Design Report*, Spring, 1993.
- Cahill, Thomas, Cahill Associates Environmental Consultants. "A Second Look at Porous Pavement/Underground Recharge," *Watershed Protection Techniques*, vol. 1, no. 2 (Summer 1994).
- California Regional Water Quality Control Board. *Staff Recommendations for New and Redevelopment Controls for Storm Water Programs*, April 5, 1994.
- California Regional Water Quality Control Board, San Francisco Bay Region. *Directions For Preparing A Storm Water Pollution Prevention Plan*, December, 1995.
- California Stormwater Quality Task Force (Roesner, Walker, et. al.). *California Storm Water Best Management Practice Handbooks*, County of Alameda: 1993.
- Center for Watershed Protection. *Rapid Watershed Planning Handbook: A Comprehensive Guide for Managing Urbanizing Watersheds*. Ellicott City, Maryland, October 1998.
- Chesapeake Bay Critical Area Commission. *Critical Area and You: The Chesapeake's First Line of Defense*.
- Chow, Ven-Te. *Handbook of Applied Hydrology; a compendium of water-resources technology*. New York, McGraw-Hill, 1964.
- City of Dublin Department of Public Works. "California Notice to Contractors Special Provisions Proposal and Contract for Pervious Concrete Project in Dublin," July 1992.
- City of Olympia Public Works Department. *Impervious Surface Reduction Study: Draft Report*, November 1994.
- City of Olympia Public Works Department Water Resources Program. *Impervious Surface Reduction Study Executive Summary*, January 1996.
- City of San Rafael. *Hillside Residential Design Guidelines Manual*, October 1991.
- Department of Defense. *Federal Register Part III Department of Defense - Nationwide Permit Program Regulations and Issue, Reissue, and Modify Nationwide Permits Final Rule*, November 22, 1991.
- Doenges, James M. and others, eds. *Protecting Connecticut's Water-Supply Watersheds: A Guide for Local Officials*, January 1993.

Bibliography, continued

- Environmental Protection Agency. *Methodology for Analysis of Detention Basins for Control of Urban Runoff Quality*, Washington: U.S. Government Printing Office (EPA 440/5-87-001), 1986.
- Environmental Protection Agency (Driscoll, E. D., et. al.). *Analysis of Storm Events: Characteristics for Selected Rainfall Gauges Throughout the United States*, Washington: U.S. Government Printing Office, 1989.
- Environmental Protection Agency. *Federal Register Part VI - National Pollutant Discharge Elimination System Application Deadlines, General Permit Requirements and Reporting Requirements for Storm Water Discharges Associated With Industrial Activity— Final Rule*, April 2, 1992.
- Environmental Protection Agency. *Natural Wetlands and Urban Stormwater: Potential Impacts and Management*, Washington: U.S. Government Printing Office (EPA 843-R-001), Feb. 1993.
- Environmental Protection Agency. “Landscape Design and Maintenance for Pollution Control,” *Rural Nonpoint Source Management*, Washington: U.S. Government Printing Office, February 1994.
- Environmental Protection Agency. *National Conference on Urban Runoff Management: Enhancing Urban Watershed Management at the Local, County, and State Levels* (Seminar Publication), Washington: U.S. Government Printing Office, April 1995.
- Environmental Protection Agency. *Economic Benefits of Runoff Controls*. (EPA-841-S-95-002) Washington: U.S. Government Printing Office, September 1995.
- Environmental Protection Agency. *Protecting Natural Wetlands: A Guide to Stormwater Best Management Practices* (EPA-843-B-96-001), October 1996.
- Environmental Protection Agency. *Urbanization and Streams: Studies of Hydrologic Impacts* (EPA-841-R-97-009), December 1997.
- Environmental Protection Agency. *Federal Register Part II - National Pollutant Discharge Elimination System – Proposed Regulations for Revision of the Water Pollution Control Program Addressing Storm Water Discharges; Proposed Rule*, January 9, 1998.
- Environmental Protection Agency. *Memorandum of Agreement Between the Department of the Army and the Environmental Protection Agency Concerning Federal Enforcement for the Section 404 Program of the Clean Water Act*.
- Ferguson, Bruce K. *Stormwater Infiltration*, Boca Raton: CRC Press, 1994.
- Ferguson, Bruce, Thomas N. Debo. *On-Site Stormwater Management: Application for Landscape and Engineering*, New York: Van Nostrand Reinhold, 1990.
- Florida Concrete & Products Association. “Construction of Portland Cement Pervious Pavement,” n.d. (a training video and booklet).
- Goldman, Steven J. and others. *Erosion and Sediment Control Handbook*, New York: McGraw Hill, 1986.
- Harris, Charles W. and Nicholas T. Dines, co-editors. *Time-Saver Standards for Landscape Architecture, second edition*. McGraw-Hill Publishing Co., New York, 1998.
- Harris, Richard W. *Arboriculture: integrated management of landscape trees, shrubs and vines* (2nd ed.), Englewood Cliffs: Prentice Hall, 1992.
- Institute of Transportation Engineers Technical Committee 5P-8 (Frank L. Spielberg, chair). *Traffic Engineering for Neo-Traditional Neighborhood Design: an informational report*, Washington, DC: ITE, February 1994.
- Kibbey, David, editor. “ADPSR West Coast Architectural Resource Guide,” Draft 12/12/95.
- MacDonald, Lynn. “Pollution Solution: Build a Marsh,” *American Forests*, July/August 1994.
- Milliken, Buddy. “Summary of Proposed Stormwater Management Techniques for The Village of Woodsong” Feb. 1996.
- Mitchell, John G. “Our Polluted Runoff,” *National Geographic*, vol. 189, no. 2 (February 1996).

- Olshansky, Robert B., "Planning for Hillside Development," *Environment & Development*, Sept/Oct 1995.
- Phillips, Nancy J. and Elizabeth T. Lewis. "Site Planning From a Watershed Perspective," Seminar Publication, *National Conference on Urban Runoff Management: Enhancing Urban Watershed Management at the Local, County, and State Levels*, 1993.
- Pitt, Robert Clark, with Shirley Clark, Keith Palmer, Richard Field. *Groundwater Contamination from Stormwater Infiltration*. Ann Arbor Press, Inc., 1996.
- Prince George County, MD, Dept. of Environmental Resources, Division of Environmental Management, Watershed Protection Branch. *Design Manual for Use of Bioretention in Stormwater Management*, June 8, 1993.
- Ramsey, Charles G. & H. R. Sleeper, *Architectural Graphic Standards (Eighth Ed.)*, Somerset, NJ: John Wiley & Sons, 1988.
- Santa Clara Valley Water District. "Wanted: Creative Creekside Street." July 1985.
- Schroeder, Roy A. *Potential for Chemical Transport Beneath a Storm-runoff Recharge (Retention) Basin for an Industrial Catchment in Fresno*. U.S. Geological Survey Water-Resources Investigations Report 93-4140, prepared in cooperation with the Fresno Metropolitan Flood Control District. Sacramento, 1995.
- Schueler, Thomas R. *Controlling Urban Runoff: A Practical Manual for Planning and Designing Urban BMPs*, July, 1987.
- Schueler, Thomas R., Metropolitan Washington Council of Governments. *Controlling Urban Runoff: a practical manual for planning and designing urban BMP's*, July 1987.
- Schueler, Thomas R., Peter A. Kumble, and Maureen A. Heraty. *A Current Assessment of Urban Best Management Practices: Techniques for Reducing Non-Point Source Pollution in the Coastal Zone*, March, 1992.
- Schueler, Thomas R. *The Stream Protection Approach: Guidance for Developing Effective Local Nonpoint Source Control Programs in the Great Lakes Region*, January 1994.
- Schueler, Thomas R., and Richard A. Clayton. *Design of Stormwater Filtering Systems*, The Center for Watershed Protection. December, 1996.
- Schueler, Tom. *Environmental Land Planning Series: Site Planning for Urban Stream Protection*, Washington, DC: Metropolitan Washington Council of Governments (pub. no. 95708), December, 1995.
- South Carolina Coastal Conservation League. "Getting a Rein on Runoff: How Sprawl and the Traditional Town Compare," *SCCL Land Development Bulletin*, Number 7 (Fall, 1995).
- Strom, Steven and Kurt Nathan. *Site Engineering for Landscape Architects*, 2nd ed., New York: Van Nostrand Reinhold, 1993.
- The Terrene Institute. *Handle with Care: Your guide to preventing water pollution*.
- Town of Portola Valley, California. *Design Guidelines*, July, 1989, revised Dec. 1991.
- Urbonas, B.R., and P. Stahre. *Stormwater: Best Management Practices including Detention*, Englewood Cliffs: Prentice Hall, 1993.
- Waller, Roger M. *Ground Water and the Rural Homeowner*, 1994.
- Water Environment Federation and American Society of Civil Engineers. *Urban Runoff Quality Management* (WEF Manual of Practice No. 23 and ASCE Manual and Report on Engineering Practice No. 87), jointly published by American Society of Civil Engineers (ASCE) and the Water Environment Federation (WEF). Alexandria, VA: WEF, and New York: ASCE, 1998.
- Watershed Protection Techniques: A Quarterly Bulletin on Urban Watershed Restoration and Protection Tools*. Vol.1, No.3 – Fall 1994; Fall, 1994; Vol.2, No.1 – Fall 1995; Fall 1995.
- Woodward-Clyde Consultants. *Parking Lot BMP Manual*, Santa Clara Valley Nonpoint Source Pollution Control Program, June 11, 1996.

- ¹ Environmental Protection Agency, *Natural Wetlands and Urban Stormwater: Potential Impacts and Management*, EPA document 843-R-001, Feb. 1993, p. 76
- ² U.S. EPA Urbanization and Streams: Studies of Hydrologic Impacts. EPA doc. 841-R-97-009 Dec. 1997.
- ³ U.S. EPA National Water Quality Inventory, Report to Congress, 1994.
- ⁴ Federal Register Vol. 55, No. 222, 47990-48091, Nov. 16, 1990.
- ⁵ California Regional Water Quality Control Board (Region 2), *Water Quality Control Plan for the San Francisco Bay Basin*. Oakland, CA, 1995.
- ⁶ this discussion is adapted from: Arnold, Jr., Chester L. and C. James Gibbons, "Impervious surface coverage: the emergence of a key environmental indicator," *APA Journal*, 62,2: 243-257, and Schueler, Tom, *Environmental Land Planning Series: Site planning for urban stream protection (1995)*, 19-20.
- ⁷ Schueler, Tom. Site Planning for Urban Stream Protection, 1995, pp. 42-43.
- ⁸ Environmental Protection Agency, *Natural Wetlands and Urban Stormwater: Potential Impacts and Management*, p. 76.
- ⁹ Stegner, Wallace. *Where the Bluebird Sings to the Lemonade Springs*, p. 50-51.
- ¹⁰ Schueler, Tom. Site Planning for Urban Stream Protection, 1995. pp. 55-82.
- ¹¹ personal measurements by Tom Richman, 1996
- ¹² Schueler, p. 148.
- ¹³ this discussion of traffic volumes and costs related to access streets is adapted from Schueler, p. 148.
- Recent household survey data indicates that the 10 vehicle per day per household rule-of-thumb overestimates actual vehicle trips, especially in neo-traditional neighborhoods where multiple modes of transportation are supported. This suggests that two-way "access streets" with shared central moving space may safely serve more than 50 residential units. Frank Spielberg, ITE Technical Review Committee, personal communication, 1996.
- ¹⁴ *ibid.* The term "headwater streets" has been popularized by Tom Schueler of the Center for Watershed Protection.
- ¹⁵ Schueler, p. 148.
- ¹⁶ Spielberg, Frank ITE Technical Review Committee, personal communication
- ¹⁷ City of Olympia, 1994, p. 92-94.
- ¹⁸ Urban Land Institute. Shared parking manual, 1983.
- The Dimensions of Parking, 3rd ed. ULI, NPA, 1994
- Planning, June 1997, vol 63, no. 6, p. 10-15.
- Shoup, Donald C. The high cost of free parking. *Journal of Planning Education and Research*, 17:3-20, 1997.
- Shoup, Donald C. An opportunity to reduce minimum parking requirements., *Journal of the American Planning Assoc.*, Vol. 61, no. 1, Winter, 1995, pp. 14-28.
- ¹⁹ Thayer, Robert L., personal communication, 1996.
- ²⁰ Urbonas and Stahre. *Stormwater, Best Management Practices including Detention*, 1993.
- ²¹ Water Environment Federation. *Urban Runoff Water Management*, 1996.
- ²² U.S. Soil Conservation Service, 1987, *Urban Hydrology for Small Watersheds: Technical Release 55*, Washington: U.S. SCS.
- ²³ Chow, Ven-Te, ed. *Handbook of Applied Hydrology*. New York: McGraw-Hill, 1964. pg. 12-26 (Infiltration section).
- ²⁴ Pitt, 1996, pp.13,29,49,51, 53, 91-93 and Stormwater Task Force, California Stormwater BMP Handbooks, Industrial Handbook.
- ²⁵ Schroeder, 1995.
- ²⁶ Environmental Protection Agency. "Landscape Design and Maintenance for Pollution Control," *Rural Nonpoint Source Management*, 1994.
- ²⁷ Springer, William. Santa Clara Valley Nonpoint Source Pollution Control Program, personal communication, 1996 and December 23, 1998 letter to Wendy Edde (EOA, Inc.) from Ellen Fostersmith (SCVWD).
- ²⁸ Springer, William. Santa Clara Valley Nonpoint Source Pollution Control Program, personal communication, 1996.
- ²⁹ Stormwater Task Force, California Stormwater BMP Handbooks, Municipal Handbook, 5-3.
- ³⁰ Woodward-Clyde. *Parking lot BMP Manual*.
- ³⁰ Alexandria Supplement to the Northern Virginia BMP Handbook, 1992.
- ³¹ Ferguson (1994), p. 53.
- ³² Florida Concrete Products Association, video.
- ³³ California Department of Transportation, *Standard Specifications*, Sec. 39, 1995.
- ³⁴ Ferguson, personal conversation based on 1996 site inspection.
- ³⁵ Ramsey & Sleeper, *Architectural Graphic Standards*, p. 105.
- ³⁶ *ibid.* and Ferguson, 1998, p. 54
- ³⁷ Ferguson, 1994, p. 52.
- ³⁸ *ibid.*
- ³⁹ Ferguson, 1994.
- ⁴⁰ City of Olympia, 1994, p. 30. In one of the few studies that actually measured impervious surface coverage, the City of Olympia (WA) found that the street and circulation network accounted for an average of 63 to 70% of total impervious coverage in a selection of eight single family and multifamily residential developments. Also see Schueler, Tom (1995), p. 19.
- ⁴¹ Santa Clara Valley Nonpoint Source Pollution Control Program, *Source Identification and Control Report*, 1996.
- ⁴² Headwaters Streets: Schueler (1995), ad passim. Institute for Transportation Engineering, *Traffic Engineering for Neo-Traditional Neighborhood Design*.
- ⁴³ ITE, "Traffic Engineering for Neo-Traditional Neighborhood Design: an informational report," February 1994. This report "does not include Institute recommendations on the best course of action," and is a survey obtained from transportation engineering professionals and research. A technical committee of the ITE is currently considering neo-traditional street design standards for adoption by the ITE.
- ⁴⁴ *ibid.*
- ⁴⁵ Ferguson (1994), p. 18.
- ⁴⁶ Ferguson (1994), p. 14
- ⁴⁷ Harris, p. 48

⁴⁸ Harris, p. 621

⁴⁹ Stormwater Pollution Prevention Plan. Construction of San Pedro Avenue Extension in the City of Pacifica. Prepared by Wilsey & Ham. August, 1995

⁵⁰ *ibid.*

⁵¹ Santa Clara Valley Nonpoint Source Pollution Control Program. Duke, L.D. and Shannon, J.A. Best Management Practices for Industrial Storm Water Pollution Control. 1992.

⁵² Santa Clara Valley Nonpoint Source Pollution Control Program, 1992 and Stormwater Pollution Prevention Plan, 1995.

⁵³ Stormwater Pollution Prevention Plan, 1995, and Industrial/Commercial Best Management Practice Handbook. California Storm Water Best Management Practice Handbooks. March 1993. Camp Dresser McKee for Stormwater Quality Task Force

⁵⁴ Stormwater Pollution Prevention Plan, 1995.

⁵⁵ City of Burlingame Storm Water Pollution Protection Standard Specifications.

⁵⁶ Environmental Protection Agency. *Economic Benefits of Run-off Controls*. (EPA 841-S-95-002), 1995.

⁵⁷ Liptan, Tom and Carmel Kinsella Brown, "A Cost Comparison of Conventional and Water Quality-Based Stormwater Designs," Urban Stormwater Management in the Southwest Conference, Long Beach, CA, 1998.

Finding that the way we design and build communities has a direct effect on water quality, the Bay Area Stormwater Management Agencies Association (BASMAA) has prepared **Start at the Source**, a manual that aims to help designers, developers, and municipal agencies create communities that achieve water quality goals.

The *Site Planning & Design Guidance Manual* contains introductory information on hydrology, watersheds, the importance of minimizing impervious land coverage, zoning and planning strategies for stream protection, and conceptual examples of dozens of methods for integrating stormwater management into all kinds of projects, including new development, infill, and redevelopment.

A **new technical section** presents detailed information on a wide variety of designs that can be adapted to residential, commercial, industrial and institutional projects.

This document recognizes that the one of the best opportunities to reduce the generation of urban runoff or nonpoint source pollution is through planning and design.

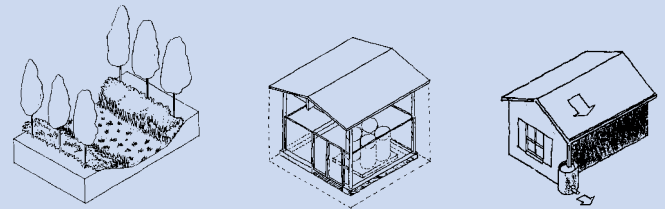

“The more we study stormwater runoff, the more we realize the critical role site planning and design play in our ability to reduce the impacts of development on the quality of our nation’s waters. This manual is a significant step in teaching planners and developers to plan for water quality.”

Thomas E. Mumley

California Regional Water Quality Control Board

San Francisco Bay Region

Urban Runoff Program Manager

“BASMAA’s *Start at the Source* guidance manual is a pioneering effort which focuses on the importance of considering storm water quality in the early stages of planning new residential development in the San Francisco Bay area.”

Community Planning & Environmental Committee

**Consulting Engineers and Land Surveyors
of California (CELSOC)**

“Through its integrative approach and illustrative method, *Start at the Source* shows how new development can be designed and built to meet functional and market demands while protecting water resources.”

Jim Dalton, Executive Vice President

American Society of Landscape Architects